

**General use and economy type.
DIP (1 Form B) 4-pin type.
Reinforced insulation
5,000V type.**

GU-E PhotoMOS (AQY41○EH)

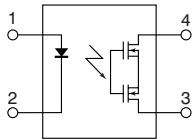
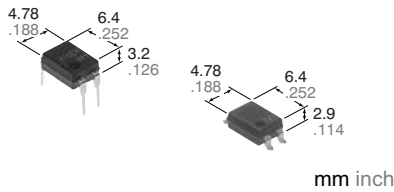

The attainment of economical pricing will broaden its market even further.

3. Normally closed type (1 Form B) is low on-resistance.
(All AQ○4 PhotoMOS are Form B types. And also the Form A types have a low on-resistance.)

This has been realized thanks to the built-in MOSFET processed by our proprietary method, DSD (Double-diffused and Selective Doping) method. Cross section of the normally-closed type of power MOS

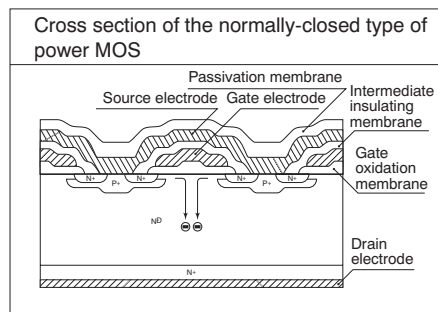

4. Reinforced insulation 5,000 V type
 More than 0.4 mm internal insulation distance between inputs and outputs. Conforms to EN41003, EN60950 (reinforced insulation).

5. Compact 4-pin DIP size

The device comes in a compact (W)6.4×(L)4.78×(H)3.2mm (W).252×(L).188×(H).126inch, 4-pin DIP size

6. Controls low-level analog signals
 PhotoMOS relays feature extremely low closed-circuit offset voltage to enable control of low-level analog signals without distortion.

7. High sensitivity, low ON resistance
 Can control a maximum 0.13 A load current with a 5 mA input current. Low ON resistance of 18Ω (AQY410EH). Stable operation because there are no metallic contact parts.

6. Low-level off-state leakage current

FEATURES

1. 60V type couples high capacity (0.55A) with low on-resistance (1Ω)

Item	GU-E type	
Part No.	AQY410EH	AQY412EH
Load voltage	350V	60V
Continuous load current	0.13A	0.55A
ON resistance (typ.)	18Ω	1Ω

2. This is the low-cost version PhotoMOS 1 Form B output type relay.

TYPICAL APPLICATIONS

- Power supply
- Measuring equipment
- Security equipment
- Modem
- Telephone equipment
- Electricity, plant equipment
- Sensors

TYPES

Type	I/O isolation voltage	Output rating*		Part No.				Packing quantity	
				Through hole terminal	Surface-mount terminal		Tube	Tape and reel	
					Tube packing style				Tape and reel packing style
AC/DC type	Reinforced 5,000 V	Load voltage	Load current	AQY412EH	AQY412EHA	AQY412EHAX	AQY412EHAZ	1 tube contains 100 pcs. 1 batch contains 1,000 pcs.	1,000 pcs.
		60 V	550 mA	AQY410EH	AQY410EHA	AQY410EHAX	AQY410EHAZ		
		350 V	130 mA	AQY414EH	AQY414EHA	AQY414EHAX	AQY414EHAZ		
		400 V	120 mA						

*Indicate the peak AC and DC values.

Note: For space reasons, the initial letters of the part number "AQY", the SMD terminal shape indicator "A" and the package style indicator "X" or "Z" are not marked on the relay.

RATING

1. Absolute maximum ratings (Ambient temperature: 25°C 77°F)

Item		Symbol	AQY412EH (A)	AQY410EH (A)	AQY414EH (A)	Remarks
Input	LED forward current	I _F	50 mA			
	LED reverse voltage	V _R	5 V			
	Peak forward current	I _{FP}	1 A			f = 100 Hz, Duty factor = 0.1%
	Power dissipation	P _{in}	75 mW			
Output	Load voltage (peak AC)	V _L	60 V	350 V	400 V	
	Continuous load current	I _L	0.55 A	0.13 A	0.12 A	
	Peak load current	I _{peak}	1.5 A	0.4 A	0.3 A	100 ms (1 shot), V _L = DC
	Power dissipation	P _{out}	500 mW			
Total power dissipation		P _T	550 mW			
I/O isolation voltage		V _{iso}	5,000 V AC			
Temperature limits	Operating	T _{opr}	-40°C to +85°C -40°F to +185°F			Non-condensing at low temperatures
	Storage	T _{stg}	-40°C to +100°C -40°F to +212°F			

GU-E PhotoMOS (AQY410EH)

2. Electrical characteristics (Ambient temperature: 25°C 77°F)

Item		Symbol	AQY412EH (A)	AQY410EH (A)	AQY414EH (A)	Condition
Input	LED operate (OFF) current	Typical	1.4 mA			I _L =Max.
		Maximum	3.0 mA			
	LED reverse (ON) current	Minimum	0.4 mA			I _L =Max.
		Typical	1.3 mA			
LED dropout voltage	Typical	1.25 (1.14 V at I _F = 5 mA)			I _F = 50 mA	
	Maximum	1.5 V				
Output	On resistance	Typical	1Ω	18Ω	26Ω	I _F = 0 mA I _L = Max. Within 1 s on time
		Maximum	2.5Ω	25Ω	35Ω	
	Off state leakage current	Maximum	10μA			I _F = 5 mA V _L = Max.
Transfer characteristics	Operate (OFF) time*	Typical	3.0 ms	1.0 ms	0.8 ms	I _F = 0 mA > 5 mA I _L = Max.
		Maximum	10.0 ms	3.0 ms		
	Reverse (ON) time*	Typical	0.2 ms	0.3 ms	0.2 ms	I _F = 5 mA > 0 mA I _L = Max.
		Maximum	1.0 ms			
I/O capacitance	Typical	0.8 pF			f = 1MHz V _B = 0 V	
	Maximum	1.5 pF				
Initial I/O isolation resistance	Minimum	R _{iso}	1,000MΩ			500 V DC

Note: Recommendable LED forward current I_F = 5 to 10mA.

[Type of connection](#)

*Operate/Reverse time

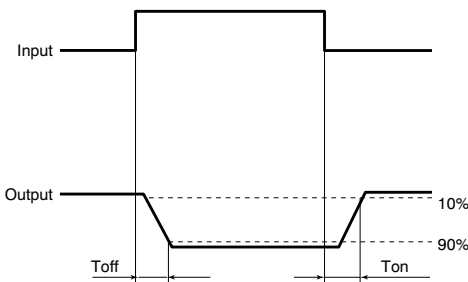

- [Dimensions](#)
- [Schematic and Wiring Diagrams](#)
- [Cautions for Use](#)

REFERENCE DATA

1-(1). Load current vs. ambient temperature characteristics

Allowable ambient temperature: -40°C to +85°C
-40°F to +185°F

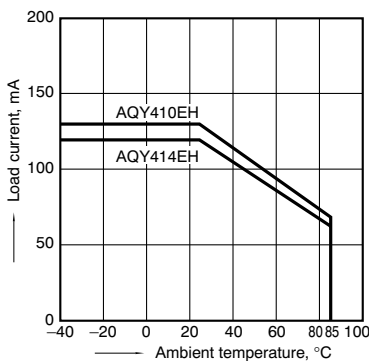

1-(2). Load current vs. ambient temperature characteristics

Allowable ambient temperature: -40°C to +85°C
-40°F to +185°F

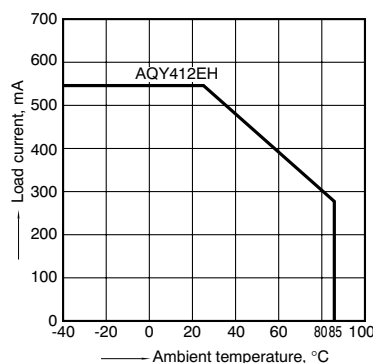

2. On resistance vs. ambient temperature characteristics

Measured portion: between terminals 3 and 4;
LED current: 0 mA; Load voltage: Max. (DC);
Continuous load current: Max. (DC)

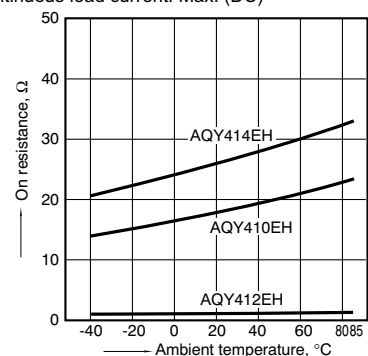

3. Operate (OFF) time vs. ambient temperature characteristics

LED current: 5 mA; Load voltage: Max. (DC);
Continuous load current: Max. (DC)

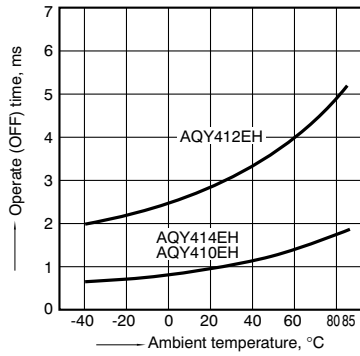

4. Reverse (ON) time vs. ambient temperature characteristics

LED current: 5 mA; Load voltage: Max. (DC);
Continuous load current: Max. (DC)

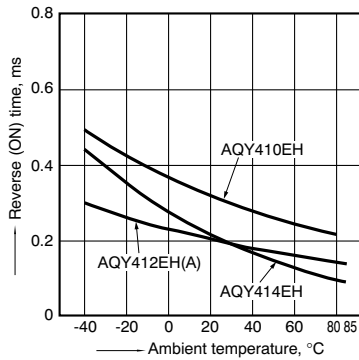

5. LED operate (OFF) current vs. ambient temperature characteristics

Sample: All types;
Load voltage: Max. (DC);
Continuous load current: Max. (DC)

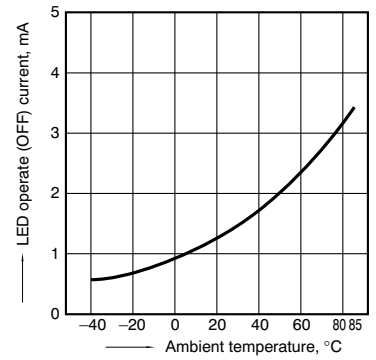

6. LED reverse (ON) current vs. ambient temperature characteristics

Sample: All types;
Load voltage: Max. (DC);
Continuous load current: Max. (DC)

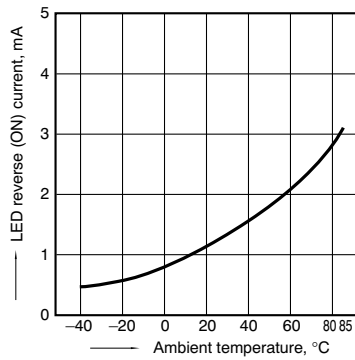

7. LED dropout voltage vs. ambient temperature characteristics

LED current: 5 to 50 mA

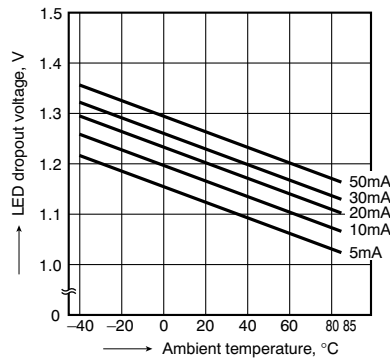

8-(1). Current vs. voltage characteristics of output at MOS portion

Measured portion: between terminals 3 and 4;
Ambient temperature: 25°C 77°F

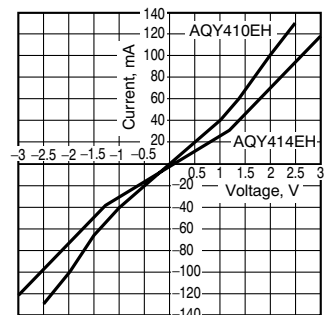

8-(2). Current vs. voltage characteristics of output at MOS portion

Measured portion: between terminals 3 and 4;
Ambient temperature: 25°C 77°F

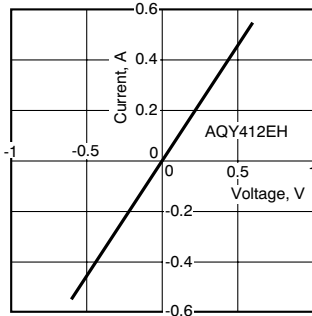

9. Off state leakage current vs. load voltage characteristics

Measured portion: between terminals 3 and 4;
Ambient temperature: 25°C 77°F

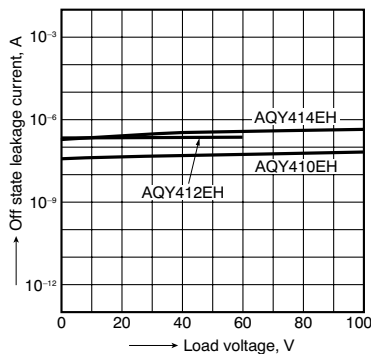

10. Operate (OFF) time vs. LED forward current characteristics

Measured portion: between terminals 3 and 4;
Load voltage: Max. (DC); Continuous load current: Max. (DC);
Ambient temperature: 25°C 77°F

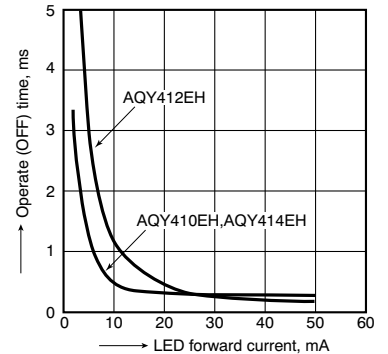

11. Reverse (ON) time vs. LED forward current characteristics

Measured portion: between terminals 3 and 4;
Load voltage: Max. (DC); Continuous load current: Max. (DC);
Ambient temperature: 25°C 77°F

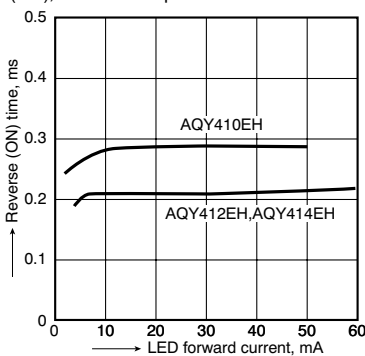

12. Output capacitance vs. applied voltage characteristics

Measured portion: between terminals 3 and 4;
Frequency: 1 MHz; Ambient temperature: 25°C 77°F

