

## 4-Line BUS-Port ESD Protection

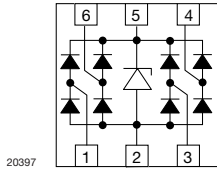

20397

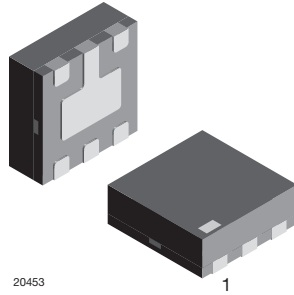

20453

1

### FEATURES

- Ultra compact LLP75-6L package
- Low package height < 0.6 mm
- 4-line USB ESD protection
- Low leakage current
- Low load capacitance  $C_D = 0.8$  pF
- ESD immunity acc. IEC 61000-4-2  
± 15 kV contact discharge  
± 15 kV air discharge
- e4 - precious metal (e.g. Ag, Au, NiPd, NiPdAu) (no Sn)
- Material categorization: for definitions of compliance please see [www.vishay.com/doc?99912](http://www.vishay.com/doc?99912)



### MARKING (example only)

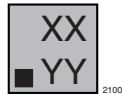

Dot = pin 1 marking

XX = date code

YY = type code (see table below)

### DESIGN SUPPORT TOOLS

[click logo to get started](#)

ORDERING INFORMATION			
DEVICE NAME	ORDERING CODE	TAPED UNITS PER REEL (8 mm TAPE ON 7" REEL)	MINIMUM ORDER QUANTITY
VBUS054B-HSF	VBUS054B-HSF-GS08	3000	15 000

PACKAGE DATA						
DEVICE NAME	PACKAGE NAME	TYPE CODE	WEIGHT	MOLDING COMPOUND FLAMMABILITY RATING	MOISTURE SENSITIVITY LEVEL	SOLDERING CONDITIONS
VBUS054B-HSF	LLP75-6L	U3	4.2 mg	UL 94 V-0	MSL level 1 (according J-STD-020)	Peak temperature max. 260 °C

ABSOLUTE MAXIMUM RATINGS				
PARAMETER	TEST CONDITIONS	SYMBOL	VALUE	UNIT
Peak pulse current	Pin 1, 3, 4 or 6 to pin 2 acc. IEC 61000-4-5; $t_p = 8/20$ $\mu$ s; single shot	$I_{PPM}$	3	A
	Pin 5 to pin 2 acc. IEC 61000-4-5; $t_p = 8/20$ $\mu$ s; single shot	$I_{PPM}$	10	A
Peak pulse power	Pin 1, 3, 4 or 6 to pin 2 acc. IEC 61000-4-5; $t_p = 8/20$ $\mu$ s; single shot	$P_{PP}$	45	W
	Pin 5 to pin 2 acc. IEC 61000-4-5; $t_p = 8/20$ $\mu$ s; single shot	$P_{PP}$	200	W
ESD immunity	Contact discharge acc. IEC61000-4-2; 10 pulses	$V_{ESD}$	± 15	kV
	Air discharge acc. IEC61000-4-2; 10 pulses	$V_{ESD}$	± 15	kV
Operating temperature	Junction temperature	$T_J$	-40 to +125	°C
Storage temperature		$T_{STG}$	-55 to +150	°C



ELECTRICAL CHARACTERISTICS VBUS054B-HSF						
PARAMETER	TEST CONDITIONS/REMARKS	SYMBOL	MIN.	TYP.	MAX.	UNIT
Protection paths	Number of line which can be protected	$N_{channel}$	-	-	4	lines
Reverse stand-off voltage	at $I_R = 0.1 \mu A$ , pin 1, 3, 4 or 6 to pin 2	$V_{RWM}$	-	-	5	V
Reverse current	at $V_{IN} = V_{RWM} = 5 V$ , pin 1, 3, 4 or 6 to pin 2	$I_R$	-	< 0.01	0.1	$\mu A$
Reverse breakdown voltage	at $I_R = 1 mA$ , pin 5 to pin 2	$V_{BR}$	6.3	7.1	8	V
	at $I_R = 1 mA$ , pin 1, 3, 4 or 6 to pin 2	$V_{BR}$	6.9	7.9	8.7	V
Reverse clamping voltage	at $I_{PP} = 3 A$ ; pin 1, 3, 4 or 6 to pin 2; acc. IEC 61000-4-5	$V_C$	-	-	15	V
Forward clamping voltage	at $I_F = 3 A$ ; pin 2 to pin 1, 3, 4 or 6; acc. IEC 61000-4-5	$V_F$	-	-	5	V
Capacitance	Pin 1, 3, 4 or 6 to pin 2 $V_{IN}$ (at pin 1, 3, 4 or 6) = 0 V and $V_{BUS}$ (at pin 5) = 5 V; $f = 1 MHz$	$C_D$	-	0.8	1	pF
	Pin 1, 3, 4 or 6 to pin 2 $V_{IN}$ (at pin 1, 3, 4 or 6) = 2.5 V and $V_{BUS}$ (at pin 5) = 5 V; $f = 1 MHz$	$C_D$	-	0.5	0.8	pF
Line symmetry	Difference of the line capacitances	$dC_D$	-	-	0.05	pF
Supply line capacitance	Pin 5 to pin 2; at $V_R = 0$ ; $f = 1 MHz$	$C_{ZD}$	-	110	-	pF

**Note**

- Ratings at 25 °C, ambient temperature unless otherwise specified

**TYPICAL CHARACTERISTICS** ( $T_{amb} = 25 \text{ }^\circ\text{C}$ , unless otherwise specified)

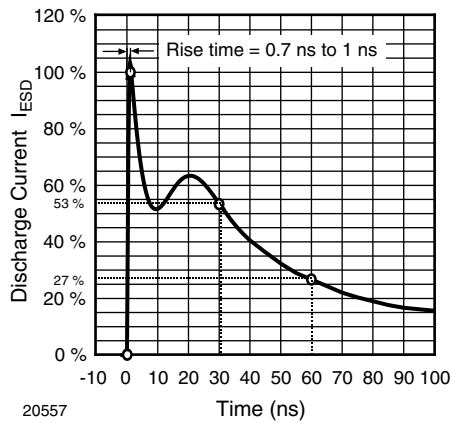

Fig. 1 - ESD Discharge Current Wave Form  
acc. IEC 61000-4-2 (330  $\Omega$ /150 pF)

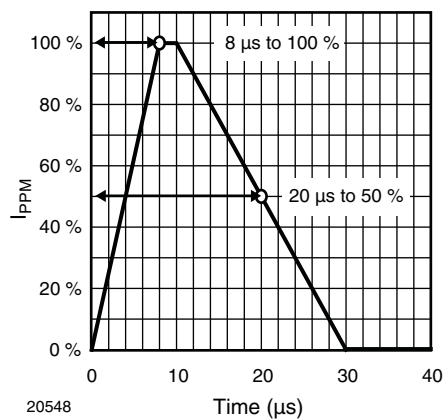

Fig. 2 - 8/20  $\mu s$  Peak Pulse Current Wave Form  
acc. IEC 61000-4-5

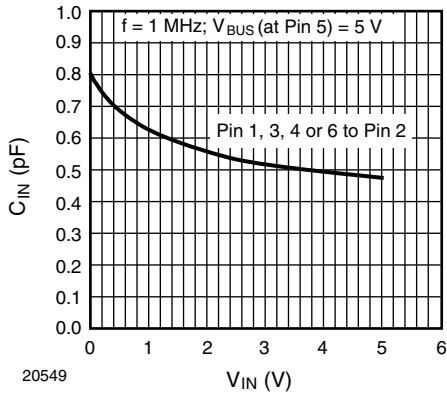

Fig. 3 - Typical Input Capacitance  $C_{IN}$  at Pin 1, 3, 4, or 6 vs. Input Voltage  $V_{IN}$

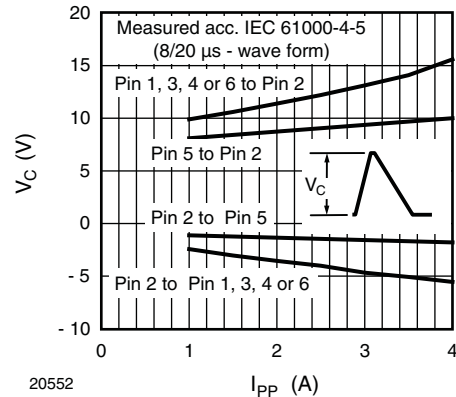

Fig. 6 - Typical Peak Clamping Voltage  $V_C$  vs. Peak Pulse Current  $I_{PP}$

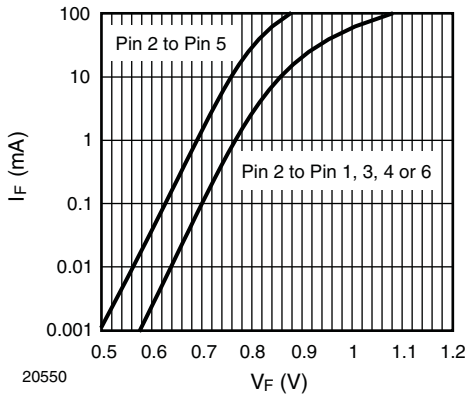

Fig. 4 - Typical Forward Current  $I_F$  vs. Forward Voltage  $V_F$

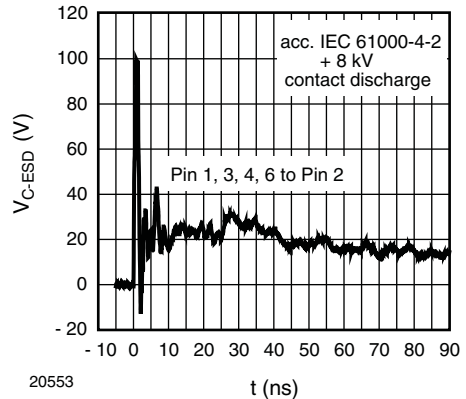

Fig. 7 - Typical Clamping Performance at + 8 kV Contact Discharge (acc. IEC 61000-4-2)

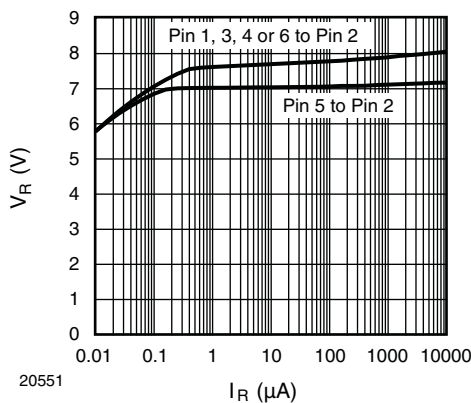

Fig. 5 - Typical Reverse Voltage  $V_R$  vs. Reverse Current  $I_R$

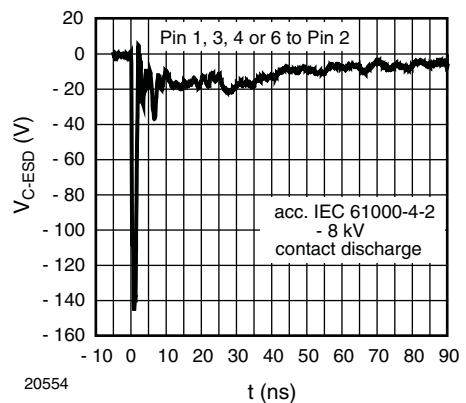

Fig. 8 - Typical Clamping Performance at - 8 kV Contact Discharge (acc. IEC 61000-4-2)

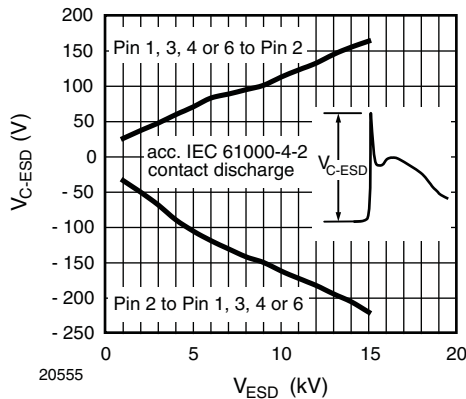

Fig. 9 - Typical Peak Clamping Voltage at ESD Contact Discharge (acc. IEC 61000-4-2)

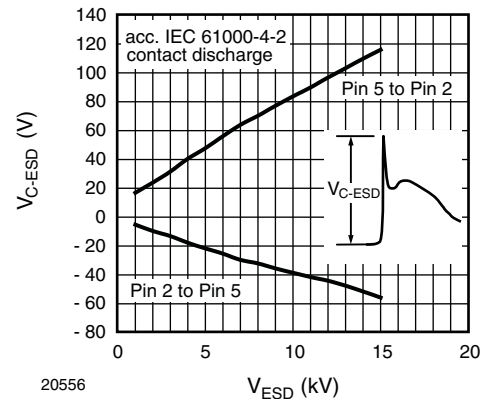
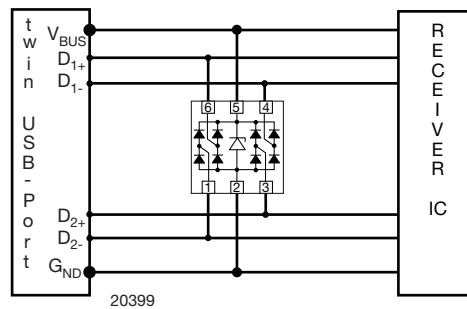

Fig. 10 - Typical Peak Clamping Voltage at ESD Contact Discharge (acc. IEC 61000-4-2)

**APPLICATION NOTE**

With the **VBUS054B-HSF** a double, high speed USB-port or up to 4 other high speed signal or data lines can be protected against transient voltage signals. Negative transients will be clamped close below the ground level while positive transients will be clamped close above the 5 V working range. An avalanche diode clamps the supply line ( $V_{BUS}$  at pin 5) to ground (pin 2). The high speed data lines,  $D_{1+}$ ,  $D_{2+}$ ,  $D_{1-}$  and  $D_{2-}$ , are connected to pin 1, 3, 4 and 6. As long as the signal voltage on the data lines is between the ground- and the  $V_{BUS}$ -level, the low capacitance PN-diodes offer a very high isolation to  $V_{BUS}$ , ground and to the other data lines. But as soon as any transient signal exceeds this working range, one of the PN-diodes starts working in the forward mode and clamps the transient to ground or to the avalanche breakthrough voltage level of the Z-diode between pin 5 and pin 2.



**BACKGROUND KNOWLEDGE:**

A Zener- or avalanche diode is an ideal device for “cutting” or “clamping” voltage spikes or voltage transients down to low and uncritical voltage values. The breakthrough voltage can easily be adjusted by the chip-technology to any desired value within a wide range. Up to about 6 V the “Zener-effect” (tunnel-effect) is responsible for the breakthrough characteristic. Above 6 V the so-called “avalanche-effect” is responsible. This is a more abrupt breakthrough phenomenon. Because of the typical “Z-shape” of the current-voltage-curve of such diodes, these diodes are generally called “Z-diode” (= Zener or avalanche diodes). An equally important parameter for a protection diode is the ESD and surge-power that allows the diode to short current in the pulse to ground without being destroyed.

This requirement can be adjusted by the size of the silicon chip (crystal). The bigger the active area the higher the current that the diode can short to ground.

But the active area is also responsible for the diode capacitance - the bigger the area the higher the capacitance.

The dilemma is that a lot of applications require an effective protection against more than 8 kV ESD while the capacitance must be lower than 5 pF! This is well out of the normal range of a Z-diode. However, a protection diode with a low capacitance PN-diode (switching diode or junction diode) in series with a Z-diode, can fulfil both requirements simultaneously: low capacitance AND high ESD and / or surge immunity become possible!

A small signal ( $V_{pp} < 100$  mV) just sees the low capacitance of the PN-diode, while the big capacitance of the Z-diode in series remains “invisible”.

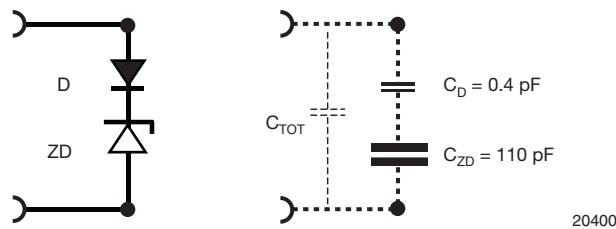

Such a constellation with a Z-diode and a small PN-diode (with low capacitance) in series (anti-serial) is a real unidirectional protection device. The clamping current can only flow in one direction (forward) in the PN-diode. The reverse path is blocked.

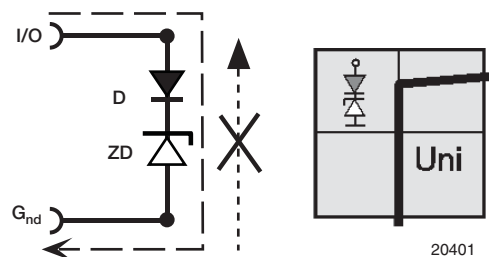

Another PN-diode “opens” the back path so that the protection device becomes bidirectional! Because the clamping voltage levels in forward and reverse directions are different, such a protection device has a **B**idirectional and **A**symmetrical clamping behavior (**BiAs**) just like a single Z-diode.

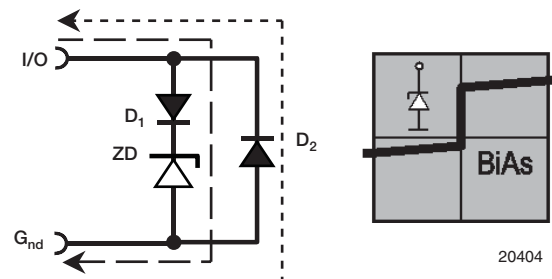

One mode of use is,...

in the very first moment before any pulses have arrived, all three diodes are completely discharged (so the diode capacitances are empty of charge) the first signal pulse with an amplitude  $> 0.5\text{ V}$  will drive the upper PN-diode ( $D_1$ ) in a forward direction and “sees” the empty capacitance of the Z-diode (ZD).

Depending on the duration of this pulse and the pause to the next one the Z-diodes capacitance can be charged up so that the next pulse “sees” a lower capacitance. After some pulses the big Z-diode could be completely charged up so that the following pulses just see the small capacitance of both PN-diodes.

For some application this can work perfectly.....

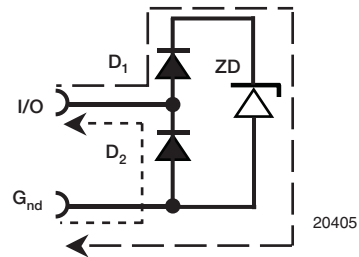

For others applications the capacitance must be the same all the time from the first till the last pulse.

For these applications the appropriate mode of use is to connect the Z-diode to the supply voltage.

In this mode the Z-diode is charged up immediately by the supply voltage and both PN-diodes are always used in reverse. This keeps their capacitance at a minimum.

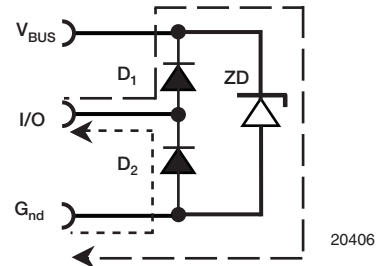



PACKAGE DIMENSIONS in millimeters (inches): **LLP75-6L**

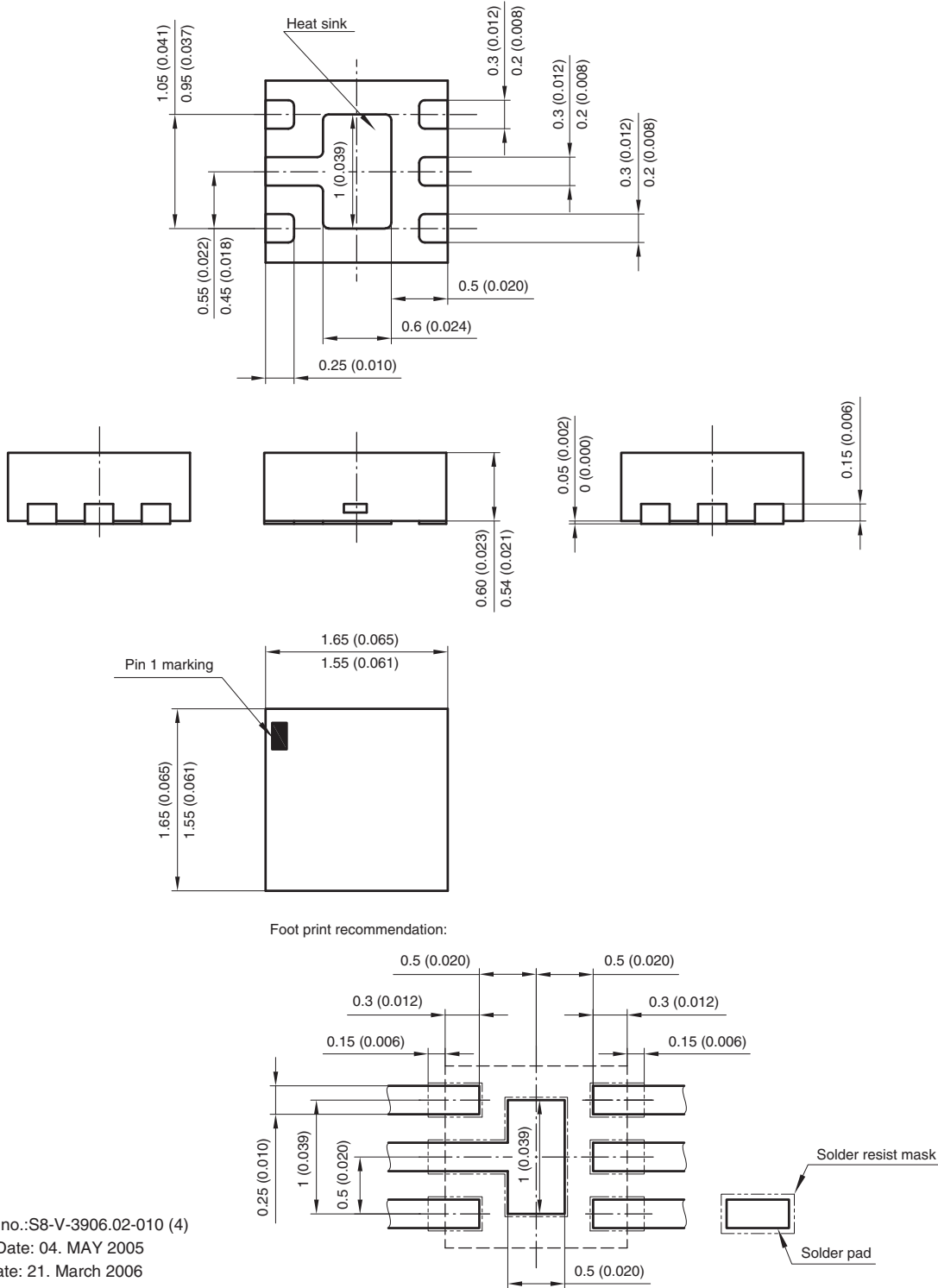

Document no.:S8-V-3906.02-010 (4)  
 Created - Date: 04. MAY 2005  
 Rev. 4 - Date: 21. March 2006  
 20454

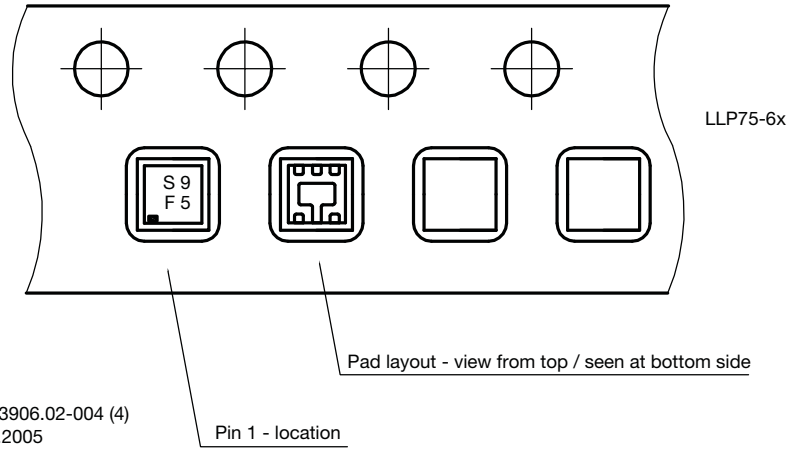

S8-V-3906.02-004 (4)  
10.01.2005





## **Disclaimer**

ALL PRODUCT, PRODUCT SPECIFICATIONS AND DATA ARE SUBJECT TO CHANGE WITHOUT NOTICE TO IMPROVE RELIABILITY, FUNCTION OR DESIGN OR OTHERWISE.

Vishay Intertechnology, Inc., its affiliates, agents, and employees, and all persons acting on its or their behalf (collectively, "Vishay"), disclaim any and all liability for any errors, inaccuracies or incompleteness contained in any datasheet or in any other disclosure relating to any product.

Vishay makes no warranty, representation or guarantee regarding the suitability of the products for any particular purpose or the continuing production of any product. To the maximum extent permitted by applicable law, Vishay disclaims (i) any and all liability arising out of the application or use of any product, (ii) any and all liability, including without limitation special, consequential or incidental damages, and (iii) any and all implied warranties, including warranties of fitness for particular purpose, non-infringement and merchantability.

Statements regarding the suitability of products for certain types of applications are based on Vishay's knowledge of typical requirements that are often placed on Vishay products in generic applications. Such statements are not binding statements about the suitability of products for a particular application. It is the customer's responsibility to validate that a particular product with the properties described in the product specification is suitable for use in a particular application. Parameters provided in datasheets and / or specifications may vary in different applications and performance may vary over time. All operating parameters, including typical parameters, must be validated for each customer application by the customer's technical experts. Product specifications do not expand or otherwise modify Vishay's terms and conditions of purchase, including but not limited to the warranty expressed therein.

Except as expressly indicated in writing, Vishay products are not designed for use in medical, life-saving, or life-sustaining applications or for any other application in which the failure of the Vishay product could result in personal injury or death. Customers using or selling Vishay products not expressly indicated for use in such applications do so at their own risk. Please contact authorized Vishay personnel to obtain written terms and conditions regarding products designed for such applications.

No license, express or implied, by estoppel or otherwise, to any intellectual property rights is granted by this document or by any conduct of Vishay. Product names and markings noted herein may be trademarks of their respective owners.