

MSUD VALVE PLUG FORM A 18MM

PUR 4X0.75 GRAY, 6m

Form A (18 mm)
230 V AC/DC

Further cable lengths on request. Plastic housings with good resistance against chemicals and oils. The resistance to aggressive media should be individually tested for your application. Further details on request.

[Link to Product](#)

Illustration

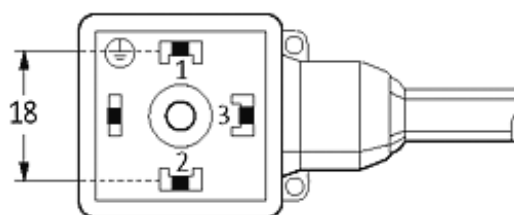
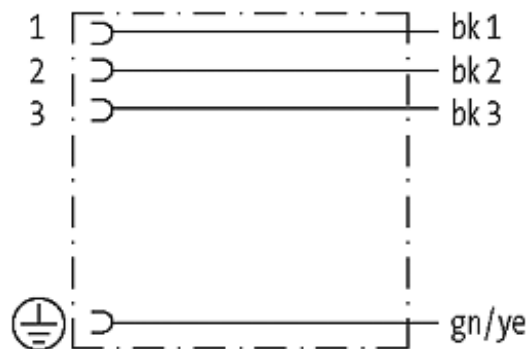

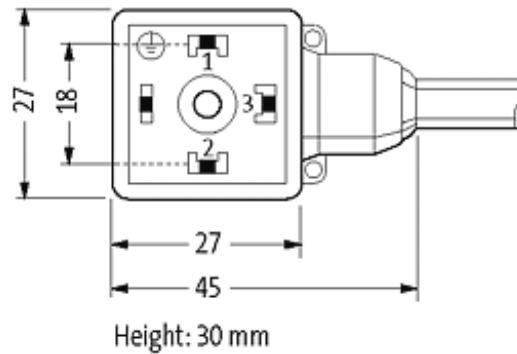

Product may differ from Image

Approvals



Form

18111

Technical Data

Operating voltage	max. 230 V AC/DC
Operating current per contact	max. 10 A
Locking of ports	M3 (recommended torque 0.4 Nm)
Housing	Black plastic (gray on request)
Protection	IP67 inserted and tightened (EN 60529)

Cables

Cable number	227
No./diameter of wires	4 × 0.75 mm ²
Wire isolation	PVC (bk, num, gnye)
C-track properties	2 Mio.
Jacket Color	gray
Shore hardness outer jacket	85 ± 5A
Material (jacket)	PUR/PVC (UL/CSA)
Outer diameter	approx. 7.0 mm
Bend radius (fixed)	10 × outer Ø
Bend radius (moving)	15 × outer Ø
Temperature range (fixed)	-30...+80 °C
Temperature range (mobile)	-5...+80 °C

Commercial data

country of origin	CZ
customs tariff number	85444290
minimum order quantity	1