



Rating	16A 125VAC	  	Mounting Hole	
	10A 250VAC 10A 125VAC 6A 250VAC			
Contact Resistance	50m ohm Max.		  Thickness: 2.0~3.0 Thickness: 0.7~3.0	
Insulation Resistance	DC 500V 100M ohm Min.			
Dielectric Strength	AC 1500V 1 minute			
Operation Temperature	-20°C~85°C			
Switch Function	2P SPST ON-OFF			

Material:

Frame: White Gloss finish, Nylon#66

Actuator: White Gloss finish, Nylon#66

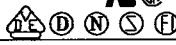
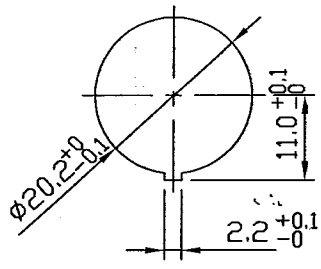
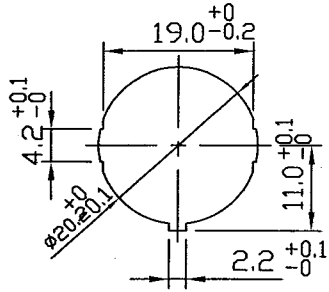
Circuit Diagram

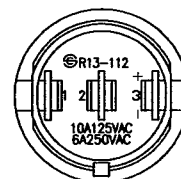
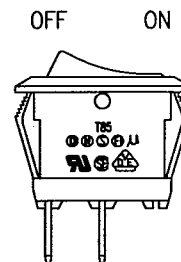
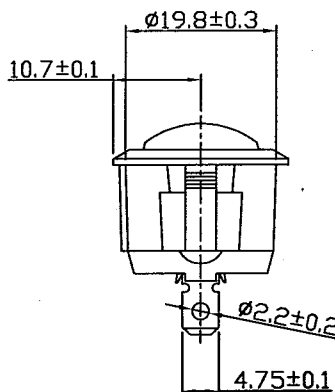
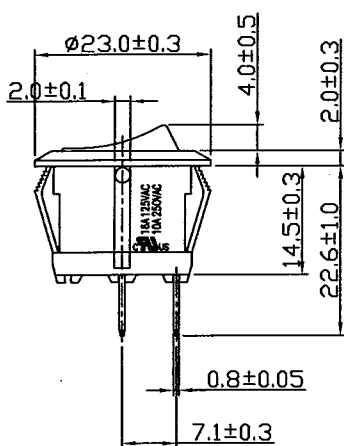
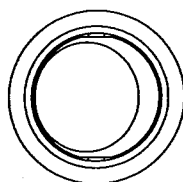
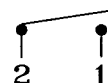

C8\R13\R13-112A5-02(1821889)

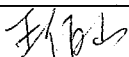
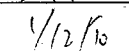
								△	
								△	
Date		Name		Description				NO	
Drawn	Checked	Approved	SCI BOM NO.	1821889	Model Name	ROCKER SWITCH			
曹盈芳			Customer No.		Model No.	R13-112A5-02	REV.		
01/12/'09			Unit	mm	SHIN CHIN INDUSTRIAL CO., LTD.				0