

Ultra-miniature, Highly Sensitive SPDT Relay for Signal Circuits

- ROHS compliant.
- Ultra-miniature at 12.5 x 7.5 x 10 mm (L x W x H).
- Wide switching power of 1 mA to 1 A.
- High sensitivity: 150mW nominal coil power.
- Fully sealed construction.
- International 2.54mm terminal pitch.
- Conforms to FCC Part 68 requirements for coil to contacts.

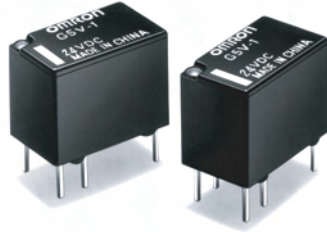

Ordering Information

Classification				Model
Contact form	Contact type	Contact material	Structure	
SPDT	Single crossbar	AG (Au Alloy)	Fully sealed	G5V-1

Note: When ordering, add the rated coil voltage to the model number.

Example: G5V-1 12 VDC

12 — Rated coil voltage

Model Number Legend

G5V - VDC

1 2

1. **Contact Form**
1: SPDT

2. **Rated Coil Voltage**
3, 5, 6, 9, 12, 24 VDC

Specifications

Coil Ratings

Rated voltage	3 VDC	5 VDC	6 VDC	9 VDC	12 VDC	24 VDC
Rated current	50 mA	30 mA	25 mA	16.7 mA	12.5 mA	6.25 mA
Coil resistance	60 Ω	167 Ω	240 Ω	540 Ω	960 Ω	3,840 Ω
Coil inductance	Armature OFF	0.05	0.15	0.20	0.45	0.85
(H) (ref. value)	Armature ON	0.11	0.29	0.41	0.93	1.63
Must operate voltage	80% max. of rated voltage					
Must release voltage	10% min. of rated voltage					
Max. voltage	200% of rated voltage at 23°C					
Power consumption	Approx. 150 mW					

Note: 1. The rated current and coil resistance are measured at a coil temperature of 23°C with a tolerance of ±10%.

2. Operating characteristics are measured at a coil temperature of 23°C.

3. The maximum voltage is the highest that can be imposed on the relay coil.

■ Contact Ratings

Load	Resistive load ($\cos\varphi = 1$)
Rated Load	0.5 A at 125 VAC; 1 A at 24 VDC
Contact Material	Ag (Au alloy)
Rated Carry Current	2 A
Max. switching voltage	125 VAC, 60 VDC
Max. switching current	1 A
Max. switching power	62.5 VA, 30 W
Failure rate (reference value)	1 mA at 5 VDC

Note: P level: $\lambda_{60} = 0.1 \times 10^{-6}$ /operation.

This value was measured at a switching frequency of 120 operations/min and the criterion of contact resistance is 100. This value may vary depending on the operating environment. Always double-check relay suitability under actual operating conditions.

■ Characteristics

Contact resistance (see note 1)	100 mΩ max.
Operate time (see note 2)	5 ms max. (mean value: approx. 2.5 ms)
Release time (see note 2)	5 ms max. (mean value: approx. 0.9 ms)
Max. operating frequency	Mechanical: 36,000 operations/hr Electrical: 1,800 operations/hr at rated load
Insulation resistance (see note 2)	1,000 MΩ min. (at 500 VDC between coil and contacts, at 250 VDC between contacts of same polarity.)
Dielectric strength	1,000 VAC, 50/60 Hz for 1 min between coil and contacts 400 VAC, 50/60 Hz for 1 min between contacts of same polarity
Impulse withstand voltage	1,500 V (10 x 160 μs) between coil and contacts (conforms to FCC Part 68)
Vibration resistance	Destruction: 10 to 55 to 10 Hz, 1.65mm single amplitude (3.3mm double amplitude) Malfunction: 10 to 55 to 10 Hz, 1.65mm single amplitude (3.3mm double amplitude)
Shock resistance	Destruction: 1,000 m/s ² Malfunction: 100 m/s ²
Endurance	Mechanical: 5,000,000 operations min. (at 18,000 operations/hr) Electrical: 100,000 operations min. (under rated load, at 1,800 operations/hr)
Ambient temperature	Operating: -40°C to 70°C (with no icing)
Ambient humidity	Operating: 5% to 85%
Weight	Approx. 2 g

Note: 1. The contact resistance was measured with 10mA at 1VDC with a voltage drop method.

2. Values in parantheses are actual values.

3. The insulation resistance was measured with a 500VDC megohmmeter between coil and contacts with a 250VDC megohmmeter between contacts with the same polarity applied to the same parts as those used for checking the dielectric strength.

■ Approved Standards

UL (File No. E41515)/CSA C22.2 No.0, No.14 (File No. LR31928)

Model	Contact form	Coil ratings	Contact ratings
G5V-1	SPDT	3 to 24 VDC	0.5 A, 125 VAC (general use) 0.3 A, 110 VDC (resistive load) 1 A, 30 VDC (resistive load)

Engineering Data

Maximum Switching Power

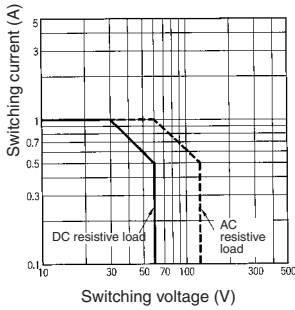

Endurance

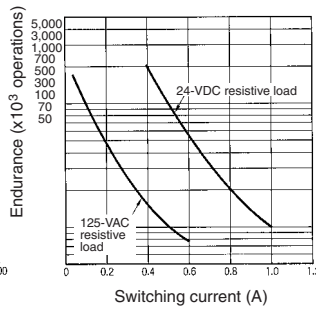

Ambient Temperature vs. Maximum Coil Voltage

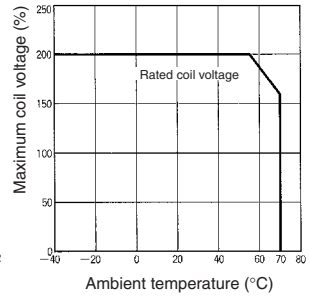

Note: The maximum coil voltage refers to the maximum value in a varying range of operating power voltage, not a continuous voltage.

Dimensions

- Note:** 1. All units are in millimetres unless otherwise indicated.
 2. Numbers in parentheses are reference values.
 3. Tolerance: ± 0.1
 4. Orientation marks are indicated as follows:

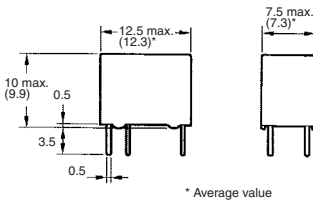
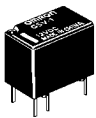

Terminal Arrangement/ Internal Connections (Bottom View)

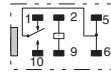

Mounting Holes (Bottom View)

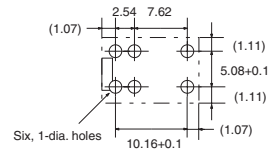

Precautions

Long-term Continuously ON Contacts

Using the Relay in a circuit where the Relay will be ON continuously for long periods (without switching) can lead to unstable contacts, because the heat generated by the coil itself will affect the insulation, causing a film to develop on the contact surfaces. Be sure to use a fail-safe circuit design that provides protection against contact failure or coil burnout.

Relay Handling

When washing the product after soldering the Relay to a PCB, use a water-based solvent or alcohol-based solvent, and keep the solvent temperature to less than 40°C. Do not put the Relay in a cold cleaning bath immediately after soldering.