

Aluminium Housed Wirewound Resistors

WH Series

Features

- High power dissipation up to 300W
- All welded construction
- Suitable for severe environments
- Designed for excellent thermal conductivity to heatsink
- Spade terminal option
- RoHS compliant

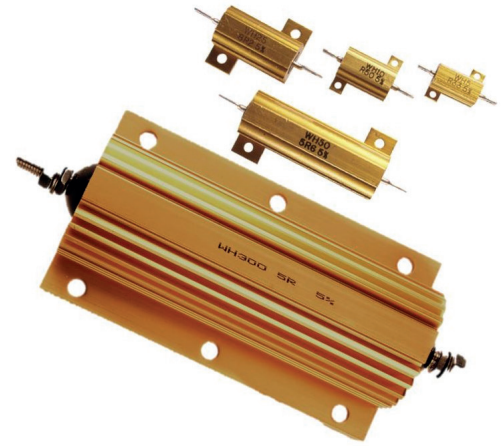

All Pb-free parts comply with EU Directive 2011/65/EU amended by (EU) 2015/863 (RoHS3)

Electrical Data

		WH5	WH10	WH25	WH50	Notes
Power rating at 25°C	watts	10	15	25 ²	50 ^{1,2}	On standard heatsink
Resistance range	ohms	OR01 to 10K	OR01 to 20K	OR01 to 44K	OR015 to 120K	
TCR (-55° to 200°C)	ppm/°C	<10R: ±75 ≥10R to <100R: ±50		≥100R: ±25		
Resistance tolerance	%	1(F), 2(G), 5(J) and 10(K)				
Low value limits	ohms	1R at 1%	OR5 at 2%	OR05 at 5%	OR01 at 10%	WH50 OR015 at 10%
Isolation voltage	volts	1500	1500	3000	3000	DC or AC peak

Note 1: For load at full rating mount on aluminium heatsink 30.5cm x 30.5cm x 1.5mm

Note 2: WH25T & WH50T are additionally rated at 15A

IECQ-CECC 40203-006 requirements*		AA	BA	CA	DA	Notes
Power rating at 25°C	watts	10	15	25	40	On standard heatsink
Resistance range	ohms	OR05 to 3K4	OR05 to 15K	OR05 to 33K	OR05 to 82K	
TCR (-55° to 200°C)	ppm/°C	≥5R to ≤10R: ± 100		>10R: ±50		
Resistance tolerance	%	1(F), 2(G), and 5(J)				
Low value limits	ohms	1R at 1%		OR5 at 2%	OR05 at 5%	
Isolation voltage	volts	1000	1000	2000	2000	DC or AC peak

* This table indicates the CECC specification requirements which are met or exceeded by the corresponding WH series products

Limiting element voltage	volts	150	250	500	1250	DC or AC rms
Standard values		E24 preferred range				Other values to order
Thermal impedance	°C/watt	16.0	10.0	6.0	3.5	On standard heatsink
Ambient temperature range	°C	-55 to 200				

		WH100	WH200	WH300	Notes	
Power rating at 25°C	watts	100	200	300	On standard heatsink	
Resistance range	ohms	OR01 to 70K	OR01 to 50K	OR01 to 68K		
TCR (-55° to 200°C)	ppm/°C	≤1K0: ±100 >1K0: ±25				
Resistance tolerance	%	Standard 5(J) and 10(K). Also available: 1(F) and 2(G)				
Low value limits	ohms	Typically ≥OR05: ±5%		≤OR047: ±10%		
Isolation voltage	volts	6360	7070	7070	DC or AC peak	
Limiting element voltage	volts	1900	1900	2500	DC or AC rms	
Standard values		E24 preferred range				Other values to order
Thermal impedance	°C/watt	1	0.7	0.6	On standard heatsink	
Ambient temperature range	°C	-55 to 200				

General Note

TT Electronics reserves the right to make changes in product specification without notice or liability.

All information is subject to TT Electronics' own data and is considered accurate at time of going to print.

WH Series

Physical Data

Dimensions (mm) & Weight (g)														
WH5, 10, 25 & 50														
Type	A Max	B ±0.3	C ±0.3	E Min	F Max	G Max	H Dia ±0.2	L Max	M ±0.5	N Max	Dt Min	Wt Nom		
WH5	30	12.4	11.3	1.9	17	9	2.4	17.0	4.3	1.8	2.5	3.6		
WH10	36.5	15.9	14.3	1.9	21	11	2.4	21.0	5.2	2.2	2.9	5.6		
WH25	51 ¹	19.8	18.3	2.8	28	15	3.3	29.0	7.2	2.6	4.3	13		
WH50	72.5 ²	21.4	39.7	2.8	30	16	3.3	51.0	7.9	2.6	5.1	29		
WH100, 200 & 300														
	A Max	B Max	C Max	D Max	E Max	F ±0.3	G ±0.3	H Max	J Max	K Max	L Nom ³	M Max	Dt Min	Wt. Nom
WH100	47.5	88	24.1	27.3	65.2	35	37	11.8	15.4	3.7	4.4	-	7.0	115
WH200	72.5	145.7	41.8	45.5	89.7	70	57.2	20.5	10.4	5.5	5.1	103.4	15	475
WH300	72.5	184.4	41.8	45.5	127.7	104	59	20.5	12.4	5.5	6.6	141.4	15	700

Note 1: A_{max} for WH25T is 71.3

Note 2: A_{max} for WH50T is 95.5

Note 3: WH100: ±0.25, WH200 & 300: ±0.45

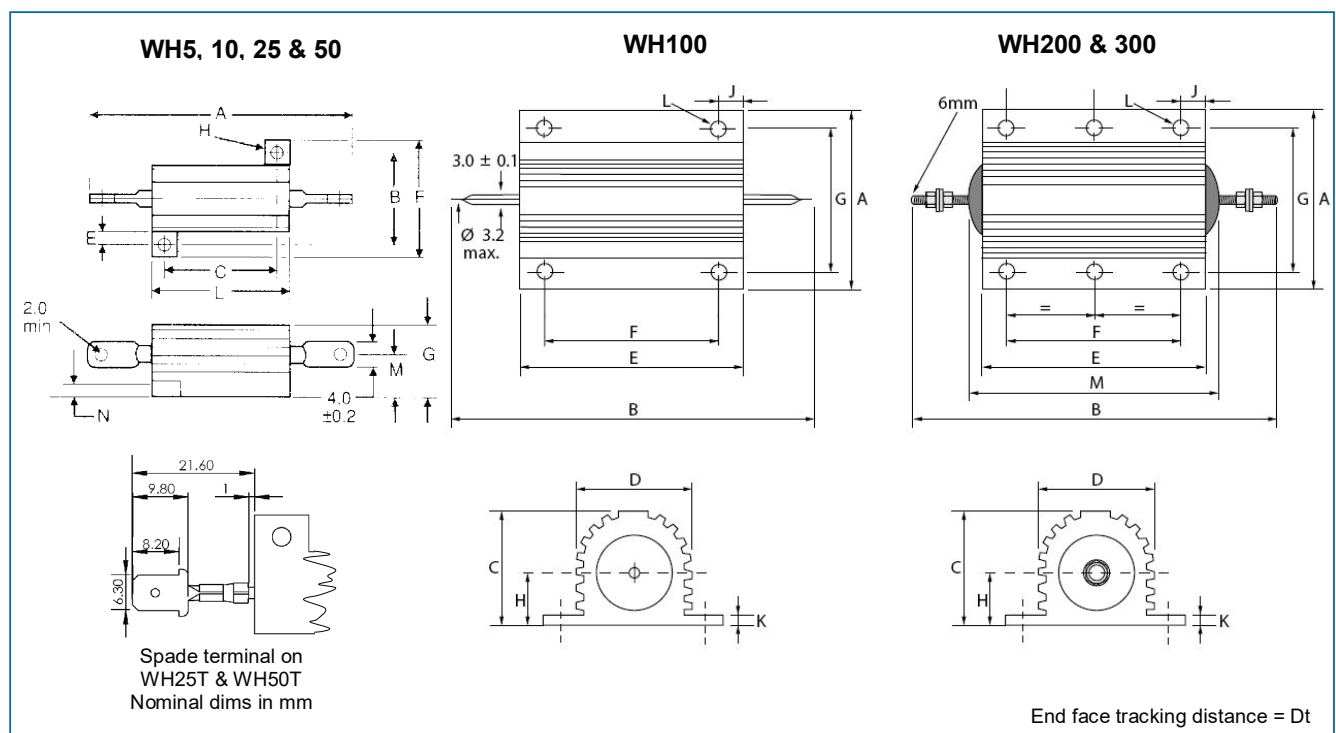

Construction

Cap and lead assemblies are fitted to a high purity ceramic substrate. The resistive element is wound onto the substrate and welded to the caps. The wound rod is then moulded and fitted into aluminium housing to give optimum stability and reliability.

Marking

The resistors are legend marked with type reference, resistance value and tolerance which will withstand all accepted industrial cleaning fluids. Values are marked in accordance with IEC 62.

WH100 and larger sizes are also marked with date code (YY.WW) and country of origin.

General Note

TT Electronics reserves the right to make changes in product specification without notice or liability. All information is subject to TT Electronics' own data and is considered accurate at time of going to print.

WH Series

Terminations

WH5-100
Material Pb-free solder dipped, copper clad steel
Strength The terminations meet the requirements of IEC 68.2.21
Solderability The terminations meet the requirements of IEC 115-1, clause 4.17.3.2

WH25T & 50T 6.35mm (¼") spade terminal

WH200 & 300
Material M6 threaded steel terminal with a set of four nuts and washers
Strength Termination robustness 50N max
 Tightening torque 5Nm max

Performance Data

	IECQ-CECC 40203-006 Requirements	WH5, 10, 25 & 50		WH100, 200 & 300
		Maximum	Actual Typical	Maximum
Load at commercial rating: 1000hrs at 25°C	ΔR% 1	1	0.4	2
Load at IECQ-CECC rating: 1000hrs at 25°C	ΔR% 1	1	0.4	N/A
Dry heat: 1000hrs at 200°C	ΔR% 1	1	0.4	2
Derating from 25°C		Zero at 200°C, see derating graph		
Short-term overload	ΔR% 1	1	0.2	
Climatic sequence	ΔR% 1	1	0.4	
Climatic category		55/200/56		
Long-term damp heat	ΔR% 1	0.5	0.2	
Temperature rapid change	ΔR% 0.25	0.25	0.1	0.25
Resistance to solder heat	ΔR% 0.25	0.25	0.05	WH100: 0.5
Vibration and bump	ΔR% 0.25	0.25	0.025	
Noise (in decade of frequency)	μV/V Not specified	0	0	0
Insulation resistance	ohms 1G min		10G min	
Pulse and overload performance	Not specified		See graphs	

Note: A 0.05 ohm addition is to be added to the performance of all resistors < 10 ohms.

Pulse and Overload Performance

For short durations of ≤0.1s the energy graph should be used. For longer durations the overload graph applies.

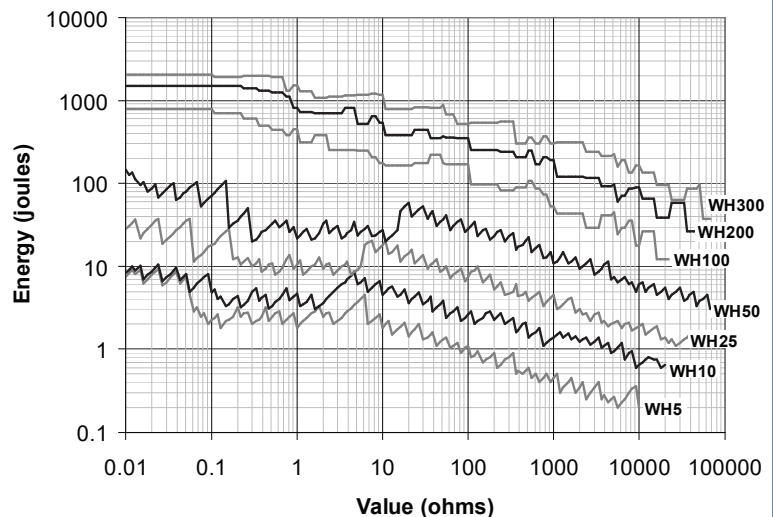
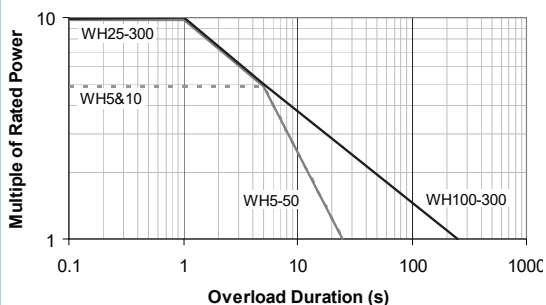

Application Notes

After soldering, care should be taken to ensure that there are no flux residues on the end faces of the moulding compound, otherwise insulation resistance will be reduced. The minimum surface tracking distances from termination to casing are shown in the Physical Data tables as dimension Dt.

It is recommended that the resistor base should be coated thinly with heatsink compound before mounting to obtain the stated operating characteristics. The heatsink compound increases thermal conductivity to the heatsink.

General Note

TT Electronics reserves the right to make changes in product specification without notice or liability. All information is subject to TT Electronics' own data and is considered accurate at time of going to print.

WH Series

The standard aluminium heatsinks are defined in the table below. If smaller heatsinks are used then derating should be applied as indicated in the graph below. If no heatsink is employed, use the ratings for 1cm².

Reference heatsink dimensions

Type (CECC)	Thickness (mm)	Area (cm ²)
WH5 (AA)	1	410
WH10 (BA)	1	410
WH25 (CA)	1	544
WH50 (DA)	1	544
WH50 @ 50W	1.5	930
WH100	3	1000
WH200	3	3800
WH300	3	5800

Derating for reduced heatsink dimensions

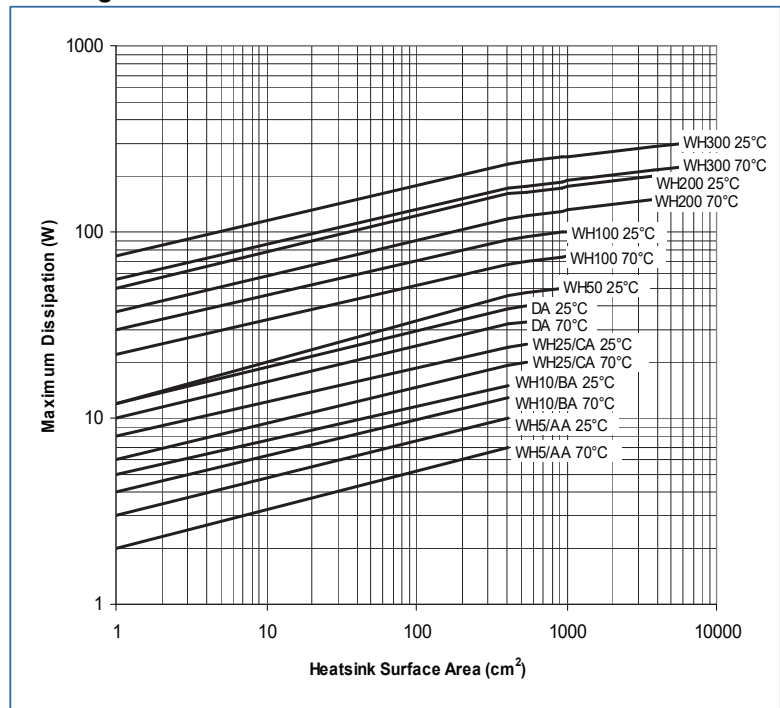

Derating for ambient temperature

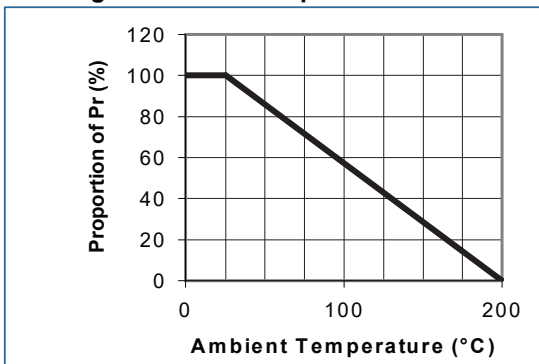

Packaging

WH resistors are packed in plastic bags and boxed.

Ordering Procedure

Example: WH25-100RJ (WH25 at 100 ohms ±5%, Pb-free)

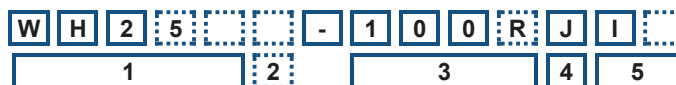

1	2		3	4	5				
Type	Termination		Value	Tolerance	Packing & Termination Finish				
WH5	T	All types	E24 = 3/4 characters R = ohms K = kilohms	F = ±1%	I	All types	Standard packing & Pb-free		
WH10		WH25, WH50		6.35mm spade terminals		G = ±2%	PB	WH5, 10, 25 & 50	Standard packing & SnPb
WH25									
WH50						J = ±5%	Bulk		250/box
WH100						K = ±10%		WH5, WH10	
WH200								WH25, WH50	
WH300				WH100		45/box			
						WH200, WH300	10/box		

For CECC released product (WH5, 10, 25 & 50 ONLY) follow the MPN with text indicating the relevant release and style. (Note that this additional text does not form part of our MPN.) Example: **WH25-3K3JI IECQ-CECC40203-006 CA**

General Note

TT Electronics reserves the right to make changes in product specification without notice or liability. All information is subject to TT Electronics' own data and is considered accurate at time of going to print.