

# 5G High-Efficiency External Whip Antenna



**AETC2303X**

Request Samples



Check Inventory



237 x 39 mm

RoHS/RoHS II Compliant

MSL = N/A

## Features

- Operates in 617-7150 MHz
- Peak Gain of 3.0 dBi
- High Efficiency
- Easy installation with built-in connector
- Customizable connector options

## Applications

- IoT
- M2M
- 5G, UWB
- 4G/LTE radios
- 2G/3G/4G radios
- Gateways & Routers
- Security / Remote Monitoring

## Product Image



# 5G High-Efficiency External Whip Antenna



**AETC2303X**

Request Samples



Check Inventory



237 x 39 mm

RoHS/RoHS II Compliant

MSL = N/A

## Part Number Builder

AETC2303X□ - □□

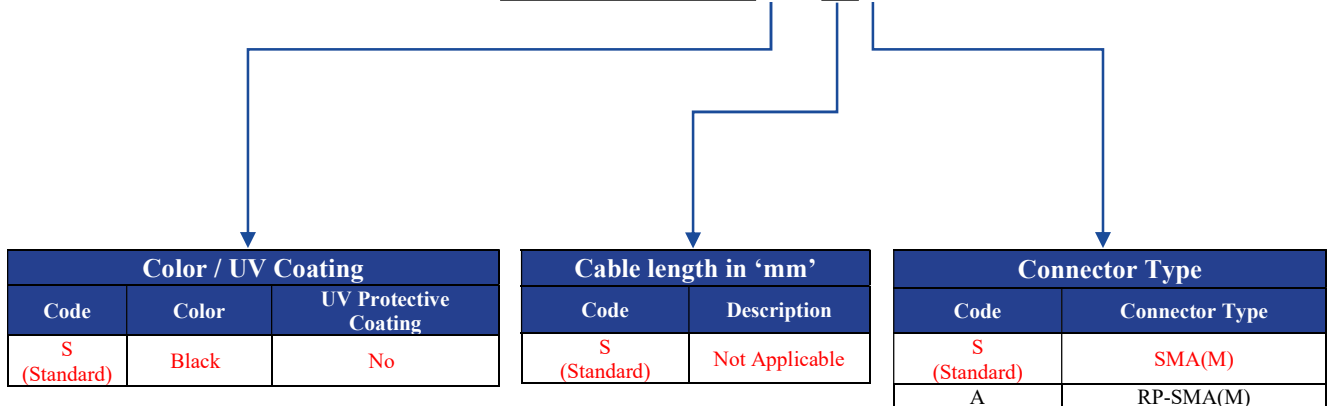

### Example Configurations:

Part Number	Color / UV Protective Coating	Cable length	Connector Type
AETC2303XS-SS	Black / No	Not Applicable	SMA(M) (Standard)
AETC2303XS-SA	Black / No	Not Applicable	RP-SMA(M)

### Note:

- For the standard part number (AETC2303XS-SS), please refer to the packaging at the end of the document.
- For custom configurations (AETC2303X□-□□), MOQs, pricing and packaging changes may apply.

# 5G High-Efficiency External Whip Antenna



**AETC2303X**

Request Samples



Check Inventory



237 x 39 mm

RoHS/RoHS II Compliant

MSL = N/A

## Electrical Specification

Parameter	Specification			Unit
	Min	Typ	Max	
Operating Frequency	617		960	MHz
	1452		1575.412	
	1710		2690	
	3300		4200	
	4400		5000	
	5150		7125	
VSWR			3.0	
Gain	(617-960 MHz)	2.0		dBi
	(1452-1575.412 MHz)	2.5		
	(1710-2690 MHz)	3.0		
	(3300-4200 MHz)	3.0		
	(4400-5000 MHz)	3.0		
	(5150-7150 MHz)	3.0		
Impedance		50		$\Omega$
Polarization		Linear		
Radiation Pattern (Azimuth)		Omni-directional		

## Mechanical Specification

Parameter	Specification
Dimensions	237 x 39 mm
Material	ABS
Color	Black
Antenna Type	Whip
RF Connector	SMA(M)
Weight	52 g

## Environmental Specification

Parameter	Specification
Operating Temperature	-40°C to +85°C
Storage Temperature	-40°C to +85°C
ROHS Complaint	Yes
MSL	N/A



5101 Hidden Creek Ln Spicewood TX 78669  
 Phone: 512-371-6159 | Fax: 512-351-8858  
 For terms and conditions of sales, please visit:  
[www.abracon.com](http://www.abracon.com)

REVISED: 12-14-22

ABRACON IS  
 ISO9001-2015  
 CERTIFIED

# 5G High-Efficiency External Whip Antenna



AETC2303X

Request Samples



Check Inventory



237 x 39 mm

RoHS/RoHS II Compliant

MSL = N/A

## Product Dimension

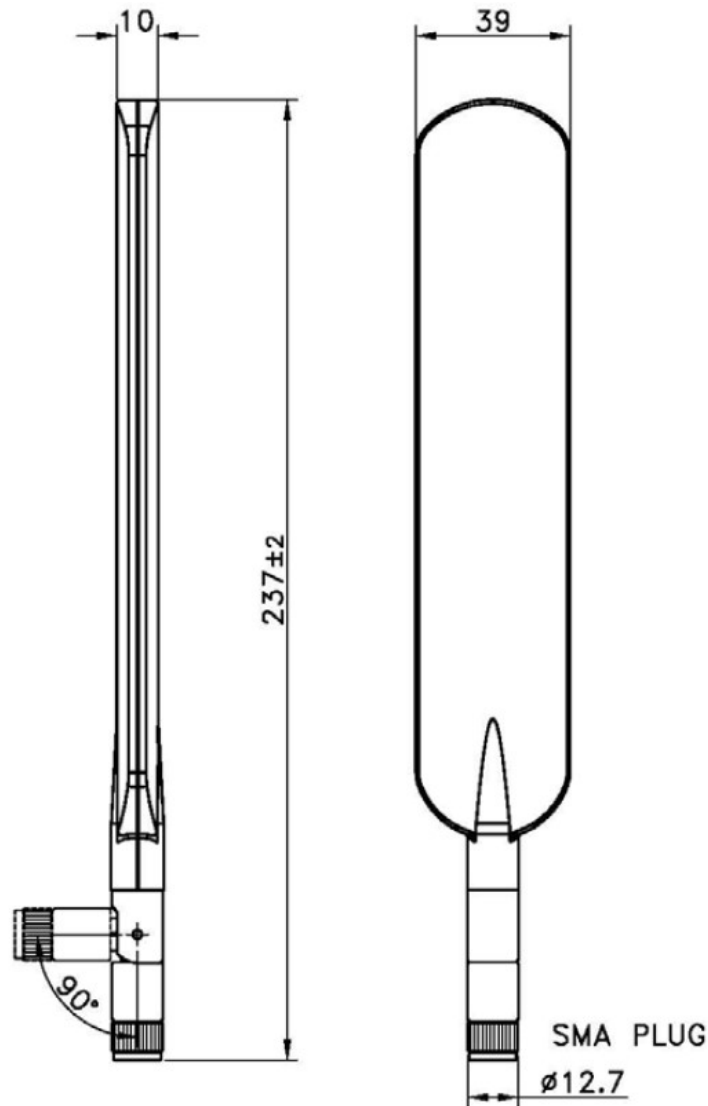

Unit : mm



5101 Hidden Creek Ln Spicewood TX 78669  
Phone: 512-371-6159 | Fax: 512-351-8858  
For terms and conditions of sales, please visit:  
[www.abracon.com](http://www.abracon.com)

REVISED: 12-14-22

ABRACON IS  
ISO9001-2015  
CERTIFIED

# 5G High-Efficiency External Whip Antenna



AETC2303X

Request Samples



Check Inventory



237 x 39 mm

RoHS/RoHS II Compliant

MSL = N/A

## Return Loss/VSWR Measurement

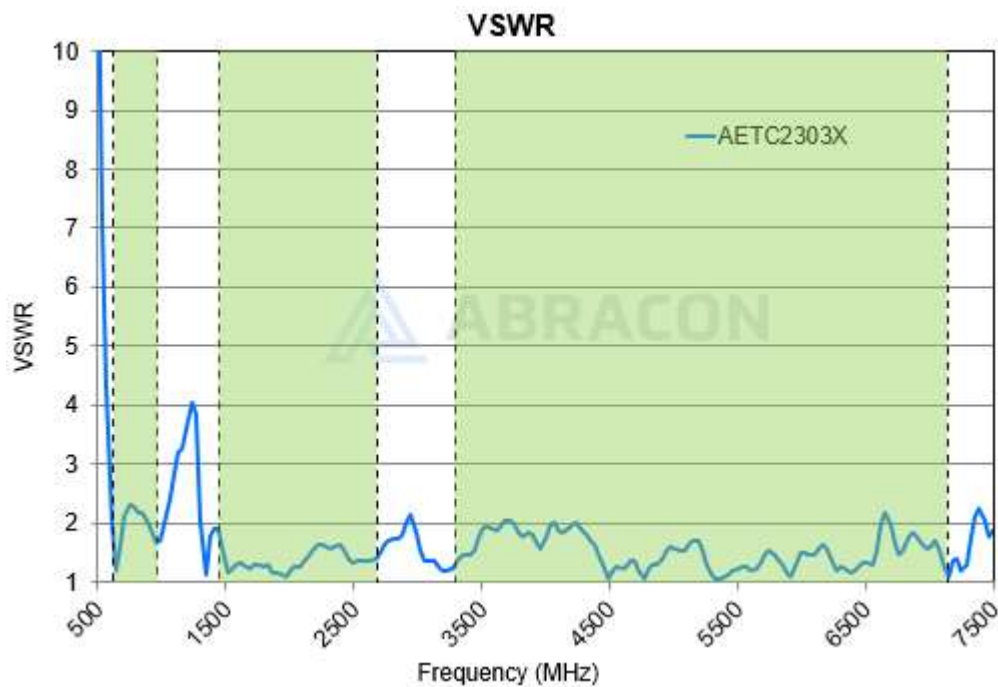
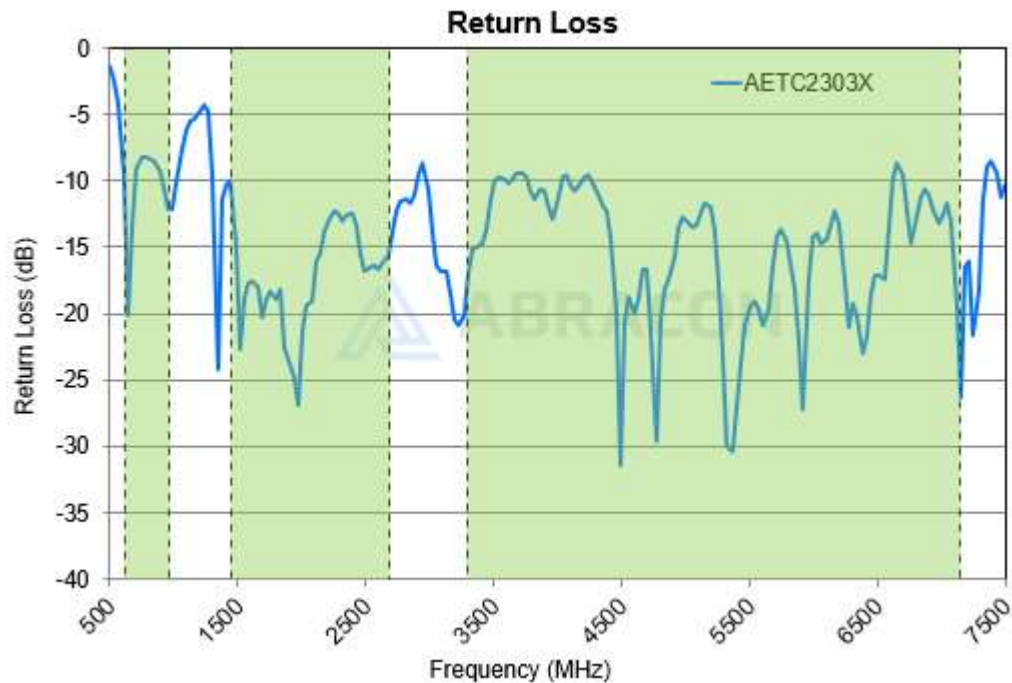

# 5G High-Efficiency External Whip Antenna



AETC2303X

Request Samples



Check Inventory



237 x 39 mm

RoHS/RoHS II Compliant

MSL = N/A

## 3D Radiation Pattern

-40dB -32dB -25dB -18dB -11dB -4dB 3dB



617 MHz

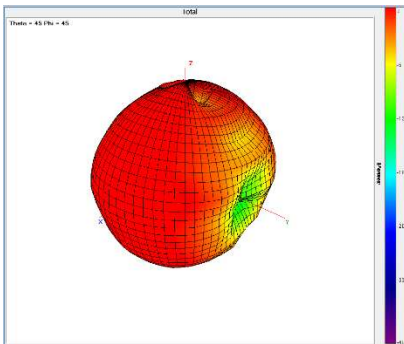

800 MHz

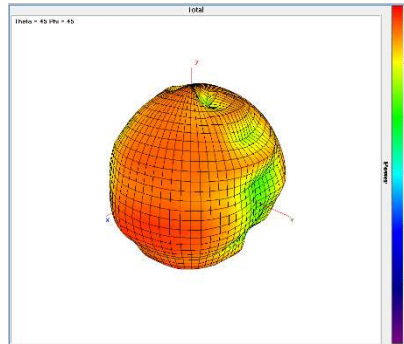

960 MHz

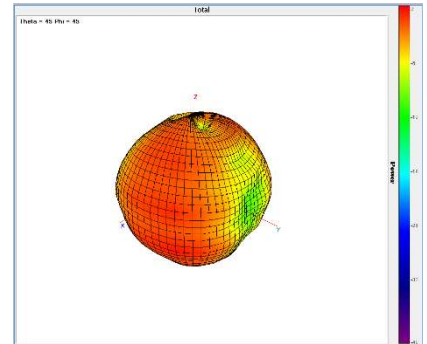

1450 MHz

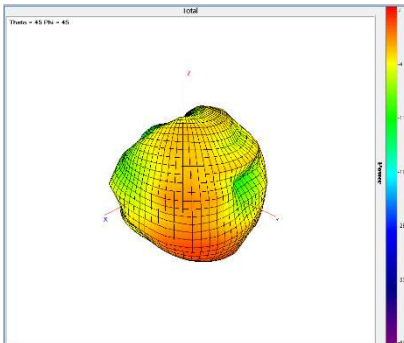

1545 MHz

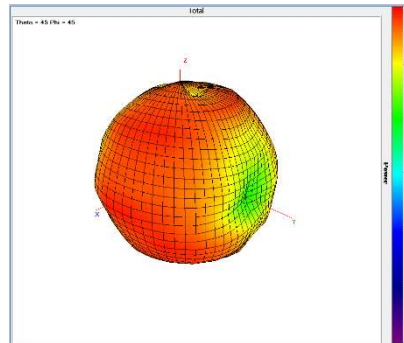

1575.142 MHz

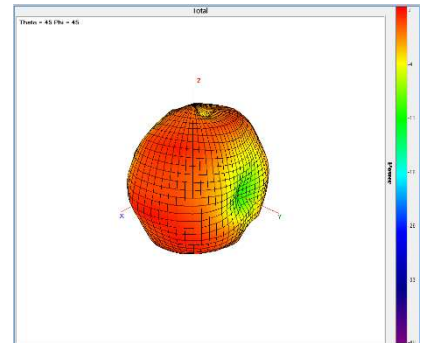

1710 MHz

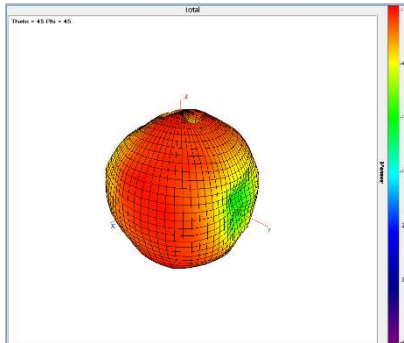

2200 MHz

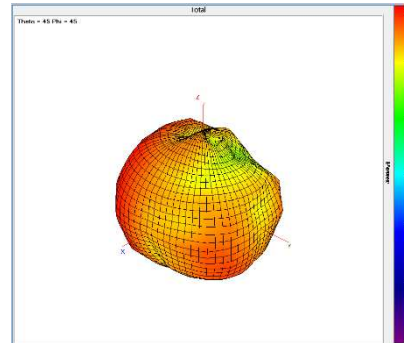

2690 MHz

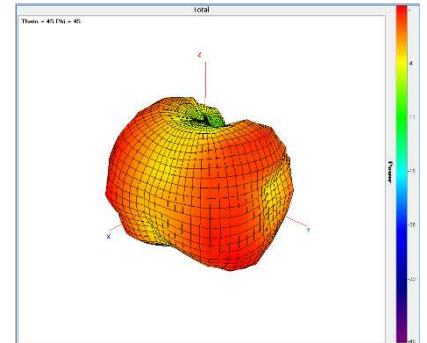

5101 Hidden Creek Ln Spicewood TX 78669  
Phone: 512-371-6159 | Fax: 512-351-8858  
For terms and conditions of sales, please visit:  
[www.abracon.com](http://www.abracon.com)

REVISED: 12-14-22

ABRACON IS  
ISO9001-2015  
CERTIFIED

# 5G High-Efficiency External Whip Antenna



AETC2303X

Request Samples



Check Inventory



237 x 39 mm

RoHS/RoHS II Compliant

MSL = N/A

3300 MHz

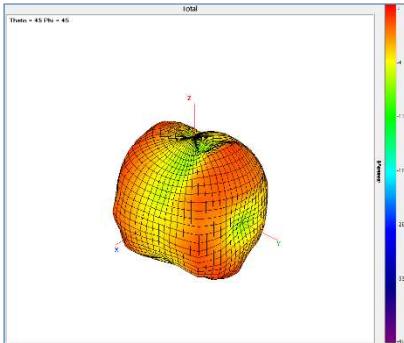

3700 MHz

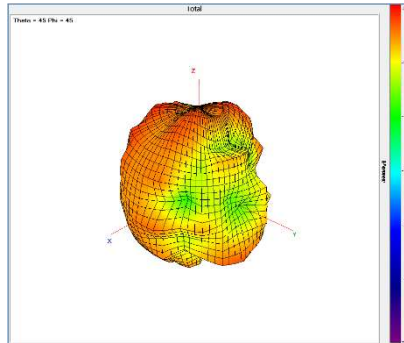

4200 MHz

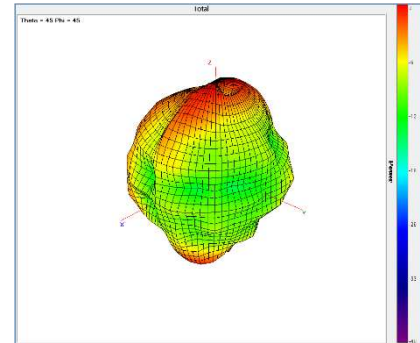

4400 MHz

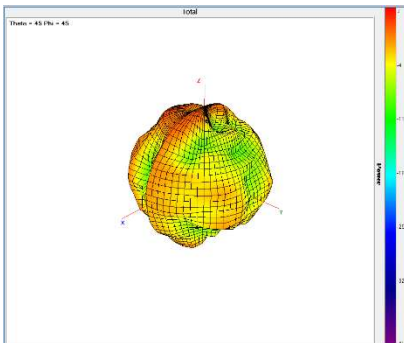

4700 MHz

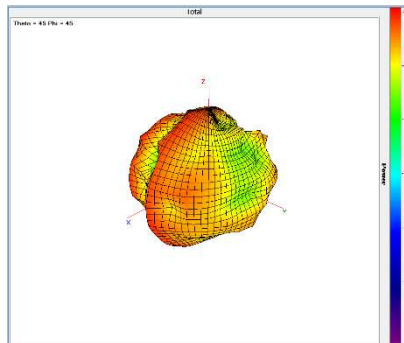

5000 MHz

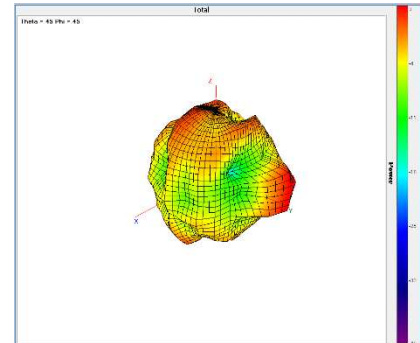

5150 MHz

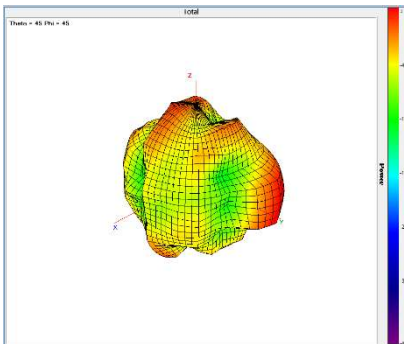

5450 MHz

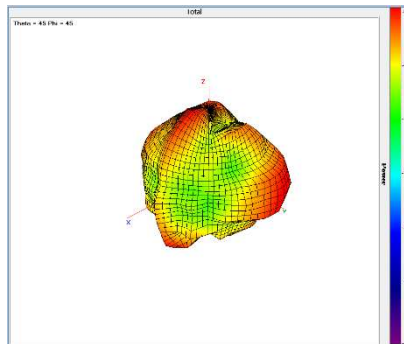

5850 MHz

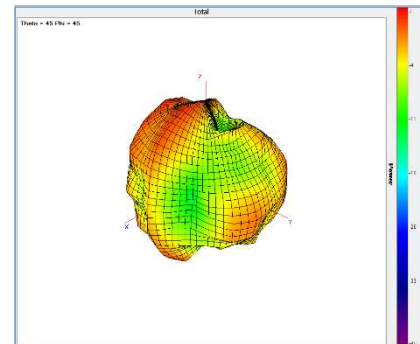



# 5G High-Efficiency External Whip Antenna



**AETC2303X**

Request Samples



Check Inventory



237 x 39 mm

RoHS/RoHS II Compliant

MSL = N/A

5950 MHz

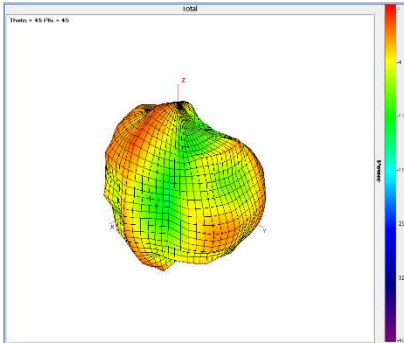

6550 MHz

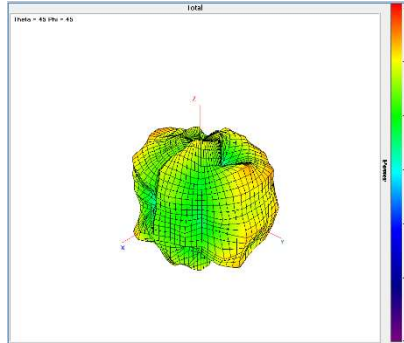

7150 MHz

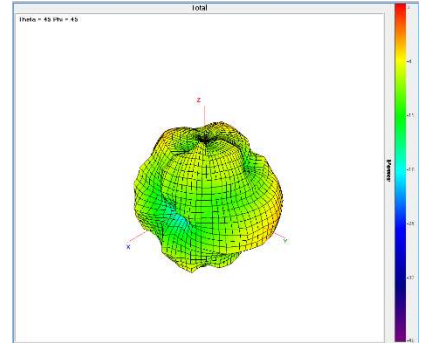



# 5G High-Efficiency External Whip Antenna



**AETC2303X**

Request Samples



Check Inventory



237 x 39 mm

RoHS/RoHS II Compliant

MSL = N/A

## Gain and Efficiency

### Gain (dB)

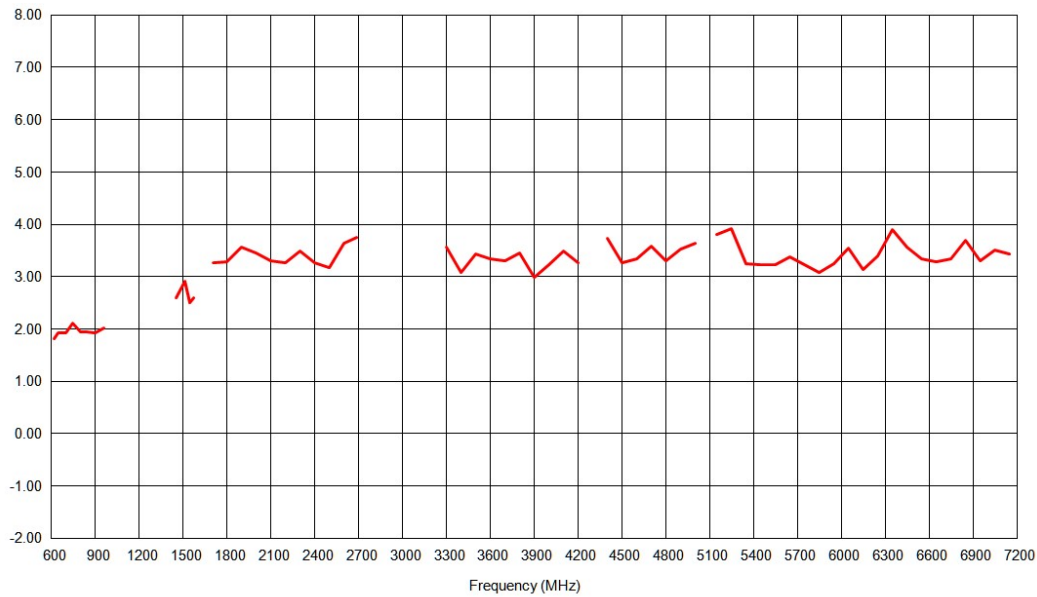

### Efficiency (%)

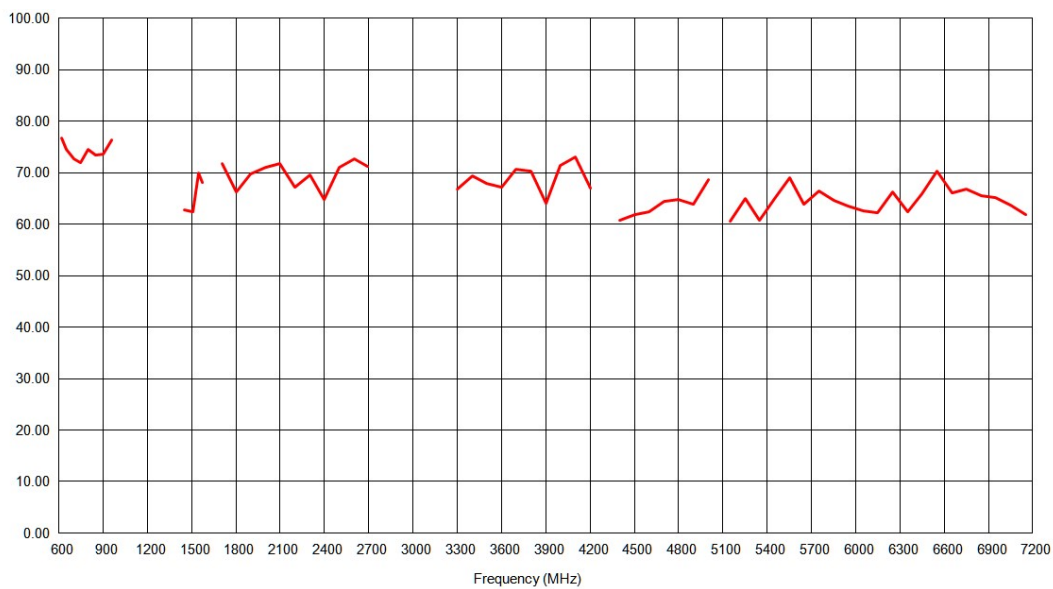

5101 Hidden Creek Ln Spicewood TX 78669  
Phone: 512-371-6159 | Fax: 512-351-8858  
For terms and conditions of sales, please visit:  
[www.abracon.com](http://www.abracon.com)

REVISED: 12-14-22

ABRACON IS  
ISO9001-2015  
CERTIFIED

# 5G High-Efficiency External Whip Antenna



**AETC2303X**

Request Samples



Check Inventory



237 x 39 mm

RoHS/RoHS II Compliant

MSL = N/A

Frequency (MHz)	617	650	700	750	800	850	900	960	1452	1511	1545	1575.412
Gain (dBi)	1.80	1.92	1.92	2.10	1.95	1.95	1.93	2.01	2.59	2.91	2.50	2.60
Efficiency (%)	76.77	74.43	72.70	71.98	74.56	73.46	73.60	76.27	62.81	62.31	69.93	68.03

Frequency (MHz)	1710	1800	1900	2000	2100	2200	2300	2400	2500	2600	2690
Gain (dBi)	3.26	3.28	3.57	3.44	3.30	3.27	3.48	3.26	3.16	3.64	3.74
Efficiency (%)	71.76	66.26	69.76	71.01	71.70	67.18	69.62	64.85	71.06	72.72	71.16

Frequency (MHz)	3300	3400	3500	3600	3700	3800	3900	4000	4100	4200
Gain (dBi)	3.57	3.08	3.44	3.35	3.29	3.45	2.98	3.23	3.49	3.27
Efficiency (%)	66.76	69.33	67.88	67.10	70.62	70.25	63.95	71.29	72.98	66.97

Frequency (MHz)	4400	4500	4600	4700	4800	4900	5000
Gain (dBi)	3.73	3.27	3.33	3.59	3.31	3.53	3.64
Efficiency (%)	60.82	61.89	62.35	64.44	64.69	63.87	68.72

Frequency (MHz)	5150	5250	5350	5450	5550	5650	5750	5850	5950	6050	6150
Gain (dBi)	3.80	3.92	3.25	3.22	3.22	3.38	3.22	3.07	3.25	3.54	3.13
Efficiency (%)	60.54	64.99	60.80	65.00	68.92	63.80	66.42	64.59	63.45	62.63	62.15

Frequency (MHz)	6250	6350	6450	6550	6650	6750	6850	6950	7050	7150
Gain (dBi)	3.40	3.90	3.56	3.34	3.29	3.33	3.69	3.30	3.50	3.44
Efficiency (%)	66.32	62.45	65.94	70.26	66.01	66.84	65.57	65.10	63.63	61.85

# 5G High-Efficiency External Whip Antenna



**AETC2303X**

Request Samples



Check Inventory



237 x 39 mm

RoHS/RoHS II Compliant

MSL = N/A

## Packaging Information

1 pcs / Small PE Bag

25 pcs / Big PE Bag

200 pcs / Carton

**ATTENTION:** Abracon LLC's products are COTS – Commercial-Off-The-Shelf products; suitable for Commercial, Industrial and, where designated, Automotive Applications. Abracon's products are not specifically designed for Military, Aviation, Aerospace, Life-dependent Medical applications or any application requiring high reliability where component failure could result in loss of life and/or property. For applications requiring high reliability and/or presenting an extreme operating environment, written consent and authorization from Abracon LLC is required. Please contact Abracon LLC for more information.



5101 Hidden Creek Ln Spicewood TX 78669  
Phone: 512-371-6159 | Fax: 512-351-8858  
For terms and conditions of sales, please visit:  
[www.abracon.com](http://www.abracon.com)

**REVISED: 12-14-22**

ABRACON IS  
ISO9001-2015  
CERTIFIED