

OY085S

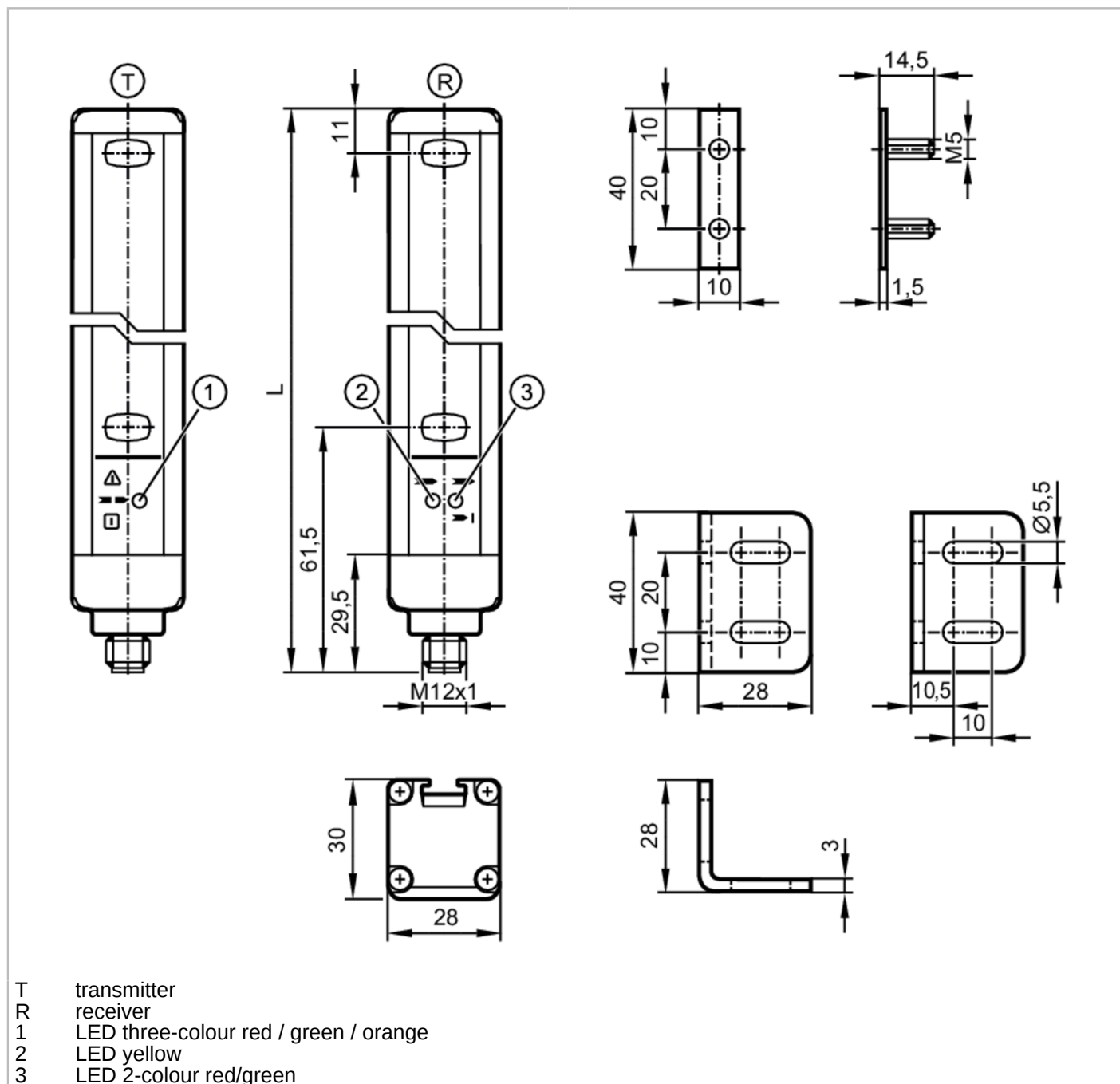

Safety light curtain

OYA0760-50-4-12-P-1



Product characteristics

Type of light	infrared light
Dimensions [mm]	813 x 28 x 30

Application

Protective function	access prevention bodies or parts of bodies
---------------------	---



Safety light curtain

OYA0760-50-4-12-P-1

Electrical data		
Operating voltage tolerance	[%]	20
Operating voltage	[V]	24 DC
Protection class		III
Reverse polarity protection		yes
Power-on delay time	[s]	< 2
Type of light		infrared light
Wave length	[nm]	950
Receiver		
Current consumption	[mA]	83
Transmitter		
Current consumption	[mA]	42
Outputs		
Electrical design		PNP
Number of OSSD outputs		2
Max. current load per OSSD output	[mA]	400; (24 V)
Short-circuit protection		yes
Detection zone		
Protected area height	[mm]	760
Resolution (detection capacity d)	[mm]	50
Protection area width (low light intensity)	[m]	0...4
Protection area width (high light intensity)	[m]	3...12
Response times		
Response time	[ms]	6.5
Operating conditions		
Applications		class C to EN 60654-1 weatherproof application
Ambient temperature	[°C]	-10...55
Storage temperature	[°C]	-20...70
Max. relative air humidity	[%]	95
Protection		IP 65; IP 67
Tests / approvals		
EMC		IEC 61496-1
Shock resistance		IEC 61496-1
Vibration resistance		IEC 61496-1



Safety light curtain

OYA0760-50-4-12-P-1

Safety classification		
ESPE type (IEC 61496-1)	4	
ISO 13849-1	category 4, PL e	
IEC 61508	SIL 3	
IEC 62061	SIL cl 3	
Mission time TM [h]	175200	
Safety-related reliability PFHD [1/h]	9.2E-09	
Mechanical data		
Weight [g]	3140	
Dimensions [mm]	813 x 28 x 30	
Materials	housing: aluminium; front lens: PC	
Length L [mm]	813	
Displays / operating elements		
Display	transmitter	1 x LED
	receiver	2 x LED
Accessories		
Accessories (supplied)	mounting bracket: 4	
	slot nuts: 4	
	Nuts	
Remarks		
Notes	For 8-pole sockets the core colours are not standardised.; Please note the wiring of the sensor and the sockets (see data sheet).	
Pack quantity	1 pcs.	
Electrical connection - receiver		
Connector: 1 x M12; Maximum cable length: 100 m; for wire cross-section 0.34 mm ²		

OY085S



Safety light curtain

OYA0760-50-4-12-P-1

Connection



Electrical connection - transmitter

Connector: 1 x M12

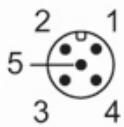

OY085S



Safety light curtain

OYA0760-50-4-12-P-1

Connection

