

San Ace 136RF

9RFA type

Reversible Flow Fan

Features

High Airflow and High Static Pressure

This fan delivers a maximum airflow of 2.10 m³/min and a maximum static pressure of 285 Pa.⁽¹⁾ Compared to our current model,⁽²⁾ the maximum static pressure has increased by approximately 2.8 times.

Fewer Fans Required

The fan's speed and blowing direction can be freely controlled by a PWM signal. By replacing multiple conventional fans with a single unit, this fan can contribute to cost reduction and space saving. Moreover, noise reduction or high efficiency can also be achieved by appropriately controlling fan speed.

Same Level of Blowing Performance in Either Direction

Almost equivalent airflow and static pressure performance can be obtained in either blowing direction. This eliminates the need to take the performance difference between two blowing directions into account in designing systems.

(1) The values are for models 9RFA1312P3G001 and 9RFA1324P3G001 when blowing in the forward direction.

(2) Current model: \varnothing 136 x 28 mm San Ace 136RF 9RF type Reversible Flow Fan (model: 9RF1312P3H001)



\varnothing 136 x 28 mm

Specifications

The models listed below have pulse sensors with PWM control function.

Model no.	Airflow direction	Rated voltage [V]	Operating voltage range [V]	PWM duty cycle* [%]	Rated current [A]	Rated input [W]	Rated speed [min ⁻¹]	Max. airflow [m ³ /min] [CFM]	Max. static pressure [Pa] [inchH ₂ O]	SPL [dB(A)]	Operating temperature [°C]	Expected life [h]
9RFA1312P3G001	Forward	12	10.2 to 13.8	100	0.25	3.00	5450	2.10	74.2	285	1.14	49
	Reverse			0				2.05	72.4	280	1.12	52
9RFA1312P3H001	Forward			100	0.16	1.92	4350	1.67	59.2	185	0.74	44
	Reverse			0				1.63	57.8	180	0.72	47
9RFA1324P3G001	Forward	24	20.4 to 27.6	100	0.13	3.12	5450	2.10	74.2	285	1.14	49
	Reverse			0				2.05	72.4	280	1.12	52
9RFA1324P3H001	Forward			100	0.08	1.92	4350	1.67	59.2	185	0.74	44
	Reverse			0				1.63	57.8	180	0.72	47

* PWM input frequency is 25 kHz.

Common Specifications

- Material Frame: Plastic (Flammability: UL 94V-0), Impeller: Plastic (Flammability: UL 94V-0)
- Expected life Refer to specifications
(L10 life: 90% survival rate for continuous operation in free air at 60°C, rated voltage)
Expected life at 40°C is for reference only.
- Motor protection function Locked rotor burnout protection, Reverse polarity protection
- Dielectric strength 50/60 Hz, 500 VAC, for 1 minute (between lead wire conductors and frame)
- Insulation resistance 10 M Ω or more with a 500 VDC megger (between lead wire conductors and frame)
- Sound pressure level (SPL) At 1 m away from the air inlet
- Operating temperature Refer to specifications (Non-condensing)
- Storage temperature -30 to +70°C (Non-condensing)
- Lead wire \oplus Red \ominus Black (Sensor) Yellow (Control) Brown
- Mass 204 g

Airflow - Static Pressure Characteristics

Operating voltage range

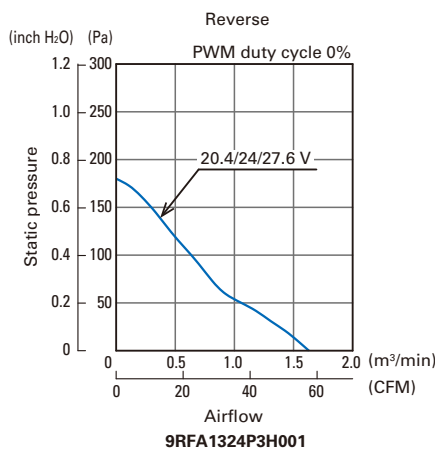
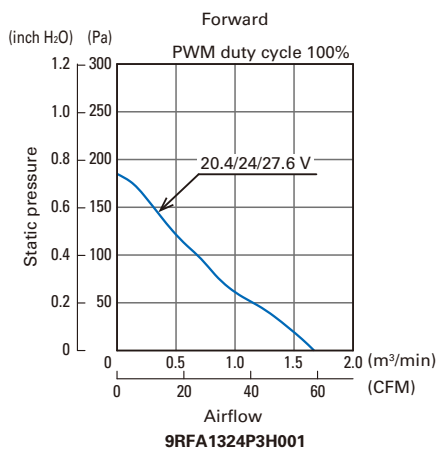
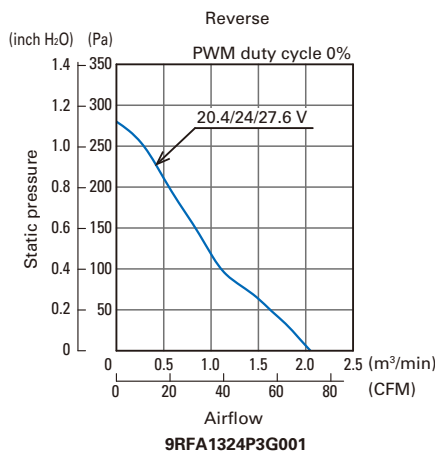
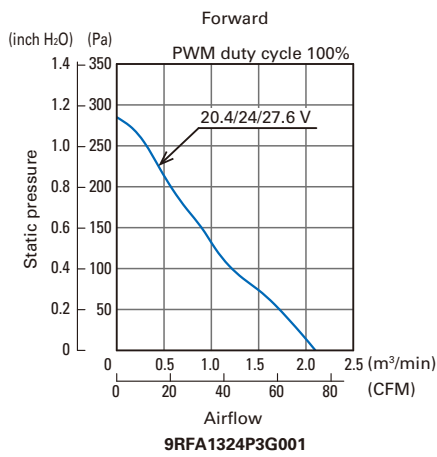
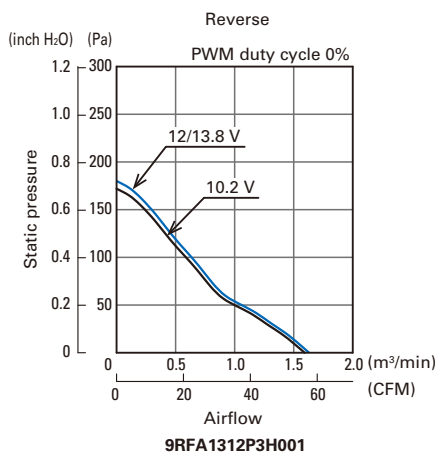
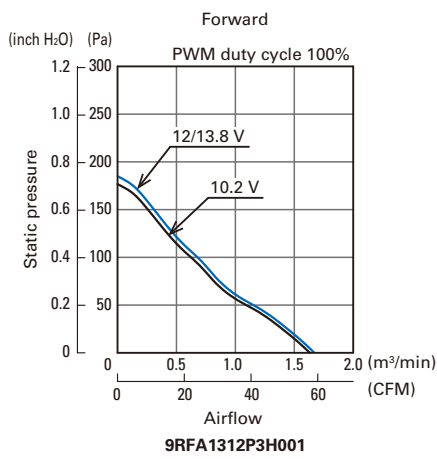
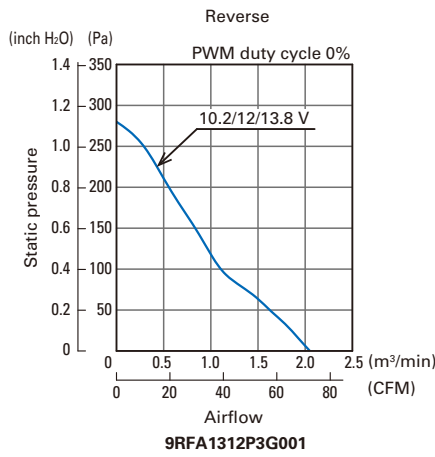
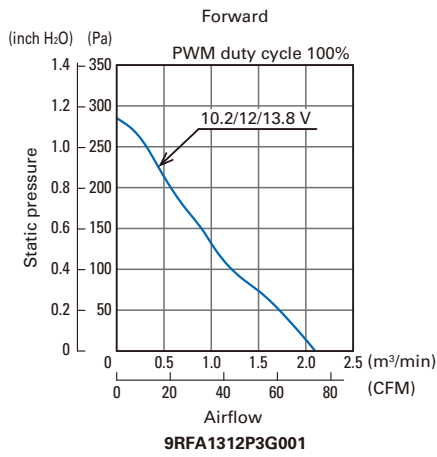

PWM Duty - Speed Characteristics Example

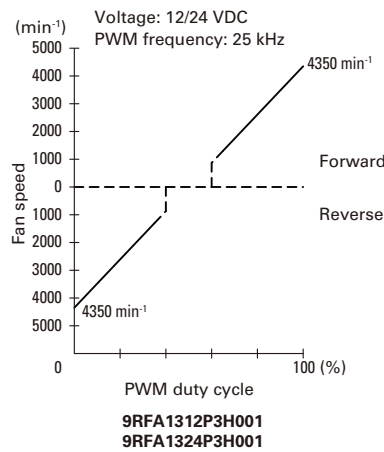
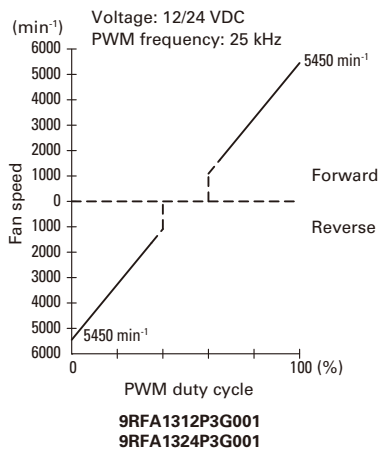

PWM Input Signal Example

Input signal waveform

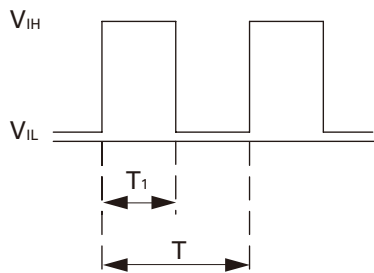

$V_{IH} = 4.75 \text{ to } 5.25 \text{ V}$ $V_{IL} = 0 \text{ to } 0.4 \text{ V}$
 $\text{PWM duty cycle (\%)} = \frac{T_1}{T} \times 100$ $\text{PWM frequency } 25 \text{ (kHz)} = \frac{1}{T}$
 Current source (I_{source}) = 1.0 mA max. (when control voltage is 0 V)
 Current sink (I_{sink}) = 1.0 mA max. (when control voltage is 5.25 V)

When the PWM control terminal is open,
 the fan speed is the same as the speed at 100% PWM duty cycle.
 Either a TTL input or open collector/drain input can be used for the PWM input signal.

Example of Connection Schematic

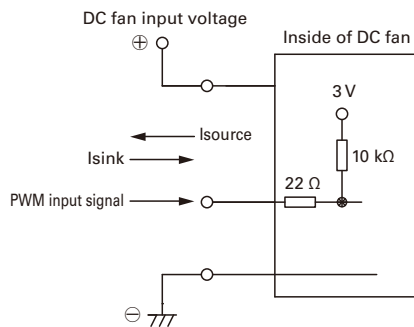

Specifications for Pulse Sensors

Output circuit: Open collector

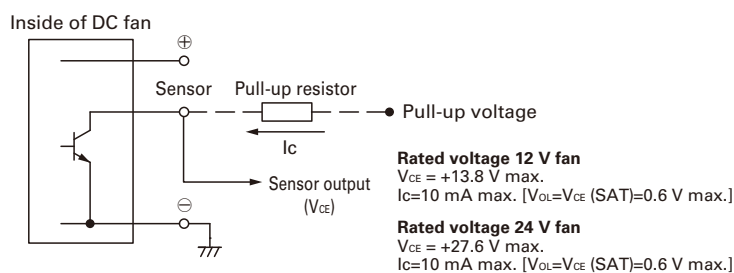

Output waveform (Need pull-up resistor)

In case of steady running

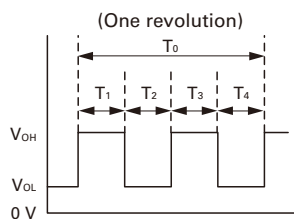

$T_{1 \text{ to } 4} \approx (1/4) T_0$
 $T_{1 \text{ to } 4} \approx (1/4) T_0 = 60/4N \text{ (s)}$
 $N = \text{Fan speed (min}^{-1}\text{)}$

■ Dimensions (unit: mm)

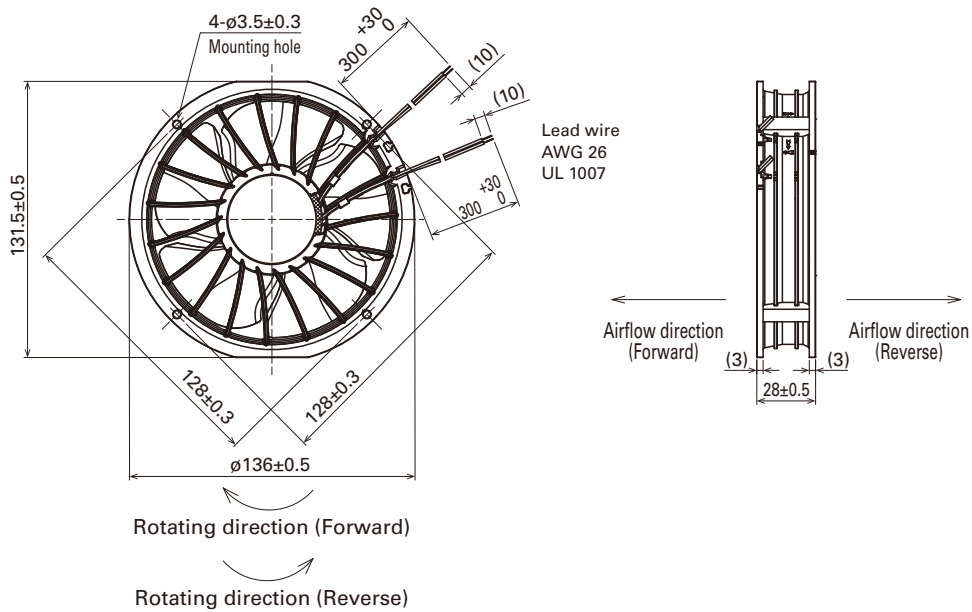

■ Reference Dimensions of Mounting Holes and Vent Opening (unit: mm)

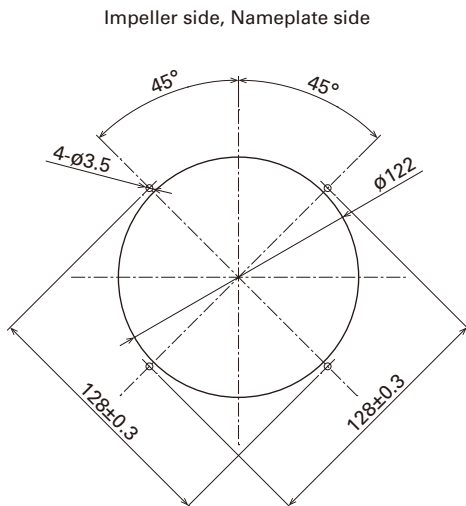

Notice

- Please read the "Safety Precautions" on our website before using the product.
- The products shown in this catalog are subject to Japanese Export Control Law. Diversion contrary to the law of exporting country is prohibited.
- For protecting fan bearings against electrolytic corrosion near strong electromagnetic noise sources, we provide effective countermeasures such as Electrolytic Corrosion Proof Fans and EMC guards. Contact us for details.

SANYO DENKI CO., LTD. 3-33-1 Minami-Otsuka, Toshima-ku, Tokyo 170-8451, Japan TEL: +81 3 5927 1020

<https://www.sanyodenki.com/>

The names of companies and/or their products specified in this catalog are the trade names, and/or trademarks and/or registered trademarks of such respective companies.

"San Ace" is a trademark of SANYO DENKI CO., LTD.

Specifications are subject to change without notice.

CATALOG No. C1125B001 '21.8