

TITLE: Grove - Piezo Vibration Sensor v1.1		
Design:		Check:
Date: 5/8/15 09:43	Vision:	Sheet: 1/2

CC-BY-SA

LDT with Crimps Vibration Sensor/Switch

- Piezo Film Sensors
- High Sensativity
- AC Coupled
- Laminated
- Robust

The **LDT0-028K** is a flexible component comprising a 28 μm thick piezoelectric PVDF polymer film with screen-printed Ag-ink electrodes, laminated to a 0.125 mm polyester substrate, and fitted with two crimped contacts. As the piezo film is displaced from the mechanical neutral axis, bending creates very high strain within the piezopolymer and therefore high voltages are generated. When the assembly is deflected by direct contact, the device acts as a flexible "switch", and the generated output is sufficient to trigger MOSFET or CMOS stages directly. If the assembly is supported by its contacts and left to vibrate "in free space" (with the inertia of the clamped/free beam creating bending stress), the device will behave as an accelerometer or vibration sensor. Adding mass, or altering the free length of the element by clamping, can change the resonant frequency and sensitivity of the sensor to suit specific applications. Multi-axis response can be achieved by positioning the mass off center. The LDTM-028K is a vibration sensor where the sensing element comprises a cantilever beam loaded by an additional mass to offer high sensitivity at low frequencies.

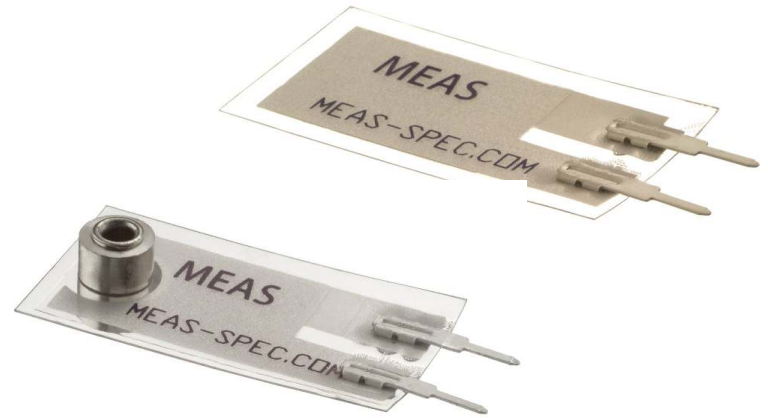

dimensions

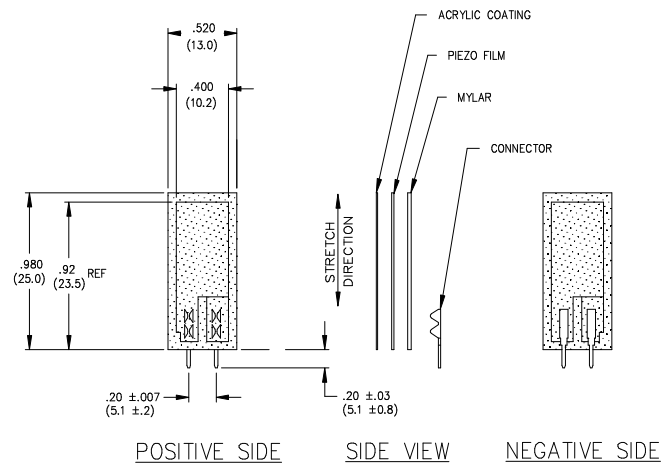

FEATURES

- Solder Tab Connection
- Both No Mass & With Mass Version
- Withstands High Impact
- Operating Temperature: 0°C to 85°C
- Storage Temperature: -40°C to 85 °C
- Higher Temperature Version up to 125 °C available on a Custom Basis

APPLICATIONS

- Vibration Sensing in Washing Machine
- Low Power Wakeup Switch
- Low Cost Vibration Sensing
- Car Alarms
- Body Movement
- Security Systems

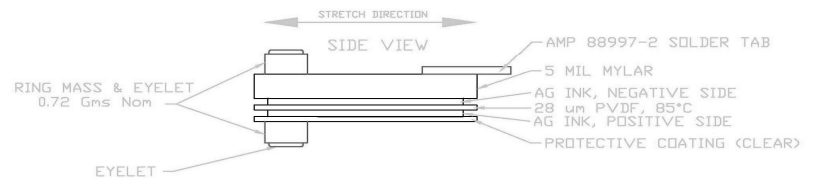
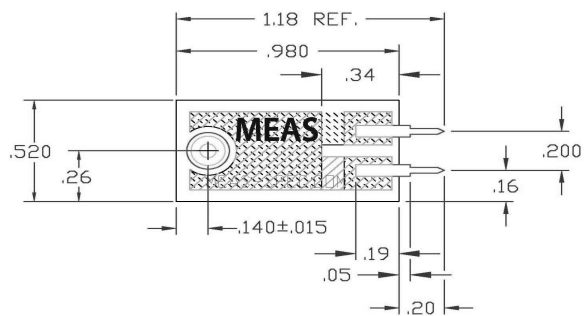

LDT with Crimps Vibration Sensor/Switch

examples of properties

Four different experiments serve to illustrate the various properties of this simple but versatile component.

Experiment #1

LDT0 as Vibration Sensor - with the crimped contacts pushed through a printed-circuit board, the LDT0 was soldered carefully in place to anchor the sensor. A charge amplifier was used to detect the output signal as vibration from a shaker table was applied (using a charge amplifier allows a very long measurement time constant and thus allows the "open-circuit" voltage response to be calculated). Small masses (approximately 0.26g increments) were then added to the tip of the sensor, and the measurement repeated. Results are shown in Table 1 and the overlaid plots in Fig. 1. Without adding mass, the LDT0 shows a resonance around 180 Hz. Adding mass to the tip reduces the resonance frequency and increases "baseline" sensitivity.

LDT0 Sensitivity: Effect of Added Mass
(Figure 1)

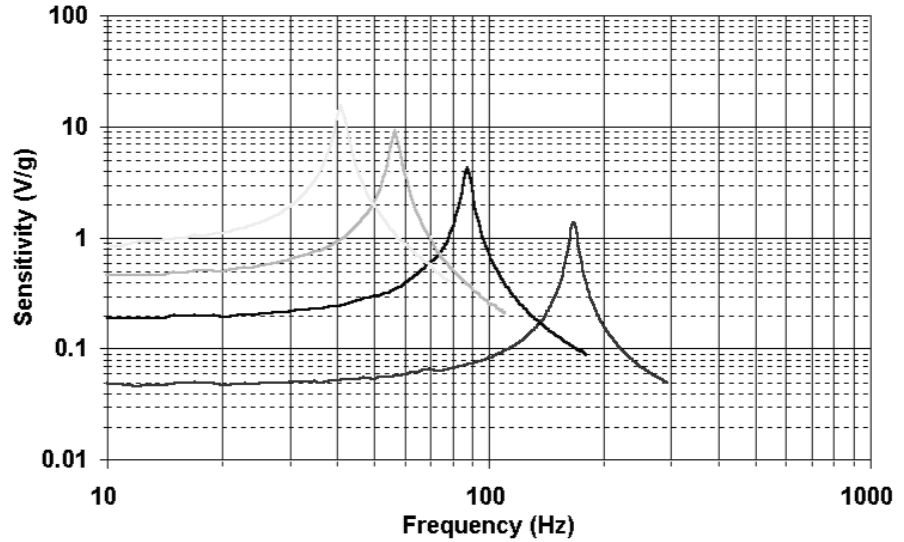

TABLE 1: LDT0 as Vibration Sensor (see Fig 1)

Added Mass	Baseline Sensitivity	Sensitivity at Resonance	Resonant Frequency	+3 Db Frequency
0	50 mV/g	1.4 V/g	180 Hz	90 Hz
1	200 mV/g	4 V/g	90 Hz	45 Hz
2	400 mV/g	8 V/g	60 Hz	30 Hz
3	800 mV/g	16 V/g	40 Hz	20 Hz

Experiment #2

LDT0 as Flexible Switch - using a charge amplifier to obtain "open-circuit" voltage sensitivity, the output was measured for controlled tip deflections applied to the sensor (supported by its crimped contacts as described above). 2 mm deflection was sufficient to generate about 7 V. Voltages above 70V could be generated by bending the tip of the sensor through 90° (see Table 2, Fig. 2).

LDT0: Voltage Output vs Tip deflection
(Figure 2)

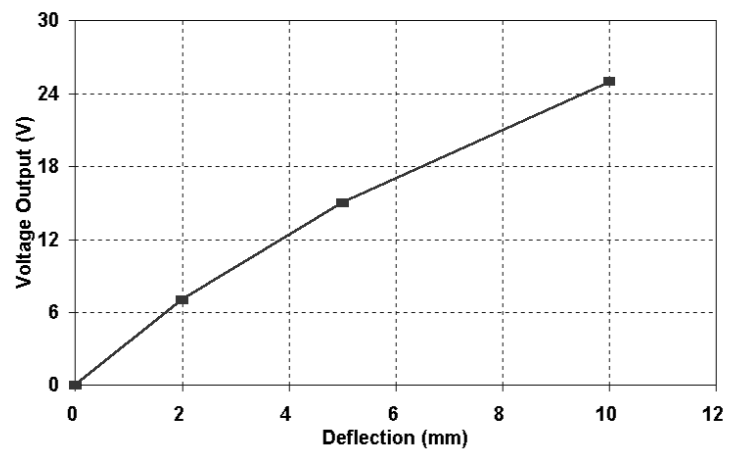

LDT with Crimps Vibration Sensor/Switch

examples of Properties (continued)

TABLE 2: LDT0 as Flexible Switch (see Fig 2)

Tip Deflection	Charge Output	o/c Voltage Output
2 mm	3.4 nC	7 V
5 mm	7.2 nC	15 V
10 mm	10 - 12 nC	20 - 25 V
max (90E)	> 30 nC	> 70 V

Experiment #3

LDT0 Electrical Frequency Response -

when the source capacitance of around 480 pF is connected to a resistive input load, a high-pass filter characteristic results. Using an electronic noise source to generate broad-band signals, the effect of various load resistances was measured and the -3 dB point of the R-C filter determined (see Table 3, Fig. 3).

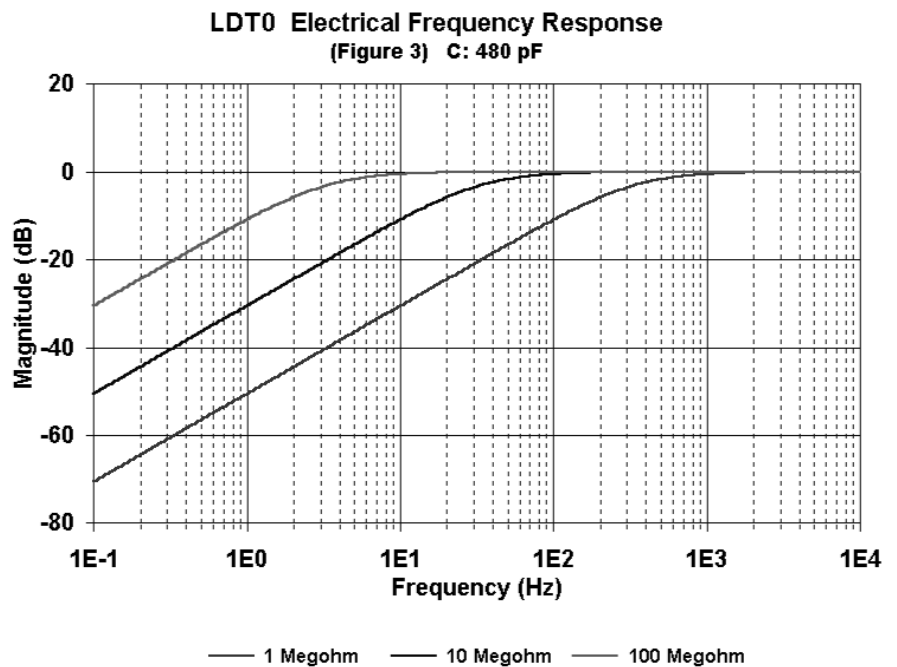

TABLE 3: LDT0 Electrical Frequency Response
(see Fig 3)
(480 pF source capacitance)

Load Resistance	-3 db Frequency
1 Megohm	330 Hz
10 Megohm	33 Hz
100 Megohm	3.3 Hz

LDT with Crimps Vibration Sensor/Switch

Experiment #4

LDT0 Clamped at Different Lengths -

using simple clamping fixture, the vibration sensitivity was measured (as in (1) above) as the clamp was moved to allow different "free" lengths to vibrate. The sensor may be "tuned" to suit specific frequency response requirements (see Table 4, Fig. 4).

LDT0: Resonant Freq vs Clamped Length
(Figure 4)

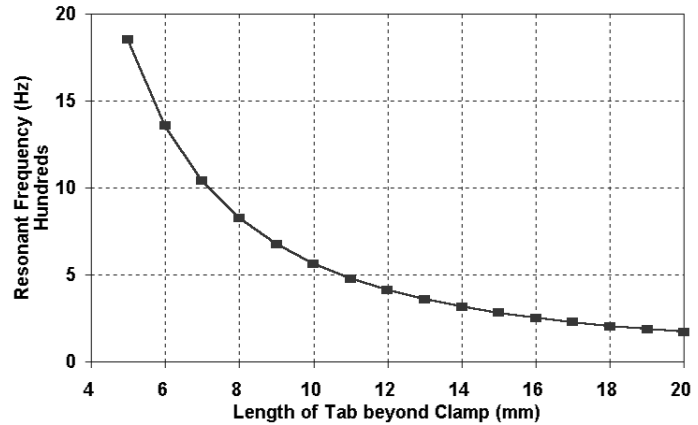

TABLE 4: LDT0 Clamped at Different Lengths (See Fig. 4)

Length Beyond Clamp	Resonant Frequency	Settling Time (5 cyc)
20 mm (no clamp)	180 Hz	28 msec
16 mm	250 Hz	20 msec
11 mm	500 Hz	10 msec
7 mm	1000 Hz	5 msec

The information in this sheet has been carefully reviewed and is believed to be accurate; however, no responsibility is assumed for inaccuracies. Furthermore, this information does not convey to the purchaser of such devices any license under the patent rights to the manufacturer. Measurement Specialties, Inc. reserves the right to make changes without further notice to any product herein. Measurement Specialties, Inc. makes no warranty, representation or guarantee regarding the suitability of its product for any particular purpose, nor does Measurement Specialties, Inc. assume any liability arising out of the application or use of any product or circuit and specifically disclaims any and all liability, including without limitation consequential or incidental damages. Typical parameters can and do vary in different applications. All operating parameters must be validated for each customer application by customer's technical experts. Measurement Specialties, Inc. does not convey any license under its patent rights nor the rights of others.

ordering information

Description	Part Number
LDT0-028K	1002794-0
LDTM-028K	1005447-1

North America

Measurement Specialties, Inc.
1000 Lucas Way
Hampton, VA 23666
Sales and Customer Service
Tel: +1-800-745-8008 or
+1-757-766-1500
Fax: +1-757-766-4297
Technical Support
Email: piezo@meas-spec.com

Europe

MEAS Deutschland GmbH
Hauert 13
44227 Dortmund
Germany
Sales and Customer Service
Tel: +49 (0)231 9740 21
Technical Support
Tel: +49 (0)6074 862822
Email: piezoeurope@meas-spec.com

Asia

Measurement Specialties (China), Ltd.
No. 26 Langshan Road
Shenzhen High-Tech Park (North)
Nanshan District
Shenzhen, China 518107
Sales and Customer Service
Tel: +86 755 3330 5088
Technical Support
Email: piezo@meas-spec.com