

SIRIUS ACT: terminal module (command and LED module), integrated LED blue, for front plate mounting



Figure similar

Product brand name	SIRIUS ACT
Product designation	Terminal module
Product type designation	3SU1

Display

Display version	
<ul style="list-style-type: none"> for diagnostic function: Supply voltage monitoring Power LED 	Yes
<ul style="list-style-type: none"> status Tx/Rx link 	No

General technical data

Product function	
<ul style="list-style-type: none"> Reverse polarity protection 	Yes; Ribbon cable can be rotated 180°.
<ul style="list-style-type: none"> Diagnostics function 	Yes
Firmware version	1.0.0
Hardware version	1
Software version with STEP 7 in the TIA Portal required	V13 SP1 (V13 SP1 and V14 with HSP0132)
Power loss [W] typical	0.115 W

Degree of pollution	3
Type of voltage	
• of the operating voltage	DC
• of the input voltage	DC
Surge voltage resistance rated value	0.8 kV
Consumed current	
• maximum	27 mA
• Rated value	23 mA
Protection class IP	IP20
Equipment marking acc. to DIN EN 81346-2	K

Communication/ Protocol

Protocol is supported	
• PROFI-safe protocol	No

Connections/Terminals

Type of electrical connection	Insulation displacement connection
Type of connectable conductor cross-sections	Ribbon cable 7-pole, 7 x 0.08 mm ²
Connectable conductor cross-section for auxiliary contacts	
• single or multi-stranded	0.08 ... 0.08 mm ²
• finely stranded with core end processing	0.08 mm ²
Connectable conductor cross-section	
• solid	0.08 ... 0.08 mm ²
• solid with core end processing	0.08 ... 0.08 mm ²
• finely stranded with core end processing	0.08 ... 0.08 mm ²
• finely stranded without core end processing	0.08 ... 0.08 mm ²
AWG number as coded connectable conductor cross section	28 ... 28

Lamp

Color of the light source	blue
----------------------------------	------

Safety related data

Service life maximum	20 y
-----------------------------	------



Ambient conditions

Ambient temperature	
• during operation	-25 ... +60 °C
• during storage	-40 ... +80 °C
Environmental category during operation acc. to IEC 60721	3M6, 3S2, 3B2, 3K6 (with relative air humidity of 10 ... 95 %, no condensation in operation permitted)
Explosion protection marking for intrinsic safety of related equipment EEx ia	No
Explosion protection marking for intrinsic safety of related equipment EEx ib	No

Installation/ mounting/ dimensions

Mounting type of modules and accessories	Snap-on mounting
Height	32.6 mm
Width	30 mm
Depth	31.5 mm

Certificates/approvals

General Product Approval	Declaration of Conformity	Test Certificates	other
 UL		 EG-Konf.	Declaration of the Compliance with the order Special Test Certificate Confirmation

Further information

Information- and Downloadcenter (Catalogs, Brochures,...)

<http://www.siemens.com/industrial-controls/catalogs>

Industry Mall (Online ordering system)

<https://mall.industry.siemens.com/mall/en/en/Catalog/product?mlfb=3SU1401-1MC50-1CA1>

Cax online generator

<http://support.automation.siemens.com/WW/CAXorder/default.aspx?lang=en&mlfb=3SU1401-1MC50-1CA1>

Service&Support (Manuals, Certificates, Characteristics, FAQs,...)

<https://support.industry.siemens.com/cs/ww/en/ps/3SU1401-1MC50-1CA1>

Image database (product images, 2D dimension drawings, 3D models, device circuit diagrams, EPLAN macros, ...)

http://www.automation.siemens.com/bilddb/cax_de.aspx?mlfb=3SU1401-1MC50-1CA1&lang=en

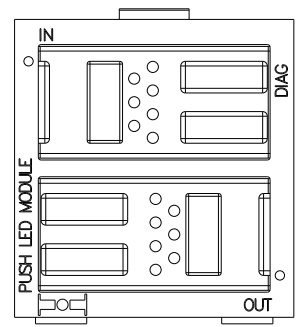
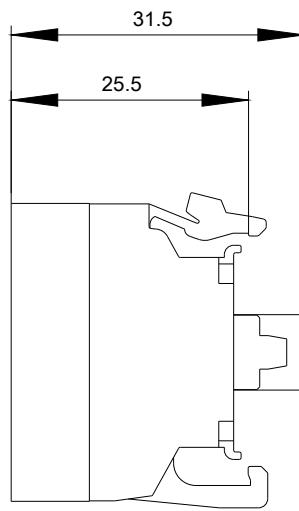
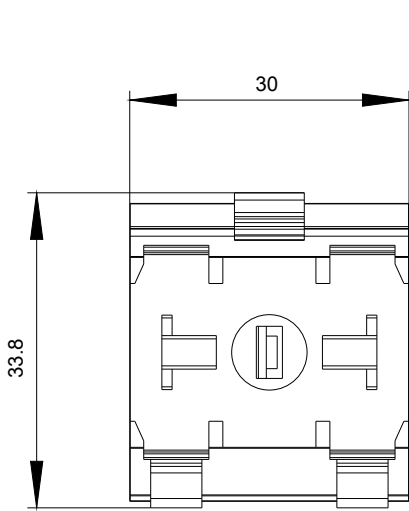

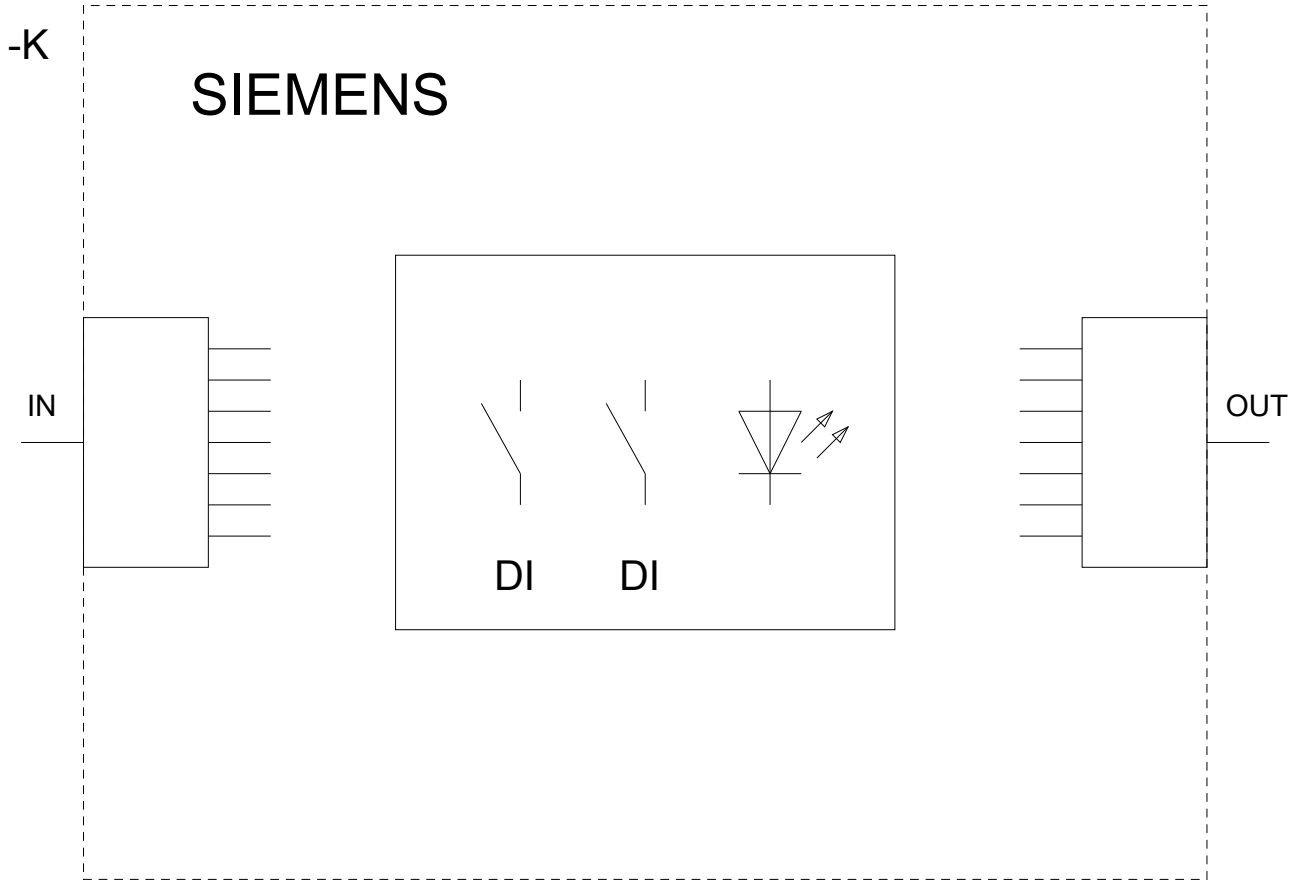

last modified:

09/25/2017