

**Food & Beverage Hygienic, TPE  
Extension Cable  
PKG4M-1-PSGH4M/TFG**

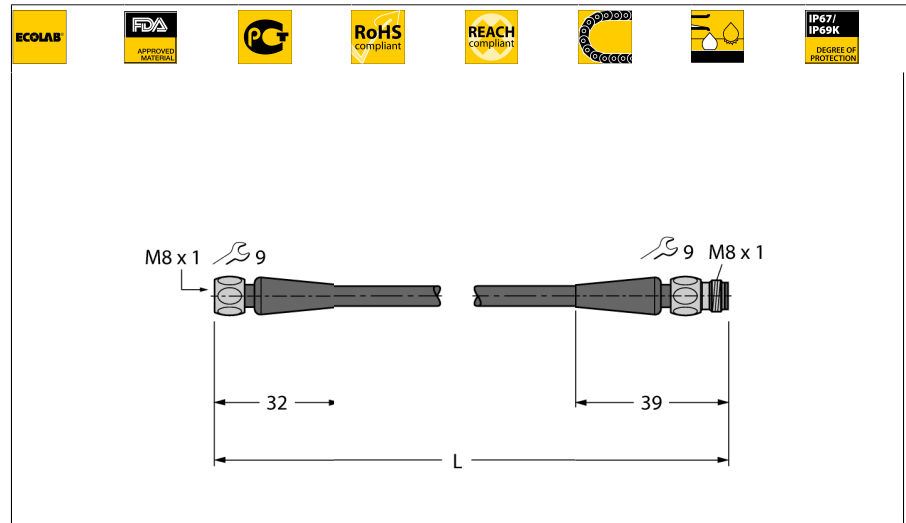

- M8 female connector, straight, 4-pin
- Stainless steel coupling nut/screw
- M8 male connector, straight, 4-pin
- Sheath material: TPE-O
- Sheath color: light gray RAL 7035
- Qualified for drag chain use
- Resistant to chemicals and microbes
- Weatherproof
- Resistant to hydrolysis acc. to DIN EN 60068-2-78
- Flexible at low temperatures
- Free from silicone and PVC
- Halogen-free acc. to DIN EN 50267-2-1, IEC 60754-1, VDE 0482-267-2-1
- Approvals: Gost, Ecolab, FDA
- RoHS and REACH compliant
- Protection classes IP67, IP69K
- Cable length: 1.0 m

**Type designation** PKG4M-1-PSGH4M/TFG  
**Ident no.** 6933516

**Connector A side**  
 Number of pins Female connector, M8 ♂ 1, Straight 4  
 Contacts Brass, CuZn, Gold-plated  
 Contact carriers Plastic, PP, Gray  
 Grip Plastic, PP, Gray  
 Coupling nut/screw Stainless steel, V4A  
 Seal Plastic, FPM/FKM  
 Protection class IP67, IP69K, A + B side screwed together  
 Mechanical lifespan > 100 Mating cycles  
 Pollution degree 3  
 Tightening torque 0.5 ... 0.6 Nm  
 (observe max. torque of counter piece!)

**Connector B side**  
 Number of pins Connector, M8x1, Straight 4 pins  
 Contacts brass, CuZn, Gold-plated  
 Contact carriers Plastic, PP, Gray  
 Grip plastic, PP, gray  
 Coupling nut/screw Stainless steel, V4A  
 Protection class IP67, IP69K, Only when screwed tight  
 Mechanical lifespan > 100 Mating cycles  
 Pollution degree 3  
 Tightening torque 0.5 ... 0.6 Nm  
 (observe max. torque of counter piece!)

**General data**  
 Cable diameter 4.6 ± 0.15mm  
 Cable length 1 m  
 Cable quality TPE-O  
 Cable color Gray  
 Core insulation TPE-E  
 Core colors BN, WH, BU, BK  
 Core cross-section 4x0.34mm<sup>2</sup>  
 Arrangement of strands 42x0.1 mm

**Electrical features at +20 °C**  
 Current 4 A  
 Rated voltage 30 V  
 Nom. Inductance 0.73 mH/km  
 Nom. capacitance 82 pF/m  
 Test voltage 2000 V

**Cable Cross-section**

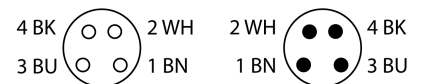
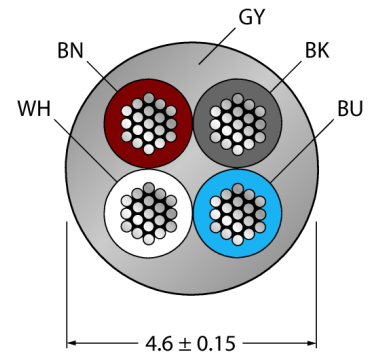

**Circuit Diagram**

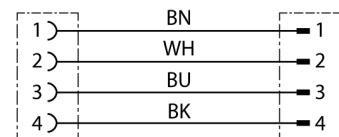

## Food & Beverage Hygienic, TPE Extension Cable PKG4M-1-PSGH4M/TFG

---

**Mechanical and chemical properties**

Max. tensile strength (static)	≤ 50 N/mm <sup>2</sup>
Max. tensile strength (dynamic)	≤ 20 N/mm <sup>2</sup>
Bending cycles	> 4 mil.
Bending radius (stationary laying)	> 5 x Ø
Bending radius (flexible use)	> 10 x Ø
Admissible acceleration	max. 5 m/s <sup>2</sup>
Admissible travel path, horizontal	5 m (at 5 m/s <sup>2</sup> )
Admissible travel path, vertical	2 m (at 5 m/s <sup>2</sup> )
Admissible traversing speed	3 m/s
Torsional stress	± 180 °/m
Ambient temperature	
Stationary	-40...+105°C
In motion	-25...+105°C
Drag chain operation	-25...+60°C