

ø8·10·12·16 AP Series Miniature Pilot Lights

Super Bright LEDs with built-in current-limiting resistor

- Space saving miniature style.
- Illumination colors: amber, blue, green, pure white, red, and yellow (blue and pure white available for AP8M and AP1M only)
- Marking is available on flat lens units. (except AP8M series)



*) AP8M and AP1M only

- See website for details on approvals and standards.



AP2M
AC adapter unit

AP6M
AC adapter unit
Flasher unit

Pilot Light

Input Type	Full voltage					
Model	AP2M / AP6M			AP8M / AP1M		
Rated Voltage	6V AC/DC	12V AC/DC	24V AC/DC	5V DC	12V AC/DC	24V AC/DC
Voltage Range	6V AC/DC±5%	12V AC/DC±10%	24V AC/DC±10%	5V DC±5%	12V AC/DC±10%	24V AC/DC±10%
Rated Current	5mA			4mA		
Illumination Color Code	A (amber), G (green), PW (pure white), R (red), Y (yellow)			A (amber), G (green), PW (pure white), R (red), S (blue), Y (yellow)		
Operating Temperature	-20 to +55°C (no freezing)					
Storage Temperature	-30 to +55°C (no freezing)					
Operating Humidity	45 to 85% RH (no condensation)					
Insulation Resistance	Between live and dead parts: 100 MΩ minimum (500V DC megger)					
Dielectric Strength	Between live and dead parts: 1000V, 1 minute					
Solder Terminal	Soldering 350°C maximum (3 sec)					
Applicable Wire	ø1.0 or 0.75 mm ² maximum (20 to 16 AWG)					
Weight (approx.)	AP6M: 7.5g, AP2M: 4.5g, AP1M: 2.5g, AP8M: 2.0g					
Degree of Protection	AP6M, AP2M, AP1M: IP65 AP8M: IP40 (according to IEC 60529)					



AC Adapter/DC-DC Converter (Option)

Unit	AC Adapter	DC-DC Converter
Applicable Unit	AP6M and AP2M (6V rating only)	
Rated Voltage	100/110V AC, 200/220V AC 50/60 Hz	110V DC
Voltage Range	100/110V AC±10% 200/220V AC±10%	90 to 140V
Power Consumption	1.6 VA maximum	1W maximum
Insulation Voltage	250V AC	140V DC
Insulation Resistance	Between live and dead parts: 100 MΩ minimum (500V DC megger)	
Dielectric Strength	Between live and dead parts: 2000V, 1 minute	
	Between I/O terminals: 2000V AC, 1 minute	Between I/O terminals: 1500V AC, 1 minute
Terminal Style	M3 screw	
Weight (approx.)	38g	20g

Flasher Unit (Option)

Applicable Unit	AP6M (12V and 24V DC rating only)
Rated Voltage	12/24V DC compatible
Voltage Range	12/24V DC±10%
Flashing Period	Adjustable between approximately 30 to 600 cycles per minute (period 0.1 to 2 sec)
Current Draw	4 mA (OFF) to 6 mA (ON)
Terminal Style	M3 screw
Weight (approx.)	13.5g

AP6M Series (ø16)

Shape	Operating Voltage	Part No.	Ordering No.	Package Quantity	Lens Color Code
	6V DC	AP6M266②	AP6M266②	1	Specify a lens color code in place of ② in the Part No. A: amber G: green PW: pure white R: red Y: yellow
			AP6M266②PN10	10	
	12V DC	AP6M211②	AP6M211②	1	
			AP6M211②PN10	10	
	24V DC	AP6M222②	AP6M222②	1	
			AP6M222②PN10	10	
	6V DC	AP6M166②	AP6M166②	1	
			AP6M166②PN10	10	
	12V DC	AP6M111②	AP6M111②	1	
			AP6M111②PN10	10	
	24V DC	AP6M122②	AP6M122②	1	
			AP6M122②PN10	10	

- Degree of protection: IP65 (IEC 60529)
- The LED cannot be replaced.

AC Adapter, DC-DC Converter, Flasher Unit

Unit	Operating Voltage	Part No.	Applicable Pilot Light	Package Quantity
AC Adapter	100/110V AC	AP6-016D	AP6M266② (dome: 6V DC) AP6M166② (flat: 6V DC)	1
	200/220V AC	AP6-026D		
DC-DC Converter	110V DC (90 to 140V DC)	AP6-016DD		
Flasher Unit	12/24V DC	UZ6-F10	AP6M211② (dome: 12V DC) AP6M222② (dome: 24V DC) AP6M111② (flat: 12V DC) AP6M122② (flat: 24V DC)	

Dimensions

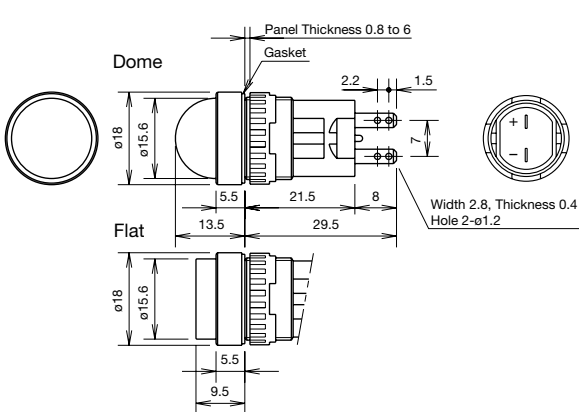

With AC Adapter, DC-DC Converter, Flasher Unit

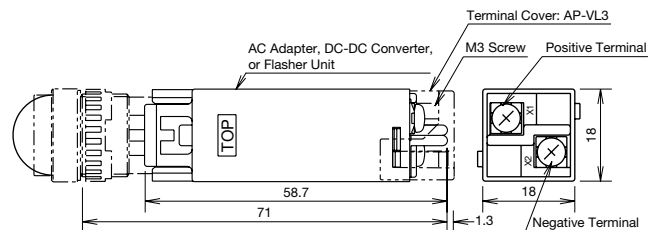

Terminal cover is not supplied.
When using terminal covers, order AP-VL3 terminal covers.

Terminal Arrangement

(Bottom View)

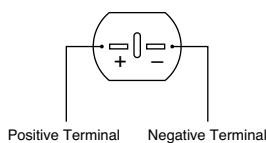

Marking Plate

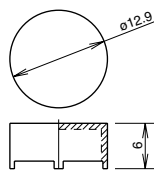

Engraving depth: 0.5 mm maximum
Marking plate material: White acrylic

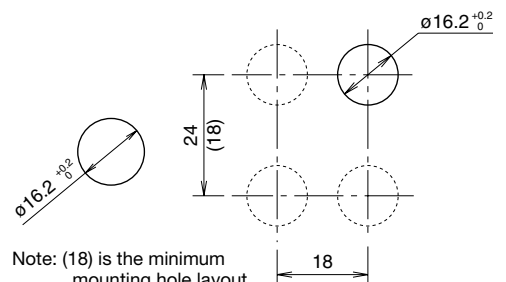

Panel Cut-out / Mounting Hole Layout



Note: (18) is the minimum mounting hole layout without AC adapter or flasher unit.

All dimensions in mm.

AP2M Series (ø12)

Shape	Operating Voltage	Part No.	Ordering No.	Package Quantity	Lens Color Code
	6V DC ±5%	AP2M266②	AP2M266②	1	Specify a lens color code in place of ② in the Part No. A: amber G: green PW: pure white R: red Y: yellow
			AP2M266②PN10	10	
	12V DC ±10%	AP2M211②	AP2M211②	1	
			AP2M211②PN10	10	
	24V DC ±10%	AP2M222②	AP2M222②	1	
			AP2M222②PN10	10	
	6V DC ±5%	AP2M166②	AP2M166②	1	
			AP2M166②PN10	10	
	12V DC ±10%	AP2M111②	AP2M111②	1	
			AP2M111②PN10	10	
	24V DC ±10%	AP2M122②	AP2M122②	1	
			AP2M122②PN10	10	

- Degree of protection: IP65 (IEC 60529)
- The LED cannot be replaced.

AC Adapter, DC-DC Converter

Unit	Operating Voltage	Part No.	Applicable Pilot Light	Package Quantity
AC Adapter	100/110V AC	AP2-016D	AP6M266② (dome: 6V DC) AP6M166② (flat: 6V DC)	1
	200/220V AC	AP2-026D		
DC-DC Converter	110V DC (90 to 140V DC)	AP2-016DD		

Dimensions

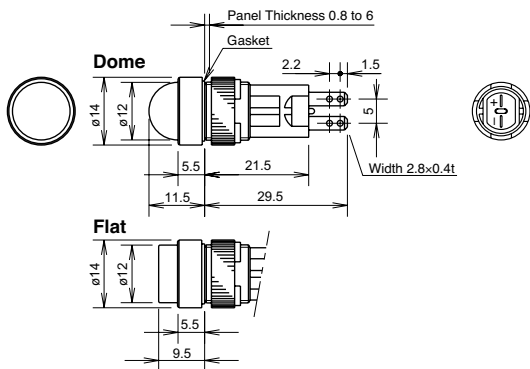

With AC Adapter or DC-DC Converter

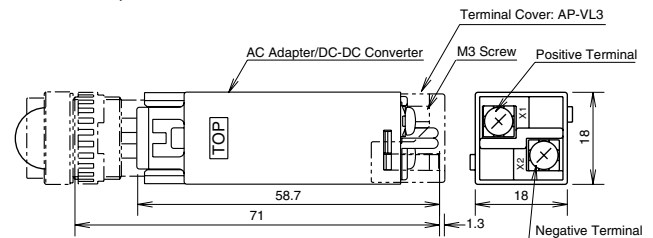

Terminal cover is not supplied.
When using terminal covers, order AP-VL3 terminal covers.

Terminal Arrangement (Bottom View)

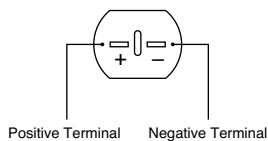

Marking Plate

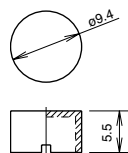

Engraving depth: 0.5 mm maximum
Marking plate material: White acrylic

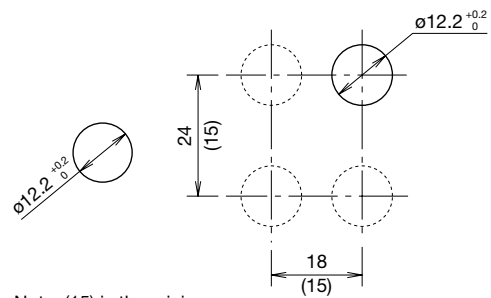

Panel Cut-out / Mounting Hole Layout



Note: (15) is the minimum mounting hole layout without AC adapter or flasher unit.

All dimensions in mm.

AP1M Series (ø10)

Shape	Operating Voltage	Part No.	Ordering No.	Package Quantity	Lens Color Code
	5V DC ±5%	AP1M255②	AP1M255②	1	Specify a lens color code in place of ② in the Part No. A: amber G: green PW: pure white R: red S: blue Y: yellow
			AP1M255②PN10	10	
	12V AC/DC ±10%	AP1M211②	AP1M211②	1	
			AP1M211②PN10	10	
	24V AC/DC ±10%	AP1M222②	AP1M222②	1	
			AP1M222②PN10	10	
	5V DC ±5%	AP1M155②	AP1M155②	1	
			AP1M155②PN10	10	
	12V AC/DC ±10%	AP1M111②	AP1M111②	1	
			AP1M111②PN10	10	
	24V AC/DC ±10%	AP1M122②	AP1M122②	1	
			AP1M122②PN10	10	

- Degree of protection: IP65 (IEC 60529)
- The LED cannot be replaced.
- Separate transformer (TWR512, TWR522, TWR542) can be used for 24V AC/DC pilot lights.

Dimensions

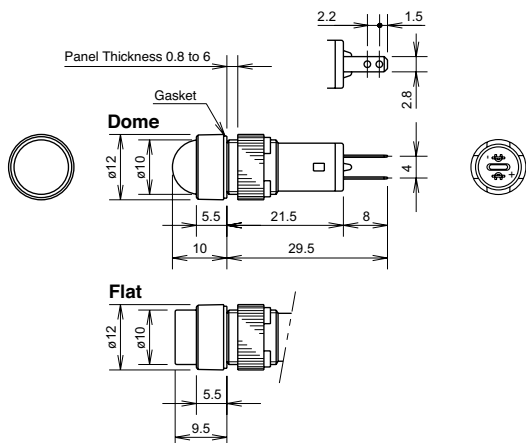

Terminal Arrangement (Bottom View)

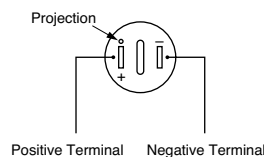

Marking Plate

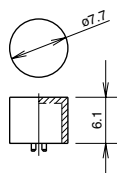

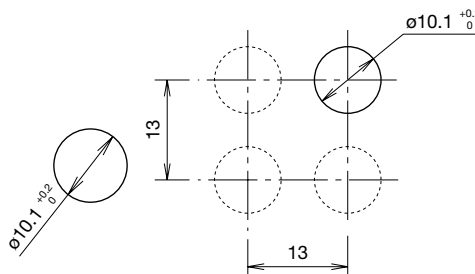

Engraving depth: 0.5 mm maximum
 Marking plate material: White acrylic

Panel Cut-out / Mounting Hole Layout



All dimensions in mm.

AP8M Series (ø8)

Shape	Operating Voltage	Part No.	Ordering No.	Package Quantity	Lens Color Code
	5V DC ±5%	AP8M255②	AP8M255②	1	Specify a lens color code in place of ② in the Part No. A: amber G: green PW: pure white R: red S: blue Y: yellow
			AP8M255②PN10	10	
	12V AC/DC ±10%	AP8M211②	AP8M211②	1	
			AP8M211②PN10	10	
	24V AC/DC ±10%	AP8M222②	AP8M222②	1	
			AP8M222②PN10	10	
	5V DC ±5%	AP8M155②	AP8M155②	1	
			AP8M155②PN10	10	
	12V AC/DC ±10%	AP8M111②	AP8M111②	1	
			AP8M111②PN10	10	
	24V AC/DC ±10%	AP8M122②	AP8M122②	1	
			AP8M122②PN10	10	

- The lens or LED cannot be removed or replaced.
- Degree of protection: IP40 (IEC 60529)
- Separate transformer (TWR512, TWR522, TWR542) can be used for 24V AC/DC pilot lights.

Dimensions

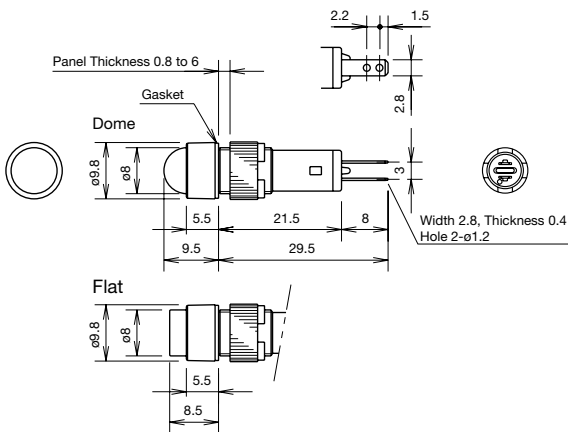

Terminal Arrangement (Bottom View)

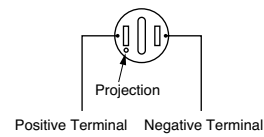

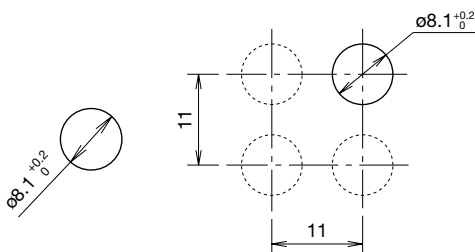

Panel Cut-out / Mounting Hole Layout







All dimensions in mm.

Accessories

Shape	For	Material	Part No.	Ordering No.	Package Quantity	Remarks										
	ø16	Metal (nickel-plated brass)	MT-001	MT-001	1	<ul style="list-style-type: none"> Used to tighten the locking ring when installing an AP unit onto a panel. Tighten the locking ring using a recommended tightening torque. <table border="1" data-bbox="1289 360 1458 479"> <thead> <tr> <th>Part No.</th> <th>Size</th> </tr> </thead> <tbody> <tr> <td>MT-001</td> <td>ø18</td> </tr> <tr> <td>MT-002</td> <td>ø14</td> </tr> <tr> <td>MT-003</td> <td>ø12</td> </tr> <tr> <td>MT-004</td> <td>ø9.5</td> </tr> </tbody> </table>	Part No.	Size	MT-001	ø18	MT-002	ø14	MT-003	ø12	MT-004	ø9.5
	Part No.		Size													
	MT-001		ø18													
	MT-002		ø14													
MT-003	ø12															
MT-004	ø9.5															
ø12	MT-002	MT-002	1													
ø10	MT-003	MT-003	1													
ø8	MT-004	MT-004	1													
		Stainless steel	MT-100	MT-100	1	<ul style="list-style-type: none"> Used to remove the AC adapter, DC-DC converter, or flasher unit. 										
	ø16	Metal (diecast) Locking ring (polyacetal)	AL-BM6	AL-BM6	1	<ul style="list-style-type: none"> Degree of protection: IP65 										
		Nitril rubber (black)	AL-B6	AL-B6PN05	5	<ul style="list-style-type: none"> Degree of protection: IP65 										
	ø12	Nitril rubber (black)	AL-B2	AL-B2PN05	5	<ul style="list-style-type: none"> Degree of protection: IP65 										
	ø10	Nitril rubber (black)	AL-B1	AL-B1PN05	5	<ul style="list-style-type: none"> Degree of protection: IP65 										
	ø8	Nitril rubber (black)	AL-B8	AL-B8PN05	5	<ul style="list-style-type: none"> Degree of protection: IP65 										

Replacement Parts for AP6M/AP2M/AP1M

Shape	For	Part No.	Ordering No.	Package Quantity	Lens Color Code	
	AP6M	Dome lens	AP6M-L2②	AP6M-L2②PN05	5	A (amber), G (green), R (red), W (white), Y (yellow) (Note 1)
		Flat lens	AP6M-L1②	AP6M-L1②PN05	5	A (amber), C (clear), G (green), R (red), Y (yellow) (Note 2)
	AP2M	Dome lens	AP2M-L2②	AP2M-L2②PN05	5	A (amber), G (green), R (red), W (white), Y (yellow) (Note 1)
		Flat lens	AP2M-L1②	AP2M-L1②PN05	5	A (amber), C (clear), G (green), R (red), Y (yellow) (Note 2)
	AP1M	Dome lens	AP1M-L2②	AP1M-L2②PN05	5	A (amber), G (green), R (red), S (blue), W (white), Y (yellow) (Note 1)
		Flat lens	AP1M-L1②	AP1M-L1②PN05	5	A (amber), C (clear), G (green), R (red), S (blue), Y (yellow) (Note 2)
	AP6M		AP6M-P1W	AP6M-P1WPN05	5	White
	AP2M	Flat lens	AP2M-P1W	AP2M-P1WPN05	5	
	AP1M		AP1M-PN1W	AP1M-PN1WPN05	5	
	AP1M	Dome lens	AP1M-PN2W	AP1M-PN2WPN05	5	White
	AP6M AP2M	AC adapter DC-DC converter Flasher unit	AP-VL3	AP-VL3	1	

Specify a lens color code in place of ② in the Ordering No.

Note 1: On the dome lens, use a white (W) lens for pure white P(W) illumination.

Note 2: On the flat lens, use a clear (C) lens for pure white (PW) illumination.

Safety Precautions

- Turn off power to the AP series pilot lights before installation, removal, wiring, maintenance, and inspection. Failure to turn power off may cause electrical shocks or fire hazard.
- For wiring, use wires of proper size to meet the voltage and current requirements. Improper wiring may cause overheating and

create a fire hazard. Tighten the M3 terminal screws to a torque of 0.6 to 1.0 N·m. Failure to tighten terminal screws may cause overheating and fire.

Instructions

Panel Mounting

When mounting the AP series pilot lights on a panel, use the optional locking ring wrench. Do not use pliers. Excessive tightening will damage the locking ring.

Unit	Tightening Torque
AP6M	0.88 N·m
AP2M	0.78 N·m
AP1M	0.29 N·m
AP8M	0.29 N·m

Installing the AC Adapter, DC-DC Converter, and Flasher Unit

1. Make sure that the voltage rating and terminal style of the AP series pilot lights are applicable to the AC adapter, DC-DC Converter, and flasher units.
2. Install the pilot light into a panel cut-out before mounting an AC adapter, DC-DC Converter, or flasher unit. Note that the pilot light cannot be installed in a panel cut-out with an AC adapter, DC-DC Converter, or flasher unit mounted.
3. When installing an AC adapter, DC-DC Converter, or flasher unit, make sure that the TOP marking is on the same side as the TOP marking of the pilot light. AC adapter, DC-DC Converter, and flasher unit are snapped on to the back of the pilot light.
4. To remove the AC adapter, DC-DC Converter, or flasher unit, insert the tip of the removal tool into the joint hook and pull towards you as shown in the photo below.

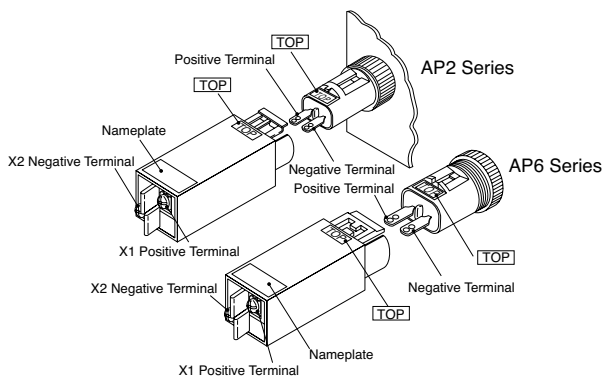
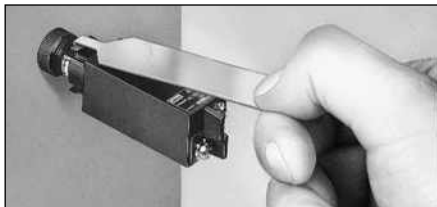

Note: Do not apply excessive force to terminals X1 and X2 during wiring.

5. When using an AC adapter, DC-DC Converter, or flasher unit where the units are subjected to noise, connect a noise suppressor across terminals X1 and X2 as shown in the diagram below.

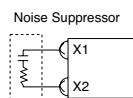

Wiring

1. Note the positive and negative polarities when wiring DC types.
2. All DC type AP series pilot lights contain a current limiting resistor, eliminating the need for external resistors.
3. Solder the terminal at 350°C within 3 seconds using a 60W soldering iron. SnAgCu type lead-free solder is recommended. When soldering, do not touch the pilot light housing with the soldering iron. Also ensure that no tensile force is applied to the terminal. Do not bend the terminal or apply excessive force to the terminal. Use a non-corrosive rosin flux.

DC-DC Converter

DC-DC converters employ an electronic oscillating circuit. Oscillating sounds may be heard depending on operating conditions, but will not affect performance characteristics.

Marking

AP6M, AP2M, and AP1M round flat lenses contain a white marking plate inside the lens. (AP8M lens cannot be removed.)

Flasher Unit

Pierce the round mark on the nameplate on top of the flasher unit with a flat screwdriver and adjust the variable resistor inside. Turn clockwise to lengthen the flashing period.

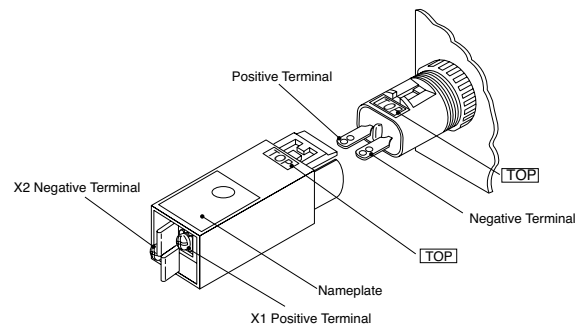

Note: Do not apply excessive force to terminals X1 and X2 during wiring.

Ordering Terms and Conditions

Thank you for using IDEC Products.

By purchasing products listed in our catalogs, datasheets, and the like (hereinafter referred to as "Catalogs") you agree to be bound by these terms and conditions. Please read and agree to the terms and conditions before placing your order.

1. Notes on contents of Catalogs

- (1) Rated values, performance values, and specification values of IDEC products listed in this Catalog are values acquired under respective conditions in independent testing, and do not guarantee values gained in combined conditions.
Also, durability varies depending on the usage environment and usage conditions.
- (2) Reference data and reference values listed in Catalogs are for reference purposes only, and do not guarantee that the product will always operate appropriately in that range.
- (3) The specifications / appearance and accessories of IDEC products listed in Catalogs are subject to change or termination of sales without notice, for improvement or other reasons.
- (4) The content of Catalogs is subject to change without notice.

2. Note on applications

- (1) If using IDEC products in combination with other products, confirm the applicable laws / regulations and standards.
Also, confirm that IDEC products are compatible with your systems, machines, devices, and the like by using under the actual conditions. IDEC shall bear no liability whatsoever regarding the compatibility with IDEC products.
- (2) The usage examples and application examples listed in Catalogs are for reference purposes only. Therefore, when introducing a product, confirm the performance and safety of the instruments, devices, and the like before use. Furthermore, regarding these examples, IDEC does not grant license to use IDEC products to you, and IDEC offers no warranties regarding the ownership of intellectual property rights or non-infringement upon the intellectual property rights of third parties.
- (3) When using IDEC products, be cautious when implementing the following.
 - i. Use of IDEC products with sufficient allowance for rating and performance
 - ii. Safety design, including redundant design and malfunction prevention design that prevents other danger and damage even in the event that an IDEC product fails
 - iii. Wiring and installation that ensures the IDEC product used in your system, machine, device, or the like can perform and function according to its specifications
- (4) Continuing to use an IDEC product even after the performance has deteriorated can result in abnormal heat, smoke, fires, and the like due to insulation deterioration or the like. Perform periodic maintenance for IDEC products and the systems, machines, devices, and the like in which they are used.
- (5) IDEC products are developed and manufactured as general-purpose products for general industrial products. They are not intended for use in the following applications, and in the event that you use an IDEC product for these applications, unless otherwise agreed upon between you and IDEC, IDEC shall provide no guarantees whatsoever regarding IDEC products.
 - i. Use in applications that require a high degree of safety, including nuclear power control equipment, transportation equipment (railroads / airplanes / ships / vehicles / vehicle instruments, etc.), equipment for use in outer space, elevating equipment, medical instruments, safety devices, or any other equipment, instruments, or the like that could endanger life or human health
 - ii. Use in applications that require a high degree of reliability, such as provision systems for gas / waterworks / electricity, etc., systems that operate continuously for 24 hours, and settlement systems
 - iii. Use in applications where the product may be handled or used deviating from the specifications or conditions / environment listed in the Catalogs, such as equipment used outdoors or applications in environments subject to chemical pollution or electromagnetic interference
If you would like to use IDEC products in the above applications, be sure to consult with an IDEC sales representative.

3. Inspections

We ask that you implement inspections for IDEC products you purchase without delay, as well as thoroughly keep in mind management/maintenance regarding handling of the product before and during the inspection.

4. Warranty

- (1) Warranty period
The warranty period for IDEC products shall be one (1) year after purchase or delivery to the specified location. However, this shall not apply in cases where there is a different specification in the Catalogs or there is another agreement in place between you and IDEC.
- (2) Warranty scope
Should a failure occur in an IDEC product during the above warranty period for reasons attributable to IDEC, then IDEC shall replace or repair that product, free of charge, at the purchase location / delivery location of the product, or an IDEC service base. However, failures caused by the following reasons shall be deemed outside the scope of this warranty.
 - i. The product was handled or used deviating from the conditions / environment listed in the Catalogs
 - ii. The failure was caused by reasons other than an IDEC product
 - iii. Modification or repair was performed by a party other than IDEC
 - iv. The failure was caused by a software program of a party other than IDEC
 - v. The product was used outside of its original purpose
 - vi. Replacement of maintenance parts, installation of accessories, or the like was not performed properly in accordance with the user's manual and Catalogs
 - vii. The failure could not have been predicted with the scientific and technical standards at the time when the product was shipped from IDEC
 - viii. The failure was due to other causes not attributable to IDEC (including cases of force majeure such as natural disasters and other disasters)Furthermore, the warranty described here refers to a warranty on the IDEC product as a unit, and damages induced by the failure of an IDEC product are excluded from this warranty.

5. Limitation of liability

The warranty listed in this Agreement is the full and complete warranty for IDEC products, and IDEC shall bear no liability whatsoever regarding special damages, indirect damages, incidental damages, or passive damages that occurred due to an IDEC product.

6. Service scope

The prices of IDEC products do not include the cost of services, such as dispatching technicians. Therefore, separate fees are required in the following cases.

- (1) Instructions for installation / adjustment and accompaniment at test operation (including creating application software and testing operation, etc.)
- (2) Maintenance inspections, adjustments, and repairs
- (3) Technical instructions and technical training
- (4) Product tests or inspections specified by you

The above content assumes transactions and usage within your region. Please consult with an IDEC sales representative regarding transactions and usage outside of your region. Also, IDEC provides no guarantees whatsoever regarding IDEC products sold outside your region.

IDEC CORPORATION

Head Office 6-64, Nishi-Miyahara-2-Chome, Yodogawa-ku, Osaka 532-0004, Japan

 www.idec.com

USA IDEC Corporation
EMEA APEM SAS

Singapore IDEC Izumi Asia Pte. Ltd.
Thailand IDEC Asia (Thailand) Co., Ltd.
India IDEC Controls India Private Ltd.

China IDEC (Shanghai) Corporation
IDEC Izumi (H.K.) Co., Ltd.
Taiwan IDEC Taiwan Corporation

Japan IDEC Corporation

Specifications and other descriptions in this brochure are subject to change without notice.

2022 IDEC Corporation, All Rights Reserved.

