



# Diffuse mode sensor RL31-8-1200-RT/73c/136



- Highly visible LED
- Powerful push-pull output
- Red transmission light
- Compact and stable housing
- Protection class II

Diffuse mode sensor, plastic housing, 1200 mm adjustable detection range, red light, light on, push-pull output, M12 plug



## Dimensions

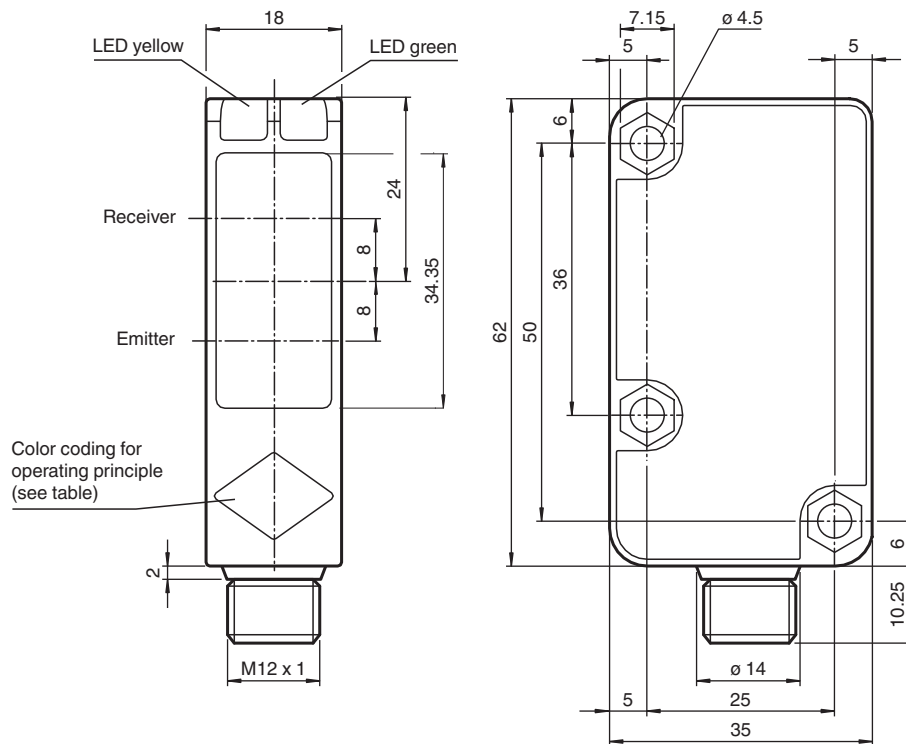

Operating principle	color
Retroreflective sensor with polarisation filter	green
Retroreflective sensor	blue
Diffusive mode sensor	white
Thru-beam sensor	grey
Diffusive mode sensor with background suppression	red

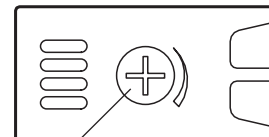

Sensing range adjuster

## Technical Data

### General specifications

Detection range 0 ... 1200 mm adjustable

Release date: 2022-08-08 Date of issue: 2022-08-08 Filename: 186473\_eng.pdf

Refer to "General Notes Relating to Pepperl+Fuchs Product Information".

Pepperl+Fuchs Group  
www.pepperl-fuchs.com

USA: +1 330 486 0001  
fa-info@us.pepperl-fuchs.com

Germany: +49 621 776 1111  
fa-info@de.pepperl-fuchs.com

Singapore: +65 6779 9091  
fa-info@sg.pepperl-fuchs.com

**PF** PEPPERL+FUCHS

## Technical Data

Detection range max.		0 ... 1200 mm
Reference target		standard white, 100 mm x 100 mm
Light source		LED
Light type		modulated visible red light , 630 nm
Diameter of the light spot		approx. 25 mm at a distance of 1.2 m
Opening angle		2 °
Ambient light limit		50000 Lux ; according EN 60947-5-2
<b>Functional safety related parameters</b>		
MTTF <sub>d</sub>		920 a
Mission Time (T <sub>M</sub> )		20 a
Diagnostic Coverage (DC)		0 %
<b>Indicators/operating means</b>		
Operation indicator		LED green: power on
Function indicator		LED yellow, lights up with receiver lit
Control elements		Sensing range adjuster
<b>Electrical specifications</b>		
Operating voltage	U <sub>B</sub>	10 ... 30 V DC
Ripple		10 %
No-load supply current	I <sub>0</sub>	≤ 20 mA
<b>Output</b>		
Switching type		light-on
Signal output		2 push-pull (4 in 1) outputs, short-circuit protected, reverse polarity protected
Switching voltage		max. 30 V DC
Switching current		max. 100 mA
Voltage drop	U <sub>d</sub>	≤ 1.5 V
Switching frequency	f	≤ 500 Hz
Response time		≤ 1 ms
<b>Conformity</b>		
Product standard		EN 60947-5-2
<b>Approvals and certificates</b>		
EAC conformity		TR CU 020/2011
Protection class		II , rated insulation voltage ≤ 250 V AC with pollution degree 1-2 according to IEC 60664-1 Output circuit basis insulation of input circuit according to EN 50178, rated insulation voltage 240 V AC
UL approval		cULus Listed, Class 2 Power Source, Type 1 enclosure
CCC approval		CCC approval / marking not required for products rated ≤36 V
<b>Ambient conditions</b>		
Ambient temperature		-30 ... 55 °C (-22 ... 131 °F)
Storage temperature		-40 ... 70 °C (-40 ... 158 °F)
<b>Mechanical specifications</b>		
Housing width		18 mm
Housing height		62 mm
Housing depth		35 mm
Degree of protection		IP67
Connection		4-pin, M12 x 1 connector
<b>Material</b>		
Housing		Polycarbonate
Optical face		PMMA
Mass		25 g

## Connection Assignment

Option:

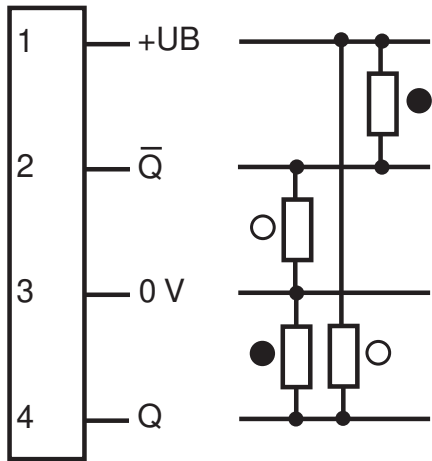

## Connection Assignment



Wire colors in accordance with EN 60947-5-2

- 1 | BN (brown)
- 2 | WH (white)
- 3 | BU (blue)
- 4 | BK (black)

## Assembly

Release date: 2022-08-08 Date of issue: 2022-08-08 Filename: 186473\_eng.pdf

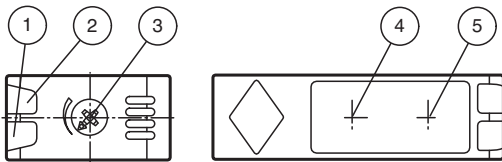



1	Operating display	green
2	Signal display	yellow
3	Sensing range adjuster	
4	Emitter	
5	Receiver	

Refer to "General Notes Relating to Pepperl+Fuchs Product Information".

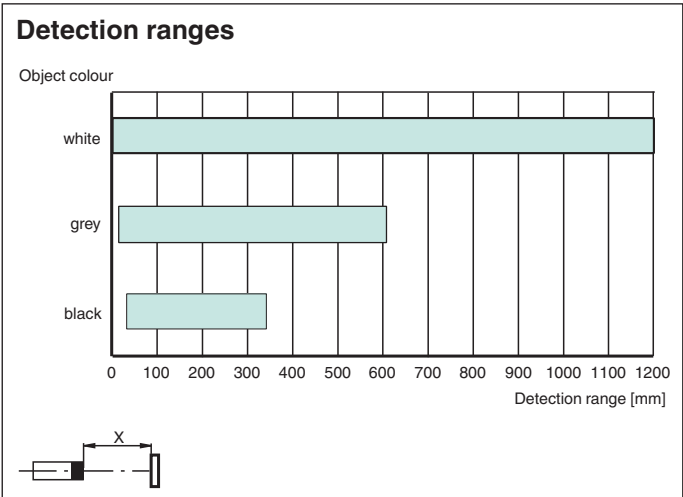
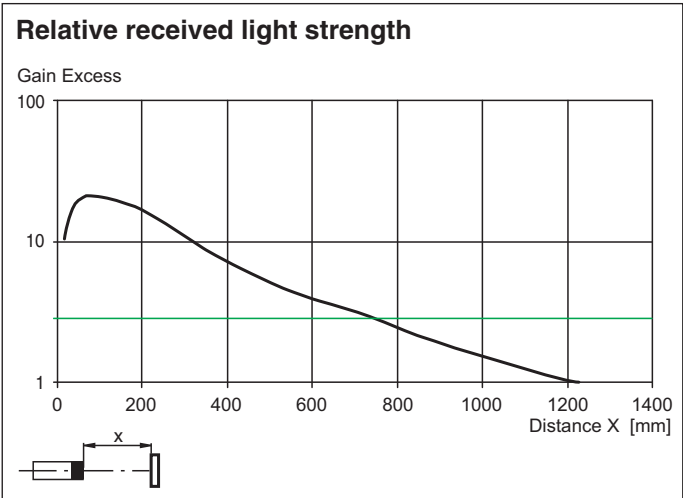
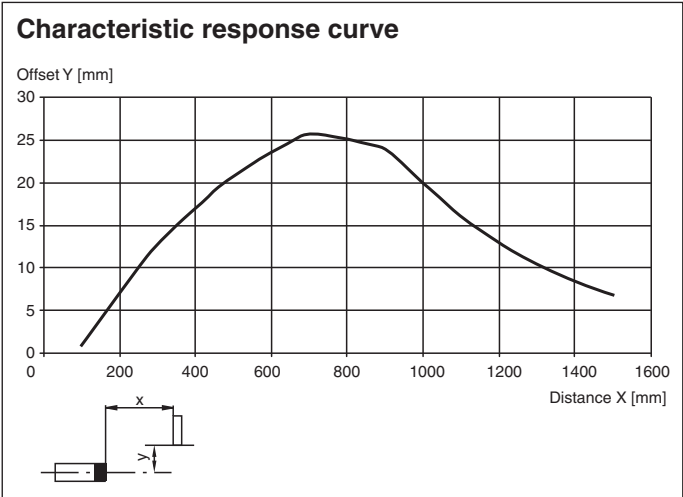
## Characteristic Curve







## Accessories

	<b>OMH-RL31-01</b>	Mounting bracket
	<b>OMH-RL31-02</b>	Mounting bracket narrow
	<b>OMH-RL31-03</b>	Mounting bracket narrow

Release date: 2022-08-08 Date of issue: 2022-08-08 Filename: 186473\_eng.pdf

## Accessories

	<b>OMH-RL31-04</b>	Mounting aid for round steel $\varnothing$ 12 mm or sheet 1.5 mm ... 3 mm
	<b>OMH-RL31-05</b>	Mounting bracket for mounting on flat surfaces with 2 M4 screws
	<b>OMH-RL31-06</b>	Stainless steel mounting bracket with adjustable half clamp on the side
	<b>V1-G-2M-PUR</b>	Female cordset single-ended M12 straight A-coded, 4-pin, PUR cable grey
	<b>V1-W-2M-PUR</b>	Female cordset single-ended M12 angled A-coded, 4-pin, PUR cable grey