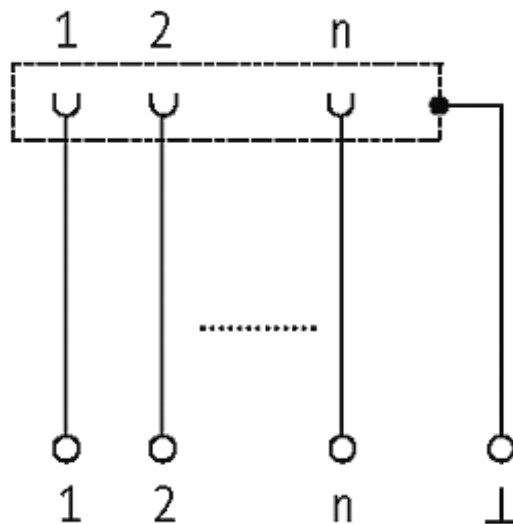
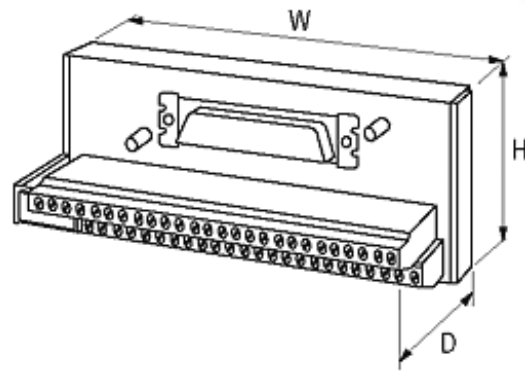

SV-SUB D 15 .-KL FOR SIGNAL TRANSFER

125 VAC/DC / 2 A

15-pole
Screw terminals[Link to Product](#)**Illustration**

stay connected

Product may differ from Image

Technical Data

Operating voltage	max. 125 V AC/150 V DC
Operating current per bit	max. 2 A
Material group	(EN 60664-1) over voltage, category II
Plug connector	Standard UNC 4-40 screw thread bolt (EN 60807)

General data

Mounting method	DIN-rail mountable (EN 60715)
Temperature range	-20...+70 °C
Dimensions H × W × D	63×75×48 mm

Commercial data

country of origin	CZ
customs tariff number	85369010
minimum order quantity	1