

MS8607-02BA01

PHT (Pressure Humidity Temperature)
Digital Combination Sensor

SPECIFICATIONS

- Integrated pressure, humidity and temperature sensor
- QFN package 5 x 3 x 1 mm³
- Operating range: 10 to 2000 mbar, 0%RH to 100%RH, -40 to 85 °C
- High-resolution module: 0.016 mbar, 0.04%RH, 0.01°C
- Supply voltage: 1.5 to 3.6 V
- Fully factory calibrated sensor
- I²C interface

FEATURES

FIELD OF APPLICATION

- Smart phones and Tablet PCs
- HVAC applications
- Weather stations
- Printers
- Home appliance and humidifiers

The MS8607 is the novel digital combination sensor, providing three environmental physical measurements all-in-one: pressure, humidity, and temperature (PHT). This product is suitable for applications requiring ultra-low power consumption, high accuracy and compactness are critical. High pressure resolution combined with high PHT linearity make the MS8607 a suitable candidate for environmental monitoring and altimeters in personal devices, as well as applications such as HVAC and weather stations. This new sensor module generation is based on leading MEMS technologies, experience and know-how in high volume manufacturing of sensor modules, which has been widely used for over a decade.

Sensor Performances (V _{DD} = 3 V)									
Characteristics	Pressure [mbar]			Relative Humidity [%RH]			Temperature [°C]		
	Min	Typ	Max	Min	Typ	Max	Min	Typ	Max
Max. Operating Range	10		2000	0		100	-40		+85
Absolute Accuracy @25°C	300...1100mbar			20...80%RH			@ 25°C		
	-2		2	-3		3	-1		1
Resolution (highest mode)		0.016			0.04			0.01	

PERFORMANCE SPECIFICATIONS

ABSOLUTE MAXIMUM RATINGS

Parameter	Symbol	Condition	Min.	Typ.	Max.	Unit
Supply voltage	V _{DD}		-0.3		3.6	V
Storage temperature	T _S		-40		85	°C
Overpressure	P _{max}			6		bar
Maximum Soldering Temperature	T _{max}	40 sec max			250	°C
ESD rating		Human Body Model	-2		2	kV
Latch up		JEDEC standard No 78	-100		100	mA

ELECTRICAL CHARACTERISTICS

Parameter	General electrical characteristics					
	Symbol	Condition	Min.	Typ.	Max.	Unit
Operating Supply voltage	V _{DD}		1.5	3.0	3.6	V
Operating Temperature	T		-20	+25	+85	°C
VDD to GND Capacitor			220	470		nF
Supply current P or T (1 Pressure or temperature conversion per sec.)	I _{PT}	OSR 8192 4096 2048 1024 512 256		20.09 10.05 5.02 2.51 1.26 0.63		μA
Supply current H (1 humidity conversion per sec.)	I _H	OSR 8192 4096 2048 1024		6.22 3.11 1.56 0.78		μA
Peak supply current (during P or T conversion)				1.25		mA
Peak supply current (during humidity conversion)				0.45		mA
Standby supply current		@ 25°C, V _{DD} = 3V		0.03	0.24	μA

	Pressure and temperature				Relative humidity			Unit
	Condition	Min.	Typ.	Max.	Min.	Typ.	Max.	
ADC Output Word			24			16		bit
ADC Conversion time ⁽³⁾	OSR 8192 4096 2048 1024 512 256		16.44 8.22 4.13 2.08 1.06 0.54	17.2 8.61 4.32 2.17 1.10 0.56		13.82 6.98 3.55 1.84 - -	15.89 8.03 4.08 2.12 - -	ms
Heater: power dissipation and temperature increase over humidity sensor						2 - 13 0.5 - 1.5		mW °C
Low battery indicator accuracy				±50 (Typ.)				mV

(3): Maximum values must be applied to determine waiting times in I²C communication

PERFORMANCE SPECIFICATIONS (CONTINUED)

PHT CHARACTERISTICS (V_{DD} = 3.0 V, T = 25 °C UNLESS OTHERWISE NOTED)

		Pressure [mbar]			Relative Humidity [%RH]			Temperature [°C]		
		Min.	Typ.	Max.	Min.	Typ.	Max.	Min.	Typ.	Max.
Operating Range		300		1200	0		100	-40		85
Extended Range ⁽⁴⁾		10		2000						
Absolute Accuracy @25°C		300...1100 mbar			20 ...80%RH			@25°C		
		-2		2	-3		3	-1		1
Absolute Accuracy		300...1100mbar, -20...85°C			5...95%RH			-20...85°C		
		-4		4	-5		5	-2		2
Relative Accuracy @25°C		700...1000 mbar ⁽⁵⁾								
			±0.1 ⁽⁶⁾							
Resolution RMS ⁽⁷⁾	OSR 8192		0.016			0.04			0.002	
	4096		0.021			-			0.003	
	2048		0.028			-			0.004	
	1024		0.039			0.7			0.006	
	512		0.062						0.009	
	256		0.11						0.012	
Maximum error with supply voltage (Condition)			±0.5			±0.25			±0.3	
		(V _{DD} = 1.5 V ... 3.6 V)								
Long-term stability			±1 / year			±0.5 / year			±0.3 / year	
Reflow soldering impact			-0.6			2				
Recovering time after reflow ⁽⁸⁾			5 days			5 days				
Response Time			< 5ms			5 sec.				
(Condition)		(at 63% of signal recovery, From 33%RH to 75%RH, At 3m/s air flow)								

(4): Linear range of ADC

(5): Auto-zero at one pressure point

(6): Characterized value performed on qualification devices

(7): Characterization performed sequentially (P&T conversion followed by H conversion)

(8): Recovering time at least 66% of the reflow impact

DIGITAL INPUTS (SDA, SCL)

Parameter	Symbol	Conditions	Min.	Typ.	Max.	Unit
Serial data clock	SCL				400	kHz
Input high voltage	V _{IH}		80% V _{DD}		100% V _{DD}	V
Input low voltage	V _{IL}		0% V _{DD}		20% V _{DD}	V

DIGITAL OUTPUTS (SDA)

Parameter	Symbol	Conditions	Min.	Typ.	Max.	Unit
Output high voltage	V _{OH}	I _{source} = 1 mA	80% V _{DD}		100% V _{DD}	V
Output low voltage	V _{OL}	I _{sink} = 1 mA	0% V _{DD}		20% V _{DD}	V
Load Capacitance	C _{LOAD}			16		pF

PERFORMANCE CHARACTERISTICS

PHT ACCURACY AND PHT ERROR VERSUS SUPPLY VOLTAGE (TYPICAL)

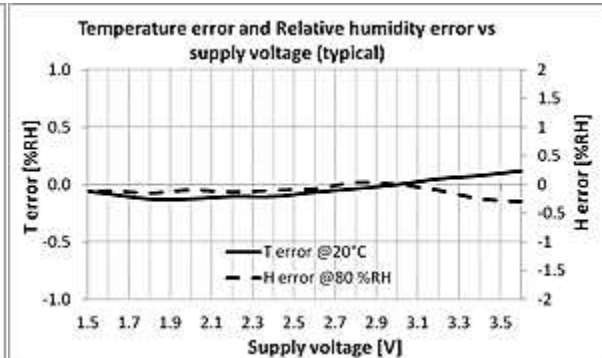
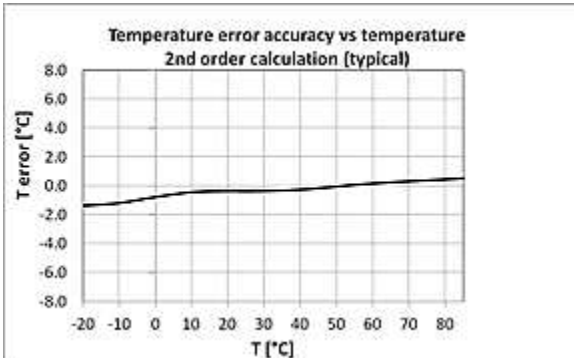
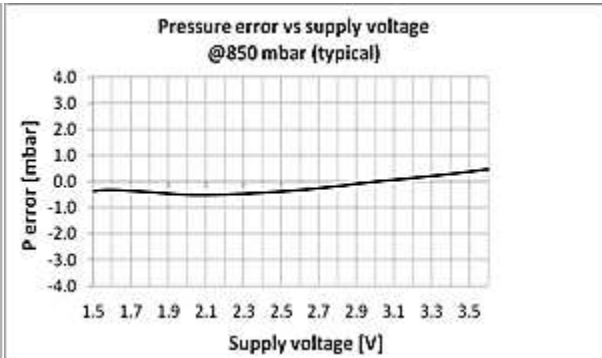
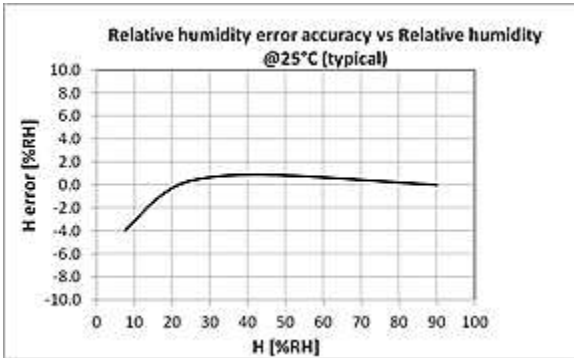
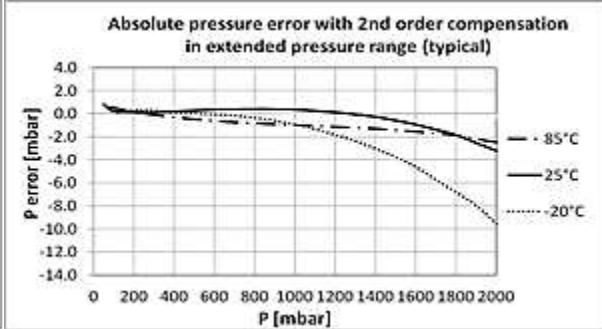
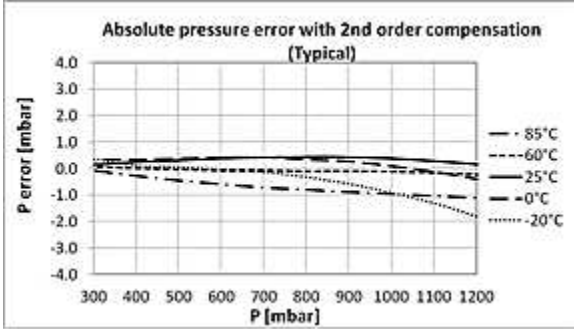

FUNCTIONAL DESCRIPTION

GENERAL

The MS8607 includes two sensors with distinctive MEMS technologies to measure pressure, humidity and temperature. The first sensor is a piezo-resistive sensor providing pressure and temperature. The second sensor is a capacitive type humidity sensor providing relative humidity. Each sensor is interfaced to a $\Delta\Sigma$ ADC integrated circuit for the digital conversion. The MS8607 converts both analog output voltages to a 24-bit digital value for the pressure and temperature measurements, and a 12-bit digital value for the relative humidity measurement.

SERIAL I²C INTERFACE

The external microcontroller clocks in the data through the input SCL (Serial CLock) and SDA (Serial DAta). Both sensors respond on the same pin SDA which is bidirectional for the I²C bus interface. Two distinct I²C addresses are used (one for pressure and temperature, the other for relative humidity, see Figure 2).

Module reference	Mode	Pins used
MS860702BA01	I ² C	SDA, SCL

Figure 1: Communication Protocol and pins

Sensor type	I ² C address (binary value)	I ² C address (hex. value)
Pressure and Temperature P&T	1110110	0x76
Relative Humidity RH	1000000	0x40

Figure 2: I²C addresses

COMMANDS FOR PRESSURE AND TEMPERATURE

For pressure and temperature sensing, five commands are possible:

1. Reset
2. Read PROM P&T (112 bit of calibration words)
3. D1 conversion
4. D2 conversion
5. Read ADC (24 bit pressure / temperature)

Each command is represented over 1 byte (8 bits) as described in Figure 3. After ADC read commands, the device will return 24 bit result and after the PROM read 16 bit results. The address of the PROM is embedded inside of the read PROM P&T command using the a2, a1 and a0 bits.

Bit number	Command byte								hex value
	7	6	5	4	3	2	1	0	
Bit name	PROM	CONV	-	Typ	Ad2/ Os2	Ad1/ Os1	Ad0/ Os0	Stop	
Command									
Reset	0	0	0	1	1	1	1	0	0x1E
Convert D1 (OSR=256)	0	1	0	0	0	0	0	0	0x40
Convert D1 (OSR=512)	0	1	0	0	0	0	1	0	0x42
Convert D1 (OSR=1024)	0	1	0	0	0	1	0	0	0x44
Convert D1 (OSR=2048)	0	1	0	0	0	1	1	0	0x46
Convert D1 (OSR=4096)	0	1	0	0	1	0	0	0	0x48
Convert D1 (OSR=8192)	0	1	0	0	1	0	1	0	0x4A
Convert D2 (OSR=256)	0	1	0	1	0	0	0	0	0x50
Convert D2 (OSR=512)	0	1	0	1	0	0	1	0	0x52
Convert D2 (OSR=1024)	0	1	0	1	0	1	0	0	0x54
Convert D2 (OSR=2048)	0	1	0	1	0	1	1	0	0x56
Convert D2 (OSR=4096)	0	1	0	1	1	0	0	0	0x58
Convert D2 (OSR=8192)	0	1	0	1	1	0	1	0	0x5A
ADC Read	0	0	0	0	0	0	0	0	0x00
PROM Read P&T	1	0	1	0	Ad2	Ad1	Ad0	0	0xA0 to 0xAE

Figure 3: Command structure for pressure and temperature sensing

COMMANDS FOR RELATIVE HUMIDITY

For relative humidity sensing, six commands are possible:

1. Reset
2. Write user register
3. Read user register
4. Measure RH (Hold master)
5. Measure RH (No Hold master)
6. PROM read RH

Each I2C communication message starts with the start condition and it is ended with the stop condition. The I²C address for humidity sensing is 1000000. The address of the PROM is embedded inside of the PROM read command using the a2, a1 and a0 bits. Figure 4 shows the commands with their respective code:

Bit number	8 bits Command								hex value
	7	6	5	4	3	2	1	0	
Command :									
1. Reset	1	1	1	1	1	1	1	0	0xFE
2. Write user register	1	1	1	0	0	1	1	0	0xE6
3. Read user register	1	1	1	0	0	1	1	1	0xE7
4. Measure RH (Hold master)	1	1	1	0	0	1	0	1	0xE5
5. Measure RH (No Hold master)	1	1	1	1	0	1	0	1	0xF5
6. PROM read RH	1	0	1	0	adr2	adr1	adr0	0	0xA0 to 0xAE

Figure 4: command structure for relative humidity sensing

USER REGISTER

The user register is used to configure several operating modes of the humidity sensor (resolution measurements, heater) and monitor the battery state. The possible configurations of the user register are described in the table below.

User register Bit	Bit Configuration/Coding	Default value																				
bit 7, bit 0	Measurement resolution	'00'																				
	<table border="1"> <thead> <tr> <th>Bit 7</th> <th>Bit 0</th> <th>OSR</th> <th>Resolution</th> </tr> </thead> <tbody> <tr> <td>0</td> <td>0</td> <td>4096</td> <td>Highest</td> </tr> <tr> <td>0</td> <td>1</td> <td>2048</td> <td></td> </tr> <tr> <td>1</td> <td>0</td> <td>1024</td> <td></td> </tr> <tr> <td>1</td> <td>1</td> <td>256</td> <td>Lowest</td> </tr> </tbody> </table>		Bit 7	Bit 0	OSR	Resolution	0	0	4096	Highest	0	1	2048		1	0	1024		1	1	256	Lowest
	Bit 7		Bit 0	OSR	Resolution																	
	0		0	4096	Highest																	
	0		1	2048																		
1	0	1024																				
1	1	256	Lowest																			
bit 6	Battery state: '0' VDD>2.25V '1' VDD<2.25V	'0'																				
bit 3,4,5	Reserved	'000'																				
bit 2	on-chip heater: '0' heater disabled '1' heater enabled	'0'																				
bit 1	Reserved	'0'																				

Figure 5: description of the user register

- Bit 7 and bit 0 configure the measurement resolution (highest resolution OSR 4096, lowest OSR 256).
- Bit 6 refers to the “Battery state”, which can be monitored.
- Bits 1,3,4,5 are reserved bits, which must not be changed and default values of respective reserved bits may change over time without prior notice. Therefore, for any writing to user register, default values of reserved bits must be read first.
- Bit 2 configures the heater. It can be used for functionality diagnosis: relative humidity drops upon rising temperature. The heater consumes about 5.5mW and provides a temperature increase of approximately 0.5-1.5°C over the humidity sensor.

PRESSURE AND TEMPERATURE CALCULATION

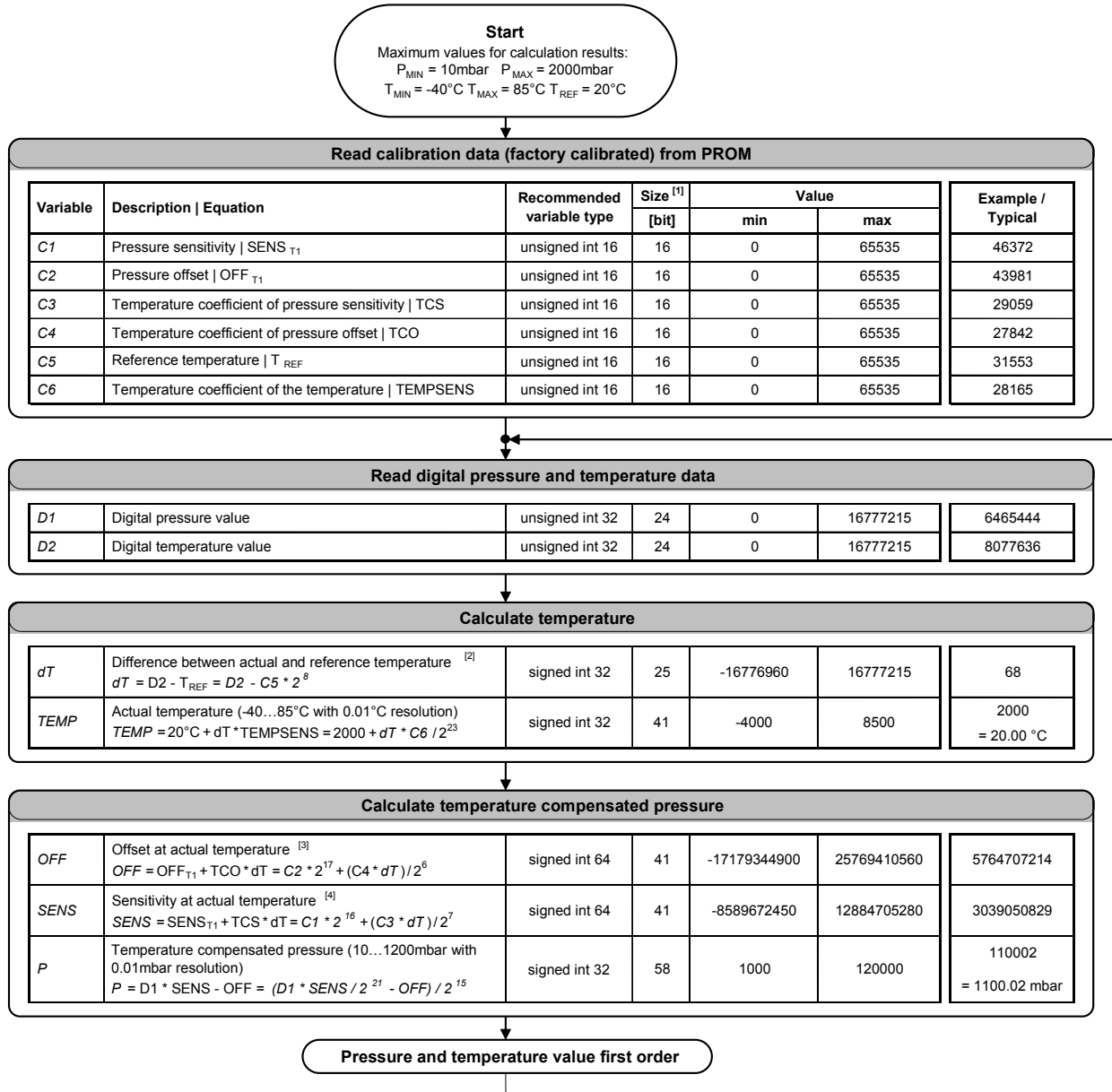

- Notes
- [1] Maximal size of intermediate result during evaluation of variable
 - [2] min and max have to be defined
 - [3] min and max have to be defined
 - [4] min and max have to be defined

Figure 6: Flow chart for pressure and temperature reading and software compensation.

PRESSURE COMPENSATION (SECOND ORDER OVER TEMPERATURE)

In order to optimize the accuracy over temperature range at low temperature, it is recommended to compensate the pressure non-linearity over the temperature. This can be achieved by correcting the calculated temperature, offset and sensitivity by a second-order correction factor. The second-order factors are calculated as follows:

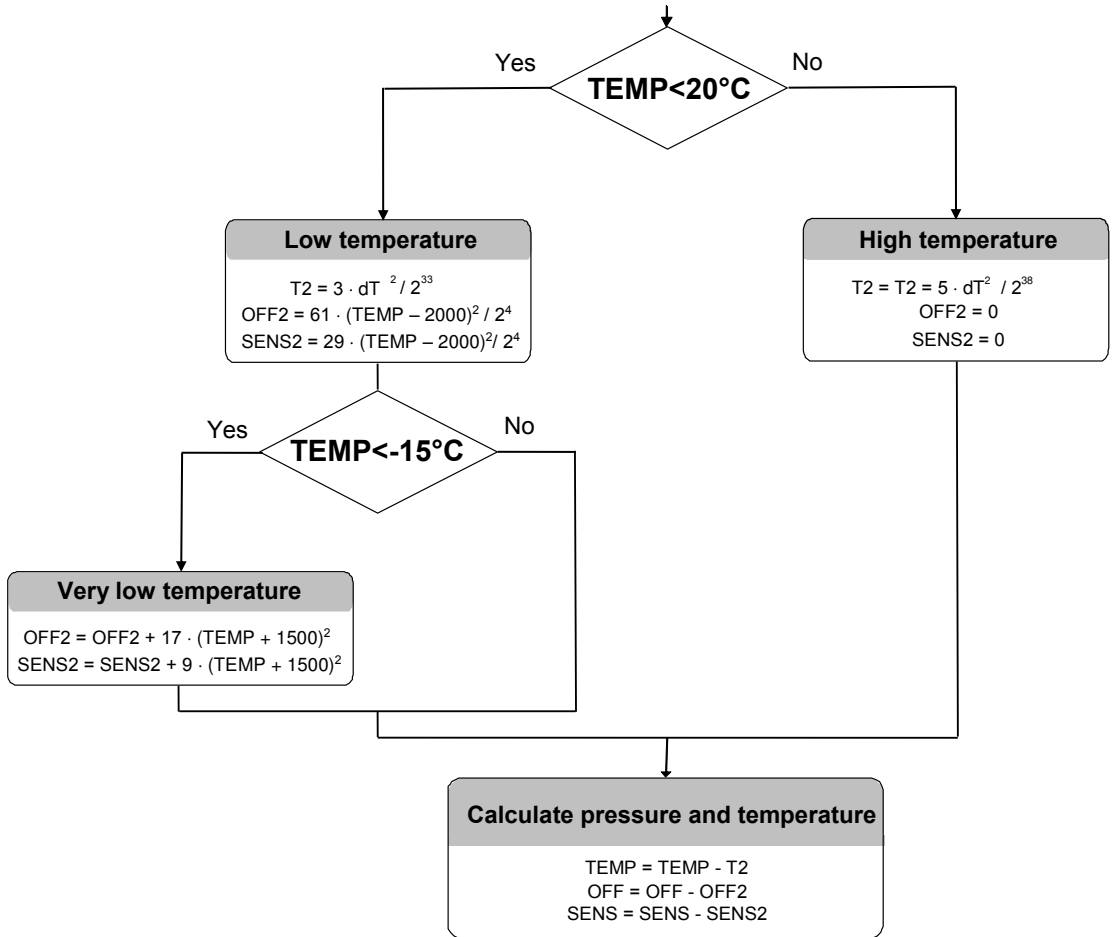
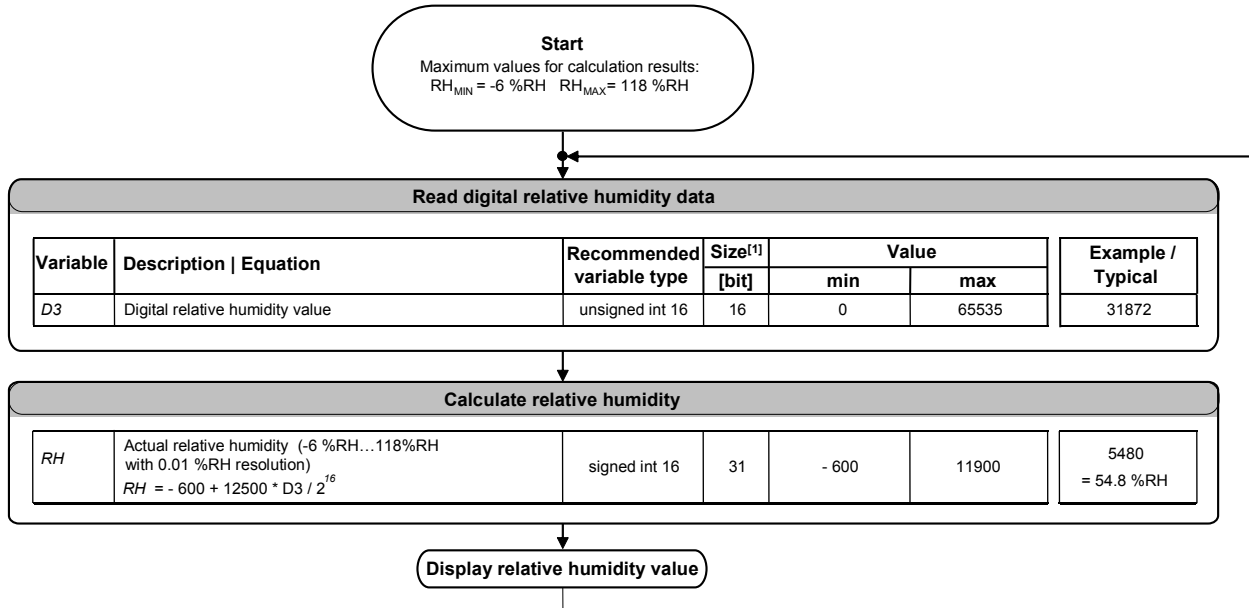

Figure 7: Flow chart for pressure and temperature to the optimum accuracy.

RELATIVE HUMIDITY CALCULATION



Notes
[1] Maximal size of intermediate result during evaluation of variable

Figure 8: Flow chart for humidity reading.

To accommodate any process variation (nominal capacitance value of the humidity sensor), tolerances of the sensor above 100%RH and below 0%RH must be considered. As a consequence:

- 118%RH corresponds to 0xFF which is the maximum RH digital output that can be sent out from the ASIC. RH output can reach 118%RH and above this value, there will have a clamp of the RH output to this value.
- -6%RH corresponds to 0x00 which is the minimum RH digital output that can be sent out from the ASIC. RH output can reach -6%RH and below this value, there will have a clamp of the RH output to this value.

The relative humidity is obtained by the following formula (result in %RH):

$$RH = \left(-6 + 125 \cdot \frac{D3}{2^{16}} \right)$$

As example, the transferred 16-bit relative humidity data 0x7C80: 31872 corresponds to a relative humidity of 54.8%RH.

Finally, 1st order temperature compensation is computed for optimal accuracy over [0...+85°C] temperature range. The final compensated relative humidity value $RH_{compensated}$ is calculated as:

$$RH_{compensated} = RH + (20 - TEMP) \cdot T_{coeff}$$

$TEMP$ Temperature calculated on p.9 unit [°C]

T_{coeff} Temperature correction coefficient unit [%RH / °C]

Optimal relative humidity accuracy over [0...+85°C] temperature range is obtained with $T_{coeff} = -0.18$

APPLICATION CIRCUIT

The MS8607 is a circuit that can be used in conjunction with a microcontroller by I2C protocol interface. It is designed for low-voltage systems with a supply voltage of 3 V and can be used in industrial pressure / humidity / temperature applications.

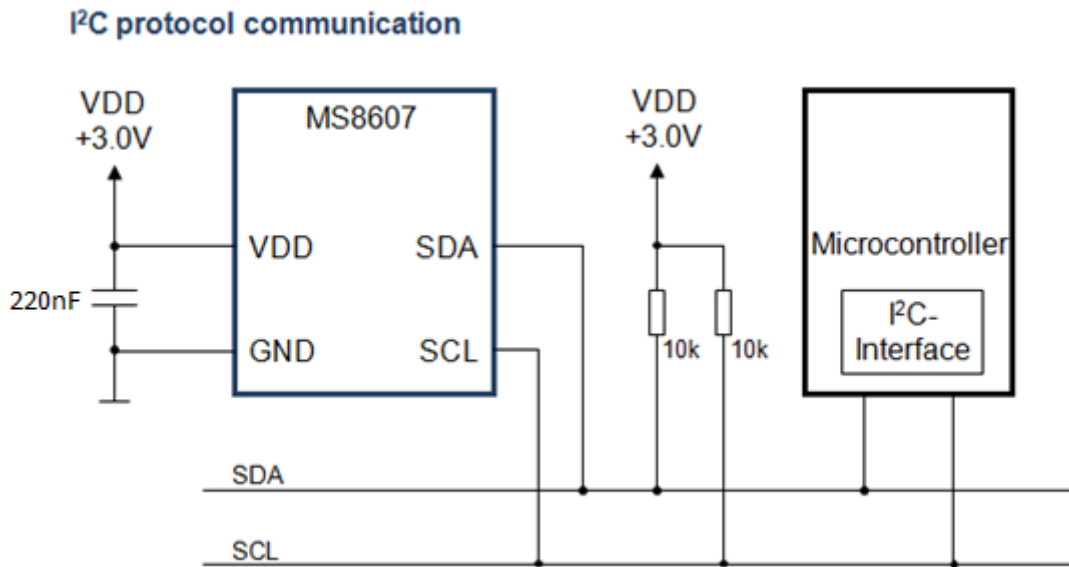

Figure 9: Typical application circuit

I²C INTERFACE: PRESSURE AND TEMPERATURE

COMMANDS

Each I²C communication message starts with the start condition and it is ended with the stop condition. The I²C address for pressure and temperature sensing is 1110110. The description of the commands related to pressure and temperature sensing is detailed on p. 5.

RESET SEQUENCE

The Reset sequence shall be sent once after power-on to make sure that the calibration PROM gets loaded into the internal register. It can be also used to reset the device PROM from an unknown condition.

The reset can be sent at any time. In the event that there is not a successful power on reset this may be caused by the SDA being blocked by the module in the acknowledge state. The only way to get the ASIC to function is to send several SCLs followed by a reset sequence or to repeat power on reset.

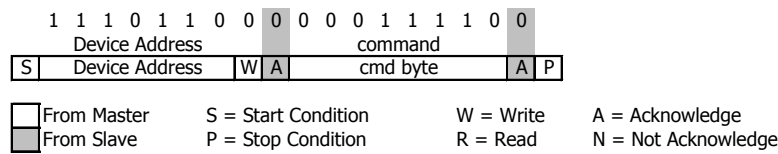

Figure 10: I²C Reset Command

PROM READ P&T SEQUENCE

The read command for PROM shall be executed once after reset by the user to read the content of the calibration PROM and to calculate the calibration coefficients. There are in total 7 addresses resulting in a total memory of 112 bit. The addresses contain factory data and the setup, calibration coefficients, the serial code and CRC (see details on p. 15, Figure 22). The command sequence is 8 bits long with a 16 bit result which is clocked with the MSB first. The PROM Read command consists of two parts. First command sets up the system into PROM read mode (Figure 11). The second part gets the data from the system (Figure 12).

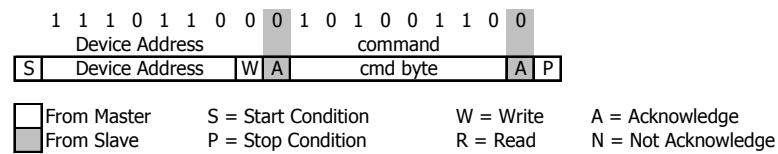

Figure 11: I²C Command to read P&T memory PROM address 0xA6

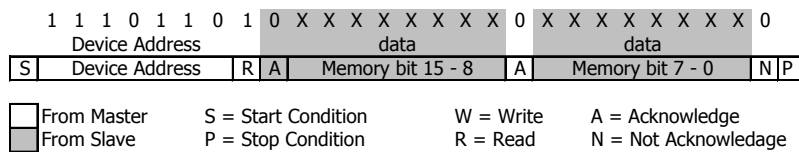

Figure 12: I²C answer from ASIC (Pressure and temperature)

CONVERSION SEQUENCE

The conversion command is used to initiate uncompensated pressure (D1) or uncompensated temperature (D2) conversion. After the conversion, using ADC read command the result is clocked out with the MSB first. If the conversion is not executed before the ADC read command, or the ADC read command is repeated, it will give 0 as the output result. If the ADC read command is sent during conversion the result will be 0, the conversion will not stop and the final result will be wrong. Conversion sequence sent during the already started conversion process will yield incorrect result as well. A conversion can be started by sending the command to the ASIC. When the command is sent to the system it stays busy until conversion is done. When conversion is finished, the data can be accessed by sending a Read command. When the Acknowledge bit is sent from the ASIC, 24 SCL cycles may be sent to receive all result bits. Every 8 bits the system waits for the Acknowledge bit.

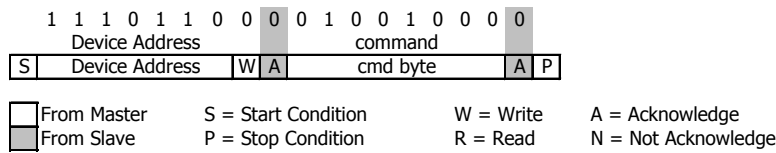

Figure 13: I²C command to initiate a pressure conversion (OSR=4096, typ=D1)

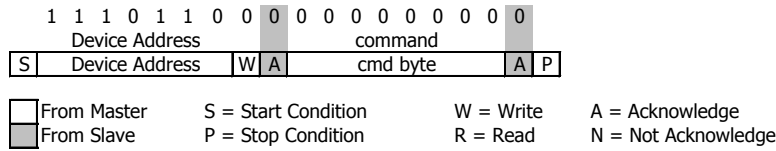

Figure 14: I²C ADC read sequence

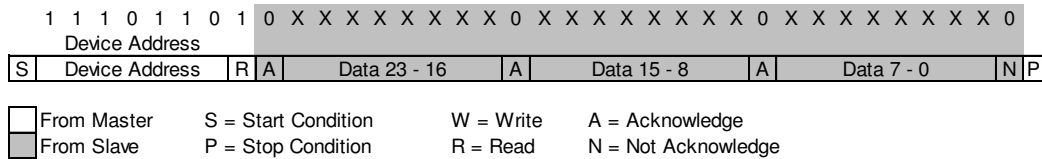

Figure 15: I²C answer from the ASIC

I²C INTERFACE: RELATIVE HUMIDITY

COMMANDS

Each I2C communication message starts with the start condition and it is ended with the stop condition. The I2C address for humidity sensing is 1000000. The description of the commands related to humidity sensing is detailed on p. 6.

RESET SEQUENCE

This command is used for rebooting the humidity sensor by switching the power off and on again. Upon reception of this command, the humidity sensor system reinitializes and starts operation according to the default settings with the exception of the heater bit in the user register. The reset takes less than 15ms.

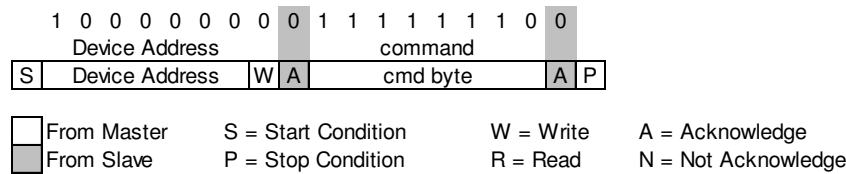

Figure 16: I²C Reset Command

READ AND WRITE USER REGISTER SEQUENCE

The following sequence illustrates how to read and write the user register. First, it reads the content of the user register. Then it writes the user register for configuring the humidity sensor to 8 bits measurement resolution from the default configuration.

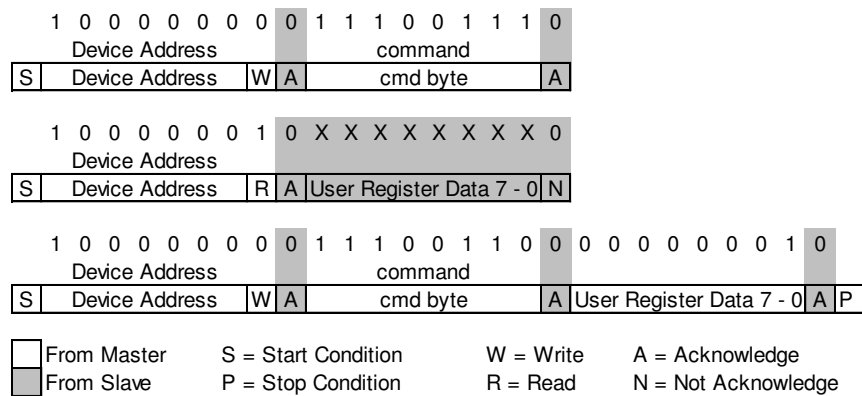

Figure 17: I²C read and write user register commands

MEASURE RH HOLD/NO HOLD SEQUENCE

MS8607 has two different operation modes to measure relative humidity (RH): Hold Master mode and No Hold Master mode.

No Hold Master mode allows for processing other I²C communication tasks on a bus while the humidity sensor is measuring. Figure 18 and 19 illustrate the communication sequence of both modes. In the Hold Master mode, the humidity sensor pulls down the SCK line while measuring to force the master into a wait state. By releasing the SCK line, the humidity sensor indicates that internal processing is completed and that transmission may be continued.

In the No Hold Master mode, the MCU has to poll for the termination of the internal processing of the humidity sensor. This is done by sending a start condition followed by the I²C header (0x81) as shown below. If the internal processing is finished, the humidity sensor acknowledges the poll of the MCU and data can be read by the MCU. If the measurement processing is not finished, the humidity sensor answers the Not Acknowledge bit and start condition must be issued once more.

For both modes, the measurement is stored into 14 bits. The two remaining least significant bits (LSBs) are used for transmitting status information. Bit1 of the two LSBs must be set to '1'. Bit0 is currently not assigned.

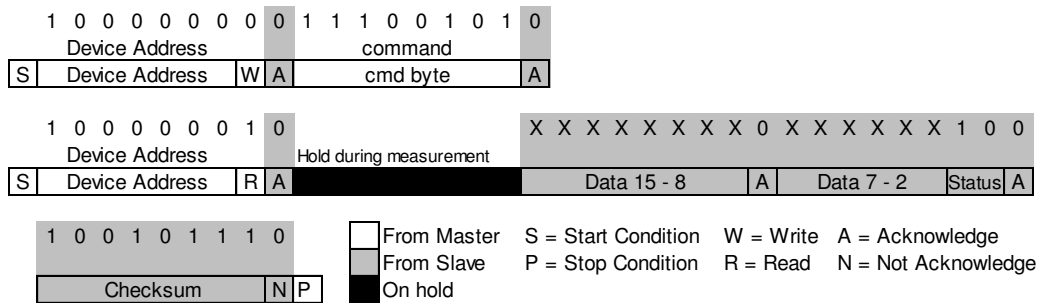

Figure 18: I²C Measure RH Hold Master communication sequence

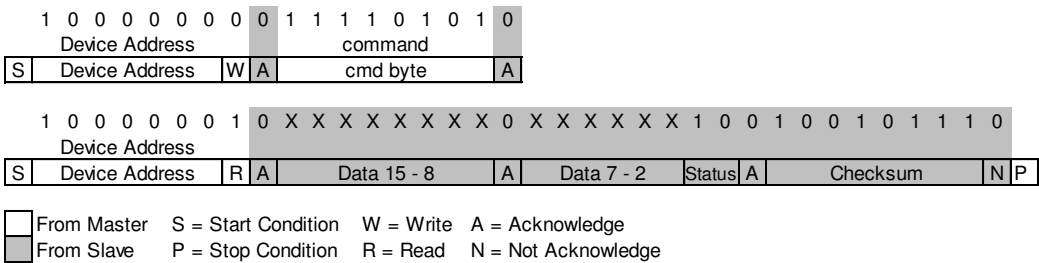

Figure 19: I²C Measure RH No Hold Master communication sequence

For Hold Master sequence, the Acknowledge bit that follows the Status bit may be changed to Not Acknowledge bit followed by a stop condition to omit checksum transmission.

For No Hold Master sequence, if measurement is not completed upon “read” command, sensor does not provide ACK on bit 27 (more of these iterations are possible). If bit 45 is changed to NACK followed by stop condition, checksum transmission is omitted.

Regarding the calculation of the relative humidity value, the Status bits must be set to '0'. Refer to "Conversion of signal outputs" section p. 10. The maximum duration for measurement depends on the type of measurement and resolution chosen. Maximum values shall be chosen for the communication planning of the MCU.

I²C communication allows for repeated start conditions without closing prior sequence with stop condition.

PROM READ RH SEQUENCE

The RH PROM memory contains 7 addresses resulting in a total memory of 112 bit. The addresses contain factory defined data and CRC (see details on p. 17, Figure 23). The command sequence is 8 bits long with a 16 bit result which is clocked with the MSB first. The RH PROM Read command consists of two parts. First command sets up the system into PROM read mode (Figure 20). The second part gets the data from the system (Figure 21).

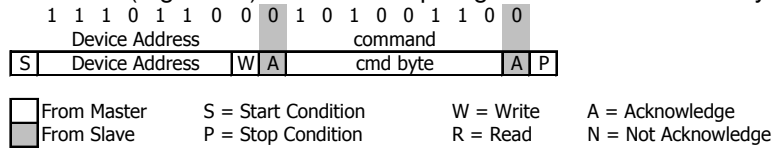

Figure 20: I²C Command to read memory address 0xA6

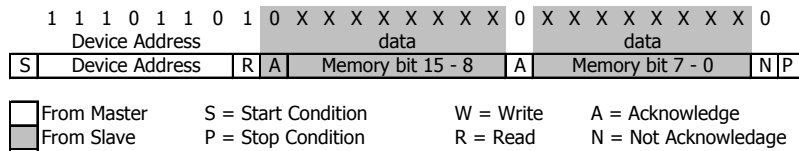

Figure 21: I²C answer from ASIC (Pressure and temperature)

CYCLIC REDUNDANCY CHECK (CRC)

MS8607 contains two separate PROM memories with identical size (112-Bit): one for pressure and temperature P&T (Figure 22), the other for relative humidity RH (Figure 23). Each PROM memory can be accessed using the I²C commands PROM Read P&T and PROM Read RH (p. 6).

Address (Hex.)	Bit 15	Bit 14	Bit 13	Bit 12	Bit 11	Bit 10	Bit 9	Bit 8	Bit 7	Bit 6	Bit 5	Bit 4	Bit 3	Bit 2	Bit 1	Bit 0
0xA0	CRC				Factory defined											
0xA2													C1			
0xA4													C2			
0xA6													C3			
0xA8													C4			
0xAA													C5			
0xAC													C6			

Figure 22: P&T Memory PROM mapping for pressure and temperature

	Bit 14	Bit 13	Bit 12	Bit 11	Bit 10	Bit 9	Bit 8	Bit 7	Bit 6	Bit 5	Bit 4	Bit 3	Bit 2	Bit 1	Bit 0	
Address (Hex.)	Bit 15	Bit 14	Bit 13	Bit 12	Bit 11	Bit 10	Bit 9	Bit 8	Bit 7	Bit 6	Bit 5	Bit 4	Bit 3	Bit 2	Bit 1	Bit 0
0xA0	Factory defined															
0xA2	Factory defined															
0xA4	Factory defined															
0xA6	Factory defined															
0xA8	Factory defined															
0xAA	Factory defined															
0xAC	Factory defined												CRC			

Figure 23: RH Memory PROM mapping for relative humidity

A 4-bit CRC has been implemented to check the data integrity in both PROM memories. The C code below describes the CRC calculation for P&T Memory PROM and for RH Memory PROM.

C CODE EXAMPLE FOR CRC-4 CALCULATION (P&T MEMORY PROM)

```

unsigned char crc4_PT(unsigned int n_prom[])           // n_prom defined as 8x unsigned int (n_prom[8])
{
int cnt;                                           // simple counter
unsigned int n_rem=0;                             // crc remainder
unsigned char n_bit;

n_prom[0]=((n_prom[0]) & 0xFFFF);                // CRC byte is replaced by 0
n_prom[7]=0;                                     // Subsidiary value, set to 0
for (cnt = 0; cnt < 16; cnt++)                   // operation is performed on bytes
{
if (cnt%2==1)      n_rem ^= (unsigned short) ((n_prom[cnt>>1]) & 0x00FF); // choose LSB or MSB
else               n_rem ^= (unsigned short) (n_prom[cnt>>1]>>8);
for (n_bit = 8; n_bit > 0; n_bit--)
{
if (n_rem & (0x8000))      n_rem = (n_rem << 1) ^ 0x3000;
else                       n_rem = (n_rem << 1);
}
}
n_rem= ((n_rem >> 12) & 0x000F);                // final 4-bit remainder is CRC code
return (n_rem ^ 0x00);
}

```

C CODE EXAMPLE FOR CRC-4 CALCULATION (RH MEMORY PROM)

```

unsigned char crc4_RH(unsigned int n_prom[])       // n_prom defined as 8x unsigned int (n_prom[8])
{
int cnt;                                           // simple counter
unsigned int n_rem=0;                             // crc remainder
unsigned char n_bit;

n_prom[6]=((n_prom[6]) & 0xFFFF);                // CRC byte is replaced by 0
n_prom[7]=0;                                     // Subsidiary value, set to 0
for (cnt = 0; cnt < 16; cnt++)                   // operation is performed on bytes
{
if (cnt%2==1)      n_rem ^= (unsigned short) ((n_prom[cnt>>1]) & 0x00FF); // choose LSB or MSB
else               n_rem ^= (unsigned short) (n_prom[cnt>>1]>>8);
for (n_bit = 8; n_bit > 0; n_bit--)
{
if (n_rem & (0x8000))      n_rem = (n_rem << 1) ^ 0x3000;
}
}
}

```

RECOMMENDED PAD LAYOUT

Pad layout for bottom side of the MS8607-02BA01 soldered onto printed circuit board.

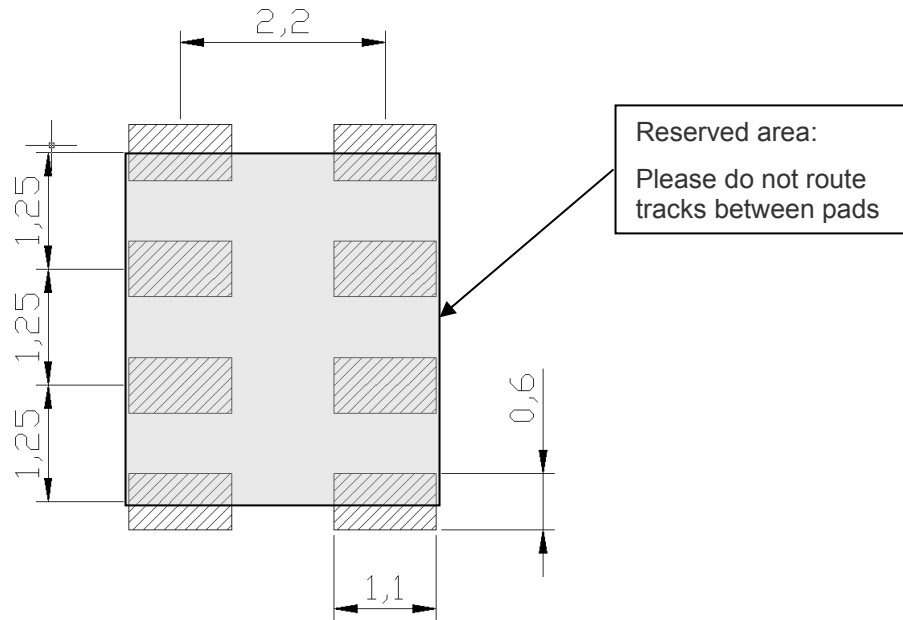

SHIPPING PACKAGE

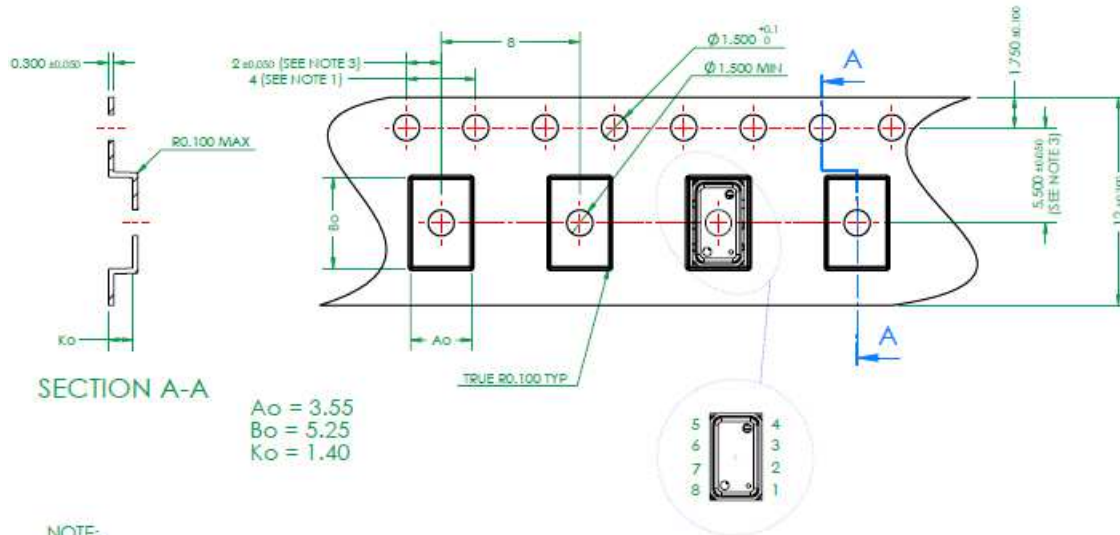

SECTION A-A

Ao = 3.55
Bo = 5.25
Ko = 1.40

NOTE:

- 1: TO SPROCKET HOLE PITCH CUMULATIVE TOLERANCE ± 0.2
- 2: CAMBER IN COMPLIANCE WITH EIA 481
- 3: POCKET POSITION RELATIVE TO SPROCKET HOLE
MEASURED AS TRUE POSITION OF POCKET, NOT POCKET HOLE

MOUNTING AND ASSEMBLY CONSIDERATIONS

SOLDERING

Please refer to the application note AN808 available on our website for all soldering issues.

MOUNTING

The MS8607 can be placed with automatic Pick & Place equipment using vacuum nozzles. It will not be damaged by the vacuum. Due to the low stress assembly the sensor does not show pressure hysteresis effects. It is important to solder all contact pads.

CONNECTION TO PCB

The package outline of the module allows the use of a flexible PCB for interconnection. This can be important for applications in watches and other special devices.

CLEANING

The MS8607 has been manufactured under cleanroom conditions. It is therefore recommended to assemble the sensor under class 10'000 or better conditions. Should this not be possible, it is recommended to protect the sensor opening during assembly from entering particles and dust. To avoid cleaning of the PCB, solder paste of type "no-clean" shall be used. Cleaning might damage the sensor!

ESD PRECAUTIONS

The electrical contact pads are protected against ESD up to 2 kV HBM (human body model). It is therefore essential to ground machines and personnel properly during assembly and handling of the device. The MS8607 is shipped in antistatic transport boxes. Any test adapters or production transport boxes used during the assembly of the sensor shall be of an equivalent antistatic material.

DECOUPLING CAPACITOR

Particular care must be taken when connecting the device to the power supply. A minimum 220nF ceramic capacitor must be placed as close as possible to the MS8607 VDD pin. This capacitor will stabilize the power supply during data conversion and thus, provide the highest possible accuracy.

MS8607-02BA01

PHT Combination Sensor

ORDERING INFORMATION

Part Number / Art. Number	Product	Delivery Form
MS860702BA01-50	PHT Combination Sensor Module 5x3mm	Tape & Reel

NORTH AMERICA

Tel: 800-522-6752
Email: customercare.frmt@te.com

EUROPE

Tel: +31 73 624 6999
Email: customercare.bevx@te.com

ASIA

Tel: +86 0400 820 6015
Email: customercare.shzn@te.com

TE.com/sensorsolutions

Measurement Specialties (MEAS), TE Connectivity, TE Connectivity (logo) and EVERY CONNECTION COUNTS are trademarks. All other logos, products and/or company names referred to herein might be trademarks of their respective owners. The information given herein, including drawings, illustrations and schematics which are intended for illustration purposes only, is believed to be reliable. However, TE Connectivity makes no warranties as to its accuracy or completeness and disclaims any liability in connection with its use. TE Connectivity's obligations shall only be as set forth in TE Connectivity's Standard Terms and Conditions of Sale for this product and in no case will TE Connectivity be liable for any incidental, indirect or consequential damages arising out of the sale, resale, use or misuse of the product. Users of TE Connectivity products should make their own evaluation to determine the suitability of each such product for the specific application.