

Thrust Pads • DIN 6311 and low model
22560.0116



Product Description

Combinable with grub screws DIN 6332 with thrust point EH 22540.

Material

- stainless steel

Assembly

The thrust pad is to be held the way the spring retainer lies in the recess with its open side at the bottom. The grub screw is inclined as far as possible in the direction of the open side of the ring and pressed in.

More information

Further products

- Grub Screws, DIN 6332 with thrust point

Drawing

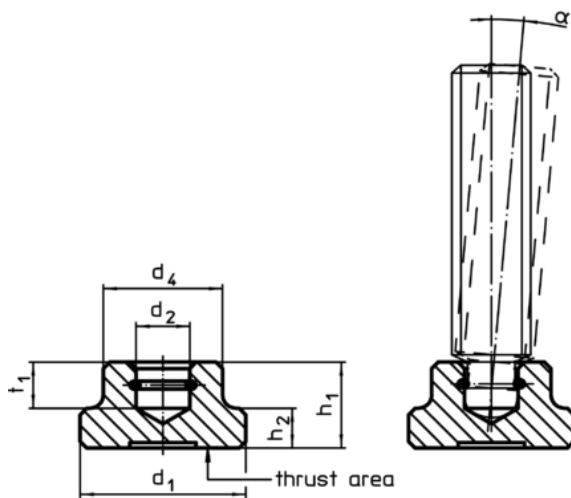

picture 1

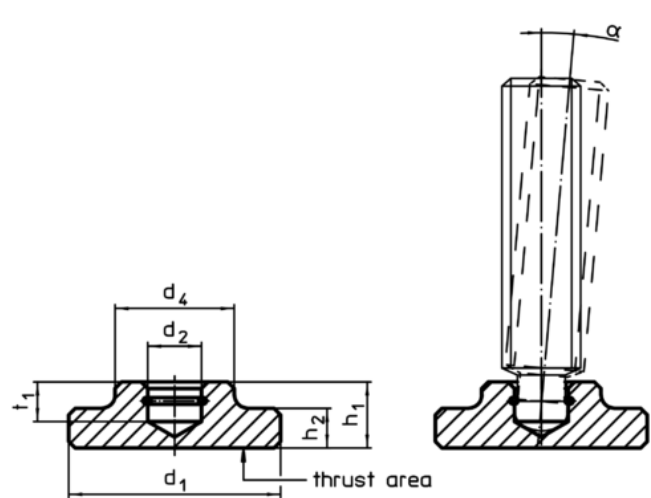

picture 2

Order information

d ₁	d ₂ H12	Dimensions				t ₁	For grub screws with thrust point DIN 6332 [mm]	α min.	 [g]	Art. No.
		d ₄	h ₁	h ₂	[mm]					
DIN 6311 with snap ring, form S – picture 1, stainless steel										
16	6.1	12	9	4	5	M8	4°	39	22560.0116	

Application example



Compliance

RoHS compliant

Compliant according to Directive 2011/65/EU and Directive 2015/863

Does not contain SVHC substances

No SVHC substances with more than 0.1% w/w contained - SVHC list [REACH] as of 10.06.2022

Does not contain Proposition 65 substances

No Proposition 65 substances included
<https://www.P65Warnings.ca.gov/>

Free from Conflict Minerals

This product does not contain any substances designated as "conflict minerals" such as tantalum, tin, gold or tungsten from the Democratic Republic of Congo or adjacent countries.