

Chip Coils for High Frequency Horizontal Wire Wound

LQW18A_00 Series (0603 Size)

Dimension

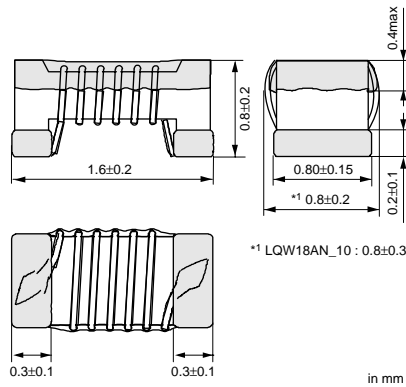

Packaging

Code	Packaging	Minimum Quantity
D	180mm Paper Tape	4000
J	330mm Paper Tape	10000
B	Bulk(Bag)	500

Rated Value (□: packaging code)

Part Number	Inductance	Test Frequency	Rated Current	Max. of DC resistance	Q (min.)	Test Frequency	Self Resonance Frequency (min.)
LQW18AN2N2D00□	2.2nH±0.5nH	100MHz	700mA	0.049ohm	16	250MHz	6000MHz
LQW18AN3N6C00□	3.6nH±0.2nH	100MHz	850mA	0.059ohm	25	250MHz	6000MHz
LQW18AN3N6D00□	3.6nH±0.5nH	100MHz	850mA	0.059ohm	25	250MHz	6000MHz
LQW18AN3N9C00□	3.9nH±0.2nH	100MHz	850mA	0.059ohm	35	250MHz	6000MHz
LQW18AN3N9D00□	3.9nH±0.5nH	100MHz	850mA	0.059ohm	35	250MHz	6000MHz
LQW18AN4N3C00□	4.3nH±0.2nH	100MHz	850mA	0.059ohm	35	250MHz	6000MHz
LQW18AN4N3D00□	4.3nH±0.5nH	100MHz	850mA	0.059ohm	35	250MHz	6000MHz
LQW18AN4N7D00□	4.7nH±0.5nH	100MHz	850mA	0.059ohm	35	250MHz	6000MHz
LQW18AN5N6C00□	5.6nH±0.2nH	100MHz	750mA	0.082ohm	35	250MHz	6000MHz
LQW18AN5N6D00□	5.6nH±0.5nH	100MHz	750mA	0.082ohm	35	250MHz	6000MHz
LQW18AN6N2C00□	6.2nH±0.2nH	100MHz	750mA	0.082ohm	35	250MHz	6000MHz
LQW18AN6N2D00□	6.2nH±0.5nH	100MHz	750mA	0.082ohm	35	250MHz	6000MHz
LQW18AN6N8C00□	6.8nH±0.2nH	100MHz	750mA	0.082ohm	35	250MHz	6000MHz
LQW18AN6N8D00□	6.8nH±0.5nH	100MHz	750mA	0.082ohm	35	250MHz	6000MHz
LQW18AN7N5D00□	7.5nH±0.5nH	100MHz	750mA	0.082ohm	35	250MHz	6000MHz
LQW18AN8N2D00□	8.2nH±0.5nH	100MHz	650mA	0.11ohm	35	250MHz	6000MHz
LQW18AN8N7D00□	8.7nH±0.5nH	100MHz	650mA	0.11ohm	35	250MHz	6000MHz
LQW18AN9N1D00□	9.1nH±0.5nH	100MHz	650mA	0.11ohm	35	250MHz	6000MHz
LQW18AN9N5D00□	9.5nH±0.5nH	100MHz	650mA	0.11ohm	35	250MHz	6000MHz
LQW18AN10NG00□	10nH±2%	100MHz	650mA	0.11ohm	35	250MHz	6000MHz
LQW18AN10NJ00□	10nH±5%	100MHz	650mA	0.11ohm	35	250MHz	6000MHz
LQW18AN11NG00□	11nH±2%	100MHz	650mA	0.11ohm	35	250MHz	6000MHz
LQW18AN11NJ00□	11nH±5%	100MHz	650mA	0.11ohm	35	250MHz	6000MHz

Operating Temperature Range: -55°C to +125°C

Only for reflow soldering.

Continued on the following page.

● This data sheet is applied for CHIP COIL used for General Electronics equipment for your design.

Note:

- This datasheet is downloaded from the website of Murata Manufacturing co., ltd. Therefore, it's specifications are subject to change or our products in it may be discontinued without advance notice. Please check with our sales representatives or product engineers before ordering.
- This datasheet has only typical specifications because there is no space for detailed specifications. Therefore, please approve our product specifications or transact the approval sheet for product specifications before ordering.

 Continued from the preceding page.

Part Number	Inductance	Test Frequency	Rated Current	Max. of DC resistance	Q (min.)	Test Frequency	Self Resonance Frequency (min.)
LQW18AN12NG00□	12nH±2%	100MHz	600mA	0.13ohm	35	250MHz	6000MHz
LQW18AN12NJ00□	12nH±5%	100MHz	600mA	0.13ohm	35	250MHz	6000MHz
LQW18AN13NG00□	13nH±2%	100MHz	600mA	0.13ohm	35	250MHz	6000MHz
LQW18AN13NJ00□	13nH±5%	100MHz	600mA	0.13ohm	35	250MHz	6000MHz
LQW18AN15NG00□	15nH±2%	100MHz	600mA	0.13ohm	40	250MHz	6000MHz
LQW18AN15NJ00□	15nH±5%	100MHz	600mA	0.13ohm	40	250MHz	6000MHz
LQW18AN16NG00□	16nH±2%	100MHz	550mA	0.16ohm	40	250MHz	5500MHz
LQW18AN16NJ00□	16nH±5%	100MHz	550mA	0.16ohm	40	250MHz	5500MHz
LQW18AN18NG00□	18nH±2%	100MHz	550mA	0.16ohm	40	250MHz	5500MHz
LQW18AN18NJ00□	18nH±5%	100MHz	550mA	0.16ohm	40	250MHz	5500MHz
LQW18AN20NG00□	20nH±2%	100MHz	550mA	0.16ohm	40	250MHz	4900MHz
LQW18AN20NJ00□	20nH±5%	100MHz	550mA	0.16ohm	40	250MHz	4900MHz
LQW18AN22NG00□	22nH±2%	100MHz	500mA	0.17ohm	40	250MHz	4600MHz
LQW18AN22NJ00□	22nH±5%	100MHz	500mA	0.17ohm	40	250MHz	4600MHz
LQW18AN24NG00□	24nH±2%	100MHz	500mA	0.21ohm	40	250MHz	3800MHz
LQW18AN24NJ00□	24nH±5%	100MHz	500mA	0.21ohm	40	250MHz	3800MHz
LQW18AN27NG00□	27nH±2%	100MHz	440mA	0.21ohm	40	250MHz	3700MHz
LQW18AN27NJ00□	27nH±5%	100MHz	440mA	0.21ohm	40	250MHz	3700MHz
LQW18AN30NG00□	30nH±2%	100MHz	420mA	0.23ohm	40	250MHz	3300MHz
LQW18AN30NJ00□	30nH±5%	100MHz	420mA	0.23ohm	40	250MHz	3300MHz
LQW18AN33NG00□	33nH±2%	100MHz	420mA	0.23ohm	40	250MHz	3200MHz
LQW18AN33NJ00□	33nH±5%	100MHz	420mA	0.23ohm	40	250MHz	3200MHz
LQW18AN36NG00□	36nH±2%	100MHz	400mA	0.26ohm	40	250MHz	2900MHz
LQW18AN36NJ00□	36nH±5%	100MHz	400mA	0.26ohm	40	250MHz	2900MHz
LQW18AN39NG00□	39nH±2%	100MHz	400mA	0.26ohm	40	250MHz	2800MHz
LQW18AN39NJ00□	39nH±5%	100MHz	400mA	0.26ohm	40	250MHz	2800MHz
LQW18AN43NG00□	43nH±2%	100MHz	380mA	0.29ohm	40	200MHz	2700MHz
LQW18AN43NJ00□	43nH±5%	100MHz	380mA	0.29ohm	40	200MHz	2700MHz
LQW18AN47NG00□	47nH±2%	100MHz	380mA	0.29ohm	38	200MHz	2600MHz
LQW18AN47NJ00□	47nH±5%	100MHz	380mA	0.29ohm	38	200MHz	2600MHz
LQW18AN51NG00□	51nH±2%	100MHz	370mA	0.33ohm	38	200MHz	2500MHz
LQW18AN51NJ00□	51nH±5%	100MHz	370mA	0.33ohm	38	200MHz	2500MHz
LQW18AN56NG00□	56nH±2%	100MHz	360mA	0.35ohm	38	200MHz	2400MHz
LQW18AN56NJ00□	56nH±5%	100MHz	360mA	0.35ohm	38	200MHz	2400MHz
LQW18AN62NG00□	62nH±2%	100MHz	280mA	0.51ohm	38	200MHz	2300MHz
LQW18AN62NJ00□	62nH±5%	100MHz	280mA	0.51ohm	38	200MHz	2300MHz
LQW18AN68NG00□	68nH±2%	100MHz	340mA	0.38ohm	38	200MHz	2200MHz
LQW18AN68NJ00□	68nH±5%	100MHz	340mA	0.38ohm	38	200MHz	2200MHz
LQW18AN72NG00□	72nH±2%	100MHz	270mA	0.56ohm	34	150MHz	2100MHz
LQW18AN72NJ00□	72nH±5%	100MHz	270mA	0.56ohm	34	150MHz	2100MHz
LQW18AN75NG00□	75nH±2%	100MHz	270mA	0.56ohm	34	150MHz	2050MHz

Operating Temperature Range: -55°C to +125°C
Only for reflow soldering.

Continued on the following page. 

● This data sheet is applied for CHIP COIL used for General Electronics equipment for your design.

Note:

1. This datasheet is downloaded from the website of Murata Manufacturing co., Ltd. Therefore, it's specifications are subject to change or our products in it may be discontinued without advance notice. Please check with our sales representatives or product engineers before ordering.
2. This datasheet has only typical specifications because there is no space for detailed specifications. Therefore, please approve our product specifications or transact the approval sheet for product specifications before ordering.

 Continued from the preceding page.

Part Number	Inductance	Test Frequency	Rated Current	Max. of DC resistance	Q (min.)	Test Frequency	Self Resonance Frequency (min.)
LQW18AN75NJ00□	75nH±5%	100MHz	270mA	0.56ohm	34	150MHz	2050MHz
LQW18AN82NG00□	82nH±2%	100MHz	250mA	0.60ohm	34	150MHz	2000MHz
LQW18AN82NJ00□	82nH±5%	100MHz	250mA	0.60ohm	34	150MHz	2000MHz
LQW18AN91NG00□	91nH±2%	100MHz	230mA	0.64ohm	34	150MHz	1900MHz
LQW18AN91NJ00□	91nH±5%	100MHz	230mA	0.64ohm	34	150MHz	1900MHz
LQW18ANR10G00□	100nH±2%	100MHz	220mA	0.68ohm	34	150MHz	1800MHz
LQW18ANR10J00□	100nH±5%	100MHz	220mA	0.68ohm	34	150MHz	1800MHz
LQW18ANR11G00□	110nH±2%	100MHz	200mA	1.2ohm	32	150MHz	1350MHz
LQW18ANR11J00□	110nH±5%	100MHz	200mA	1.2ohm	32	150MHz	1350MHz
LQW18ANR12G00□	120nH±2%	100MHz	180mA	1.3ohm	32	150MHz	1600MHz
LQW18ANR12J00□	120nH±5%	100MHz	180mA	1.3ohm	32	150MHz	1600MHz
LQW18ANR13G00□	130nH±2%	100MHz	170mA	1.4ohm	32	150MHz	1450MHz
LQW18ANR13J00□	130nH±5%	100MHz	170mA	1.4ohm	32	150MHz	1450MHz
LQW18ANR15G00□	150nH±2%	100MHz	160mA	1.5ohm	32	150MHz	1400MHz
LQW18ANR15J00□	150nH±5%	100MHz	160mA	1.5ohm	32	150MHz	1400MHz
LQW18ANR16G00□	160nH±2%	100MHz	150mA	2.1ohm	32	150MHz	1350MHz
LQW18ANR16J00□	160nH±5%	100MHz	150mA	2.1ohm	32	150MHz	1350MHz
LQW18ANR18G00□	180nH±2%	100MHz	140mA	2.2ohm	25	100MHz	1300MHz
LQW18ANR18J00□	180nH±5%	100MHz	140mA	2.2ohm	25	100MHz	1300MHz
LQW18ANR20G00□	200nH±2%	100MHz	120mA	2.4ohm	25	100MHz	1250MHz
LQW18ANR20J00□	200nH±5%	100MHz	120mA	2.4ohm	25	100MHz	1250MHz
LQW18ANR22G00□	220nH±2%	100MHz	120mA	2.5ohm	25	100MHz	1200MHz
LQW18ANR22J00□	220nH±5%	100MHz	120mA	2.5ohm	25	100MHz	1200MHz
LQW18ANR27G00□	270nH±2%	100MHz	110mA	3.4ohm	30	100MHz	960MHz
LQW18ANR27J00□	270nH±5%	100MHz	110mA	3.4ohm	30	100MHz	960MHz
LQW18ANR33G00□	330nH±2%	100MHz	85mA	5.5ohm	30	100MHz	800MHz
LQW18ANR33J00□	330nH±5%	100MHz	85mA	5.5ohm	30	100MHz	800MHz
LQW18ANR39G00□	390nH±2%	100MHz	80mA	6.2ohm	30	100MHz	800MHz
LQW18ANR39J00□	390nH±5%	100MHz	80mA	6.2ohm	30	100MHz	800MHz
LQW18ANR47G00□	470nH±2%	100MHz	75mA	7.0ohm	30	100MHz	700MHz
LQW18ANR47J00□	470nH±5%	100MHz	75mA	7.0ohm	30	100MHz	700MHz

Operating Temperature Range: -55°C to +125°C

Only for reflow soldering.

Continued on the following page. 

● This data sheet is applied for CHIP COIL used for General Electronics equipment for your design.

 **Note:**

1. This datasheet is downloaded from the website of Murata Manufacturing co., Ltd. Therefore, it's specifications are subject to change or our products in it may be discontinued without advance notice. Please check with our sales representatives or product engineers before ordering.
2. This datasheet has only typical specifications because there is no space for detailed specifications. Therefore, please approve our product specifications or transact the approval sheet for product specifications before ordering.

Continued from the preceding page.

■ Q-Frequency Characteristics (Typ.)

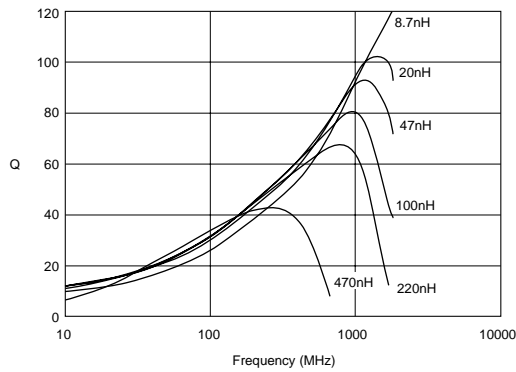

■ Inductance-Frequency Characteristics (Typ.)

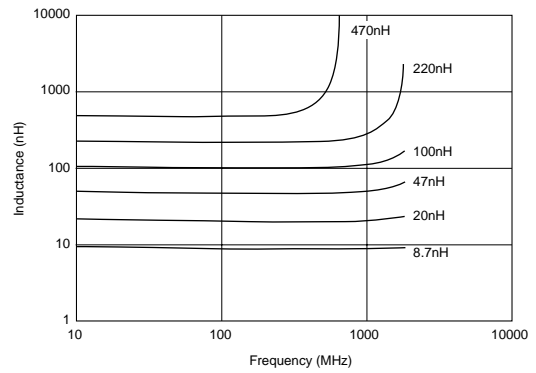

■ ⚠ Caution/Notice

⚠ Caution (Rating)

Do not use products beyond the rated current as this may create excessive heat.

Notice

Solderability of Tin plating termination chip might be deteriorated when low temperature soldering profile where peak solder temperature is below the Tin melting point is used. Please confirm the solderability of Tin plating termination chip before use.

● This data sheet is applied for CHIP COIL used for General Electronics equipment for your design.

⚠ Note:

1. This datasheet is downloaded from the website of Murata Manufacturing co., Ltd. Therefore, it's specifications are subject to change or our products in it may be discontinued without advance notice. Please check with our sales representatives or product engineers before ordering.
2. This datasheet has only typical specifications because there is no space for detailed specifications. Therefore, please approve our product specifications or transact the approval sheet for product specifications before ordering.