

# LA8N Series

## DIN W48×H24mm, Indication only, LCD counter

### ■ Features

- Upgraded features  
Voltage input and backlight model, subtraction and decimal point setting functions
- No additional power due to internal battery
- Singal input method: No-voltage input, voltage input, free voltage input
- Screw terminal type(attaching terminal cover)
- LCD display
- IP66 protection structure

Upgrade



⚠ Please read "Caution for your safety" in operation manual before using.



### ■ Ordering information

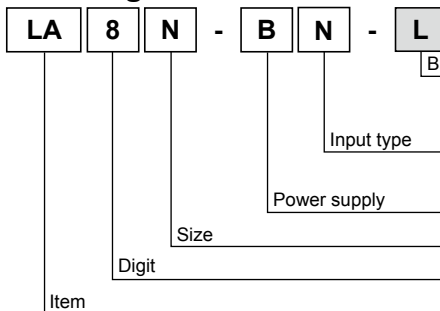

※A shaded (□) part is upgraded or added function.

No mark	None
L	Backlight function
N	No-voltage(Small signal) input
V	voltage input
F	Free voltage input
B	Internal lithium battery
N	DIN W48×H24mm
8	99999999(8digit)
LA	LCD Counter

### ■ Specifications

Model	LA8N-BN	LA8N-BN-L	LA8N-BV	LA8N-BV-L	LA8N-BF
Digit	8digit(Count up, down: -9999999 to 99999999 / Count up mode: 0 to 99999999)				
Digit size	W3.4 × H8.7mm				
Display method	LCD Zero Blanking type(Character height size: 8.7mm)				
Operation method	Count up, down mode	Count up mode	Count up, down mode	Count up mode	Count up mode
Power supply	Built-in battery				
Battery life cycle	Approx. over 7 years at 20°C				
Backlight power supply	-	24VDC±10%	-	24VDC±10%	-
Input method	No-voltage input		Voltage input		Free voltage input
Count input	Residual voltage: Max. 0.5VDC Short-circuit impedance: Max. 10kΩ Open-circuit impedance: Min. 750kΩ		"H" level voltage: 4.5-30VDC "L" level voltage: 0-2VDC		"H" level voltage: 24-240VAC /6-240VDC "L" level voltage:0-2VAC/0-2.4VDC
RESET input	No-voltage input		Voltage input		No-voltage input
Min. signal width	UP/DOWN, RESET input: Min. 20ms	RESET input: Min. 20ms	UP/DOWN, RESET input: Min. 20ms	RESET input: Min. 20ms	RESET input: Min. 20ms
Max. counting speed	1cps / 30cps / 1kcps				
External set switch	SW1※1, SW2※2, SW3※3				
Insulation resistance	Min. 100MΩ(at 500VDC megger)				
Dielectric strength※4	2,000VAC 60Hz for 1minute				
Vibration	Mechanical	0.75mm amplitude at frequency of 10 to 55Hz(for 1 min.) in each of X, Y, Z directions for 1 hour			
	Malfunction	0.3mm amplitude at frequency of 10 to 55Hz(for 1 min.) in each of X, Y, Z directions for 10 minutes			
Shock	Mechanical	300m/s <sup>2</sup> (Approx. 30G) in each of X, Y, Z directions for 3 times			
	Malfunction	100m/s <sup>2</sup> (Approx. 10G) in each of X, Y, Z directions for 3 times			
Environment	Ambient temperature	-10 to 55°C, storage: -25 to 65°C			
	Ambient humidity	35 to 85%RH, storage: 35 to 85%RH			
Protection	IP66(When using waterproof rubber for front panel)				
Accessory	Mounting bracket, Rubber waterproof ring				
Approval	CE, C, US				
Weight※5	Approx. 96g(Approx. 50g)				

- ※1. SW1 is the front panel RESET key enable/disable set switch.      ※2. SW2 is the max. counting speed set switch.  
 ※3. SW3 is the decimal point set switch.  
 ※4. No-voltage input, voltage input: between terminals and the case / Free voltage input: between the free voltage input terminal and the RESET input terminal, between terminals and the case.  
 ※Environment resistance is rated at no freezing or condensation.  
 ※5. This weight is with packaging and the weight in parentheses is only unit weight.

# Compact LCD Counter

## ■ Connections

Input type	No-backlight	Backlight
No-voltage input type	<p>●LA8N-BN※<sup>1</sup></p>	<p>●LA8N-BN-L</p> <p>※Terminal (1, 2, 3) and (4, 5) are insulated inside.</p>
Voltage input type	<p>●LA8N-BV※<sup>1</sup></p>	<p>●LA8N-BV-L</p>
Free voltage input type	<p>●LA8N-BF</p> <p>※Terminal (1, 2) and (4, 5) are insulated inside.</p>	—

※1: Terminal 2 and 5 are connected inside. (Non-isolated)  
 ※Use reliable contacts enough to flow 5 $\mu$ A current.

## ■ Dimensions

### ● Bracket

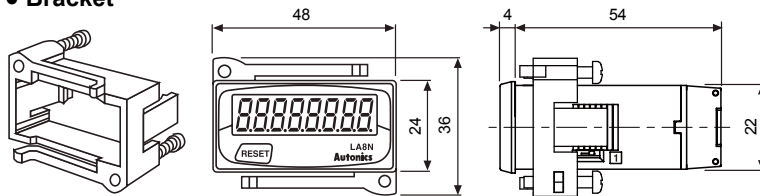

### ● Panel cut-out

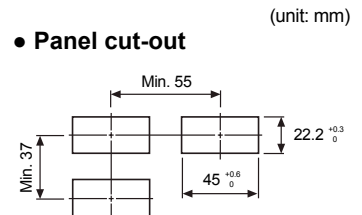

## ■ Input connections

### ○ No-voltage input (Standard sensor: NPN open collector output type sensor)

#### ● Solid-state input

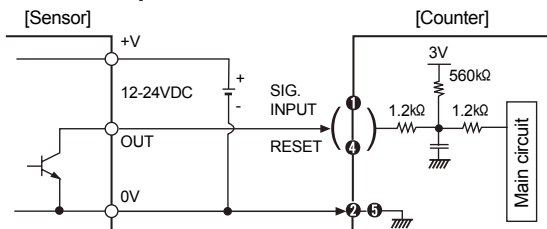

#### ● Contact input

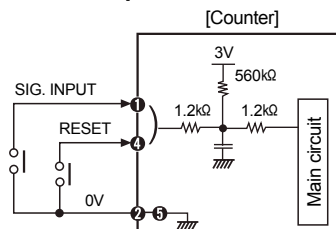

※ When power is applied to terminal No ① and ④, input terminal circuit can be broken and a malfunction can occur. (NPN output, PNP output, PNP open collector output type sensor cannot be used.)

※ ② and ⑤ are connected inside.

※ For backlight function model, the input terminals are no. ①, ③ and the GND terminal is no. ②.

※ Please use reliable contacts enough to flow 3VDC 5 $\mu$ A of current.

- (A) Photo electric sensor
- (B) Fiber optic sensor
- (C) Door/Area sensor
- (D) Proximity sensor
- (E) Pressure sensor
- (F) Rotary encoder
- (G) Connector/Socket
- (H) Temp. controller
- (I) SSR/Power controller
- (J) Counter
- (K) Timer
- (L) Panel meter
- (M) Tacho/Speed/Pulse meter
- (N) Display unit
- (O) Sensor controller
- (P) Switching power supply
- (Q) Stepping motor& Driver&Controller
- (R) Graphic/Logic panel
- (S) Field network device
- (T) Software
- (U) Other

# LA8N Series

## ○ Voltage input (Standard sensor: PNP open collector output type sensor)

### ● Solid-state input

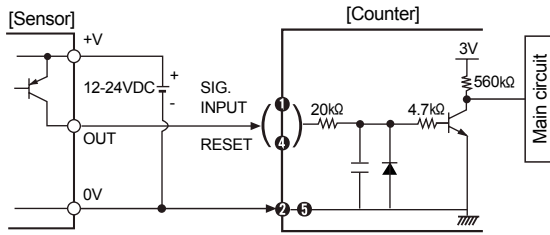

### ● Contact input

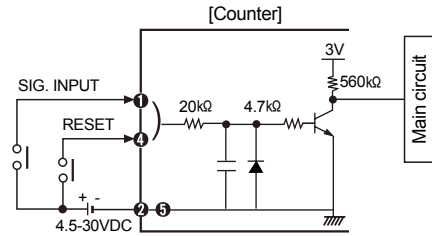

※ Please use reliable contacts enough to flow 3VDC 5 $\mu$ A of current.

※ For backlight function model, the input terminals are no. ①, ③ and the GND terminal is no. ②.

## ○ Free voltage input

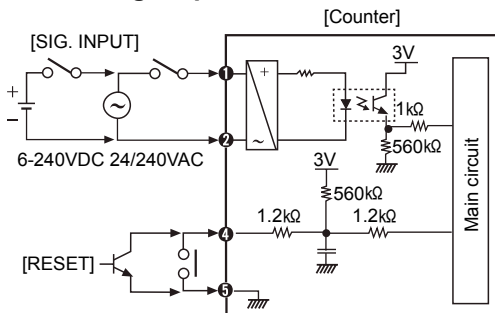

※ AC type proximity sensor cannot be used as the source of count input signals.

※ Input terminal(①, ②)and reset terminal (④, ⑤)are insulated inside.

※ It is not possible to reset with AC power or DC power.

※ When relay contact is used as the source of RESET signal, please use reliable contacts enough to flow 3VDC 5 $\mu$ A of current.

## ○ Input from AC type proximity sensor

In case of free voltage input type, do not connect AC proximity sensors instead of a switch as shown in the figure 1. It may cause malfunction due to sensor's leakage current. Connect a relay as shown in the figure 2.

(Fig. 1)

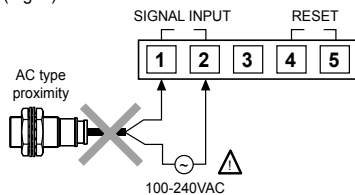

<Example of wrong connection>

(Fig. 2)

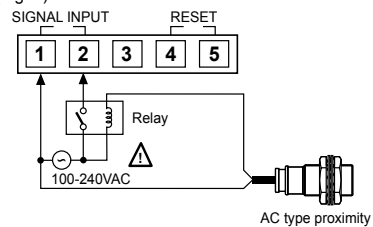

<Example of correct connection>

## ■ Set switch

### ○ SW1( ① Switch )

SW1 is a switch to Enable/Disable the front panel RESET key.

※Factory default: Enable

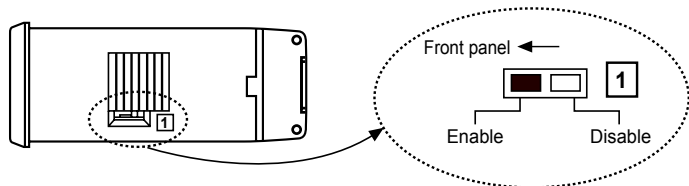

### ○ SW2( ② Switch )

SW2 is a switch for setting max. counting speed.

※Factory default: 1cps  
(Free voltage input type:  
20cps is fixed)

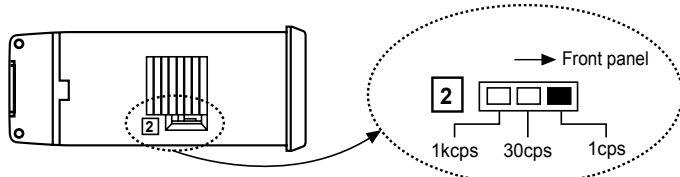

## ◎ SW3

SW3 is a switch for decimal point position. (※Factory default: No decimal point)

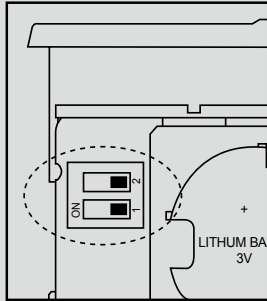

SW3	Decimal point
	Not use decimal point
	0.0
	0.00
	0.000

※Change SW3 setting after removing the case.

※Supply RESET signal (front panel or terminal RESET), after setting SW2, SW3 during operation.

## ■ Counter operation mode

### ●LA8N-BN/LA8N-BV model

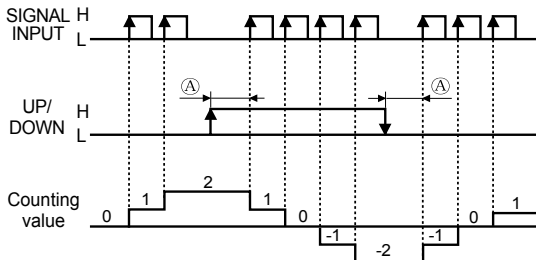

※SIGNAL INPUT: Counting input,  
UP/DOWN: Counting instruction input  
※UP/DOWN as "L" is count up (UP)  
UP/DOWN as "H" is count down (DOWN)  
※The meaning of "H" and "L"

	Voltage input	No-voltage input	Free voltage input
H	4.5-30VDC	Short	24-240VAC/6-240VDC
L	0-2VDC	Open	0-2VAC/0-2.4VDC

※(A) should be over 20ms of min. signal width. If it is below 20ms, it may cause counting error.

### ●LA8N-BN-L/LA8N-BV-L/LA8N-BF model

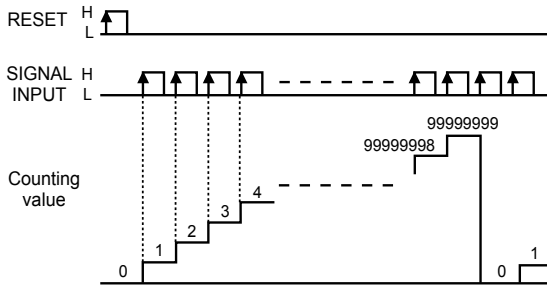

## ■ Case detachment and battery replacement

### ● Case detachment

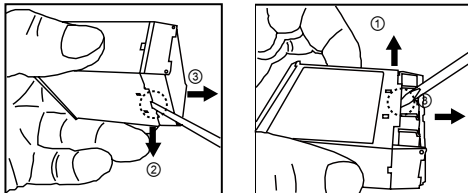

※ Hold up Lock part toward ①, ② of the product with the tool and pull toward ③ to detach the case.

⚠When using the tools, be careful not to be wounded.

### ● Battery replacement

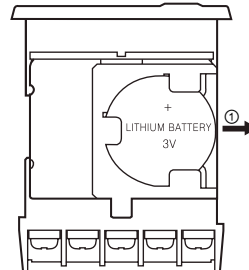

1. Detach the case.
2. Push the battery and detach it toward ①.
3. Insert a new battery with correct alignment of polarity pushing it toward opposite of ①.

※ The battery is sold separately. Please replace a battery by yourself.  
※ Do not burn up or disassemble the lithium battery.

(A) Photo electric sensor

(B) Fiber optic sensor

(C) Door/Area sensor

(D) Proximity sensor

(E) Pressure sensor

(F) Rotary encoder

(G) Connector/Socket

(H) Temp. controller

(I) SSR/Power controller

(J) Counter

(K) Timer

(L) Panel meter

(M) Tacho/Speed/Pulse meter

(N) Display unit

(O) Sensor controller

(P) Switching power supply

(Q) Stepping motor& Driver&Controller

(R) Graphic/Logic panel

(S) Field network device

(T) Software

(U) Other