

LT8609S

42V, 2A/3A Peak Micropower Synchronous Step-Down Regulator

DESCRIPTION

Demonstration circuit 2522A is a 42V, 2A/3A peak micropower synchronous step-down regulator featuring the [LT[®]8609S](#). The demo board is designed for 5V output from a 5.5V to 42V input. The wide input range allows a variety of input sources, such as automotive batteries and industrial supplies. The LT8609S is a compact, high efficiency, high speed synchronous monolithic step-down switching regulator that consumes only 2.5 μ A of quiescent current when output is regulated at 5V. Top and bottom power switches, compensation components and other necessary circuits are inside of the LT8609S to minimize external components and simplify design.

The SYNC pin on the demo board is grounded by default for low ripple Burst Mode[®] operation. Move JP1 to PULSE SKIPPING position can change the operation mode to pulse-skipping operation. Once JP1 is on SPREAD SPECTRUM position, V_{CC} is applied to the SYNC pin for low EMI spread spectrum operation. To synchronous to an

external clock, move JP1 to SYNC and apply the external clock to the SYNC turret. Figure 1 shows the efficiency of the circuit.

The demo board has an EMI filter installed. The radiated EMI performances of the board (with EMI filter) are shown in Figures 2 and 3. The red lines in Figures 2 and 3 are CISPR25 class 5 peak limit. To use the EMI filter, the input should be tied to VEMI, not V_{IN} . An inductor L2, which is a 0 Ω jumper on the board by default now, can be added in the EMI filter to further reduce the conducted emission.

The LT8609S data sheet gives a complete description of the part, operation and application information. The data sheet must be read in conjunction with this demo manual for DC2522A.

Design files for this circuit board are available at <http://www.linear.com/demo/DC2522A>

 , LT, LTC, LTM, Linear Technology, Burst Mode and the Linear logo are registered trademarks of Analog Devices, Inc. All other trademarks are the property of their respective owners.

PERFORMANCE SUMMARY Specifications are at $T_A = 25^\circ\text{C}$

| SYMBOL | PARAMETER | CONDITIONS | MIN | TYP | MAX | UNITS |
|-----------|------------------------|--------------------------------------------|------|------|------|-------|
| V_{IN} | Input Voltage Range | | 5.5 | | 42 | V |
| V_{OUT} | Output Voltage | | 4.8 | 5 | 5.2 | V |
| I_{OUT} | Maximum Output Current | | 2 | | | A |
| f_{SW} | Switching Frequency | | 1.85 | 2 | 2.15 | MHz |
| EFE | Efficiency at DC | $V_{IN} = 12\text{V}, I_{OUT} = 1\text{A}$ | | 93.1 | | % |

QUICK START PROCEDURE

DC2522A is easy to set up to evaluate the performance of the LT8609S. Refer to Figure 4 for proper measurement equipment setup and follow the procedure below:

NOTE: When measuring the input or output voltage ripple, care must be taken to avoid a long ground lead on the oscilloscope probe. See Figure 5 for the proper scope technique.

1. Set an input power supply that is capable of 42V/2A. Then turn off the supply.

2. With power off, connect the supply to the input terminals V_{IN} and GND.

3. Turn on the power at the input.

NOTE: Make sure that the input voltage never exceeds 42V.

4. Check for the proper output voltage of 5V. Turn off the power at the input.

5. Once the proper output voltage is established, connect a variable load capable of sinking 2A at 5V to the output terminals V_{OUT} and GND. Set the current for 0A.

a. If efficiency measurements are desired, an ammeter can be put in series with the output load in order to measure the DC2522A's output current.

b. A voltmeter can be placed across the output terminals in order to get an accurate output voltage measurement.

6. Turn on the power at the input.

NOTE: If there is no output, temporarily disconnect the load to make sure that the load is not set too high.

7. Once the proper output voltage is established again, adjust the load and/or input within the operating range and observe the output voltage regulation, ripple voltage, efficiency and other desired parameters.

8. An external clock can be added to the SYNC terminal when SYNC function is used (JP1 on the SYNC position). Please ensure that the chosen RT sets the LT8609S switching frequency to equal or below the lowest SYNC frequency. See the data sheet section, Synchronization.

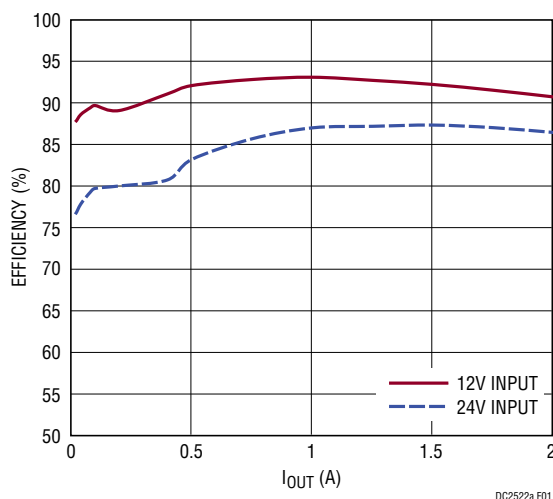

Figure 1. Efficiency vs Load Current at 2MHz Switching Frequency

QUICK START PROCEDURE

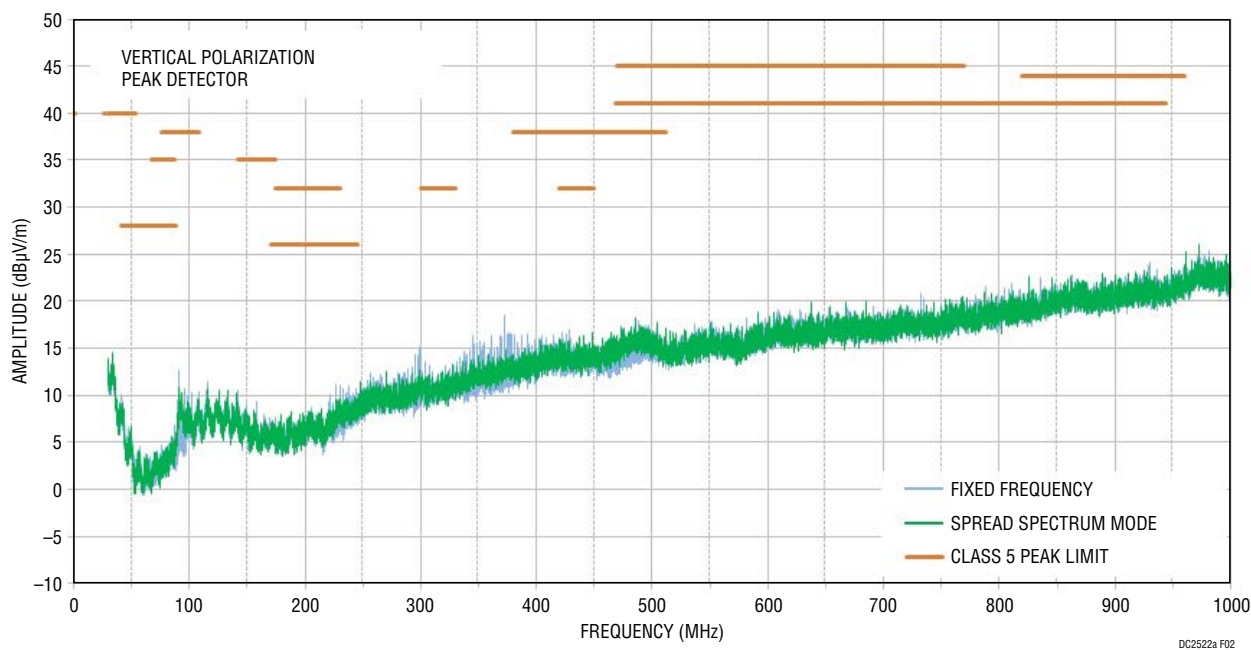

Figure 2. LT8609S Demo Circuit EMI Performance in CISPR25 Radiated Emission Test, Antenna Polarization: Vertical ($V_{IN} = 14V$, $V_{OUT} = 5V$, $I_{OUT} = 2A$, 2MHz Switching Frequency)

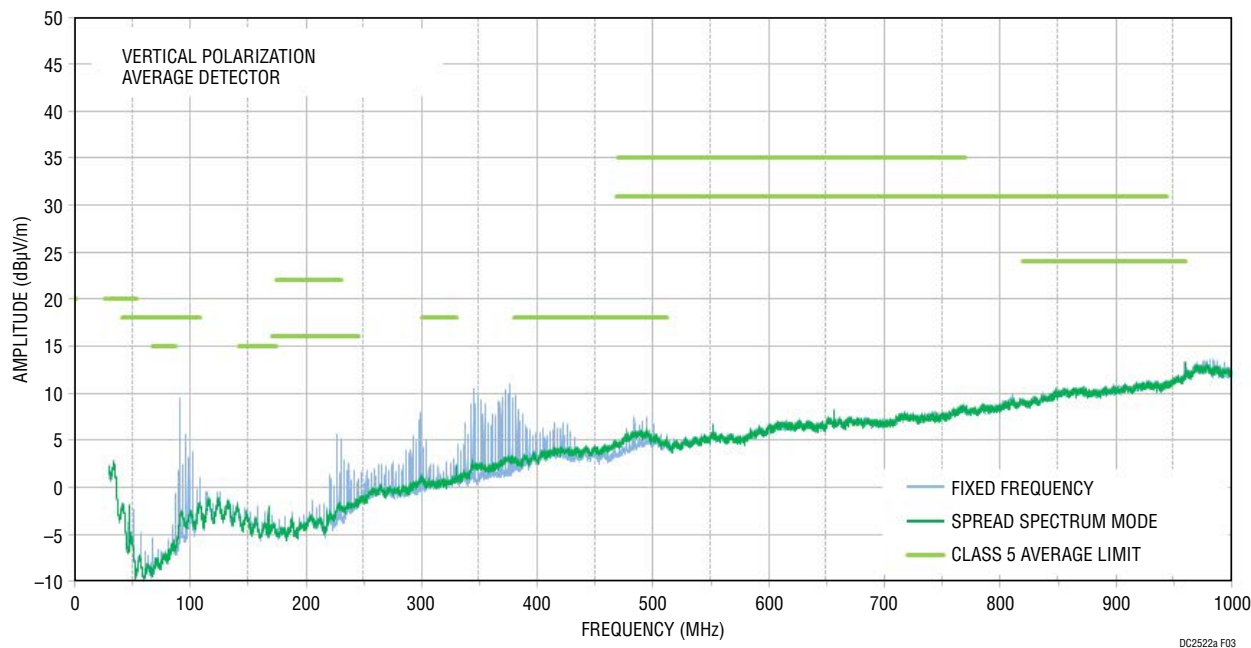

Figure 3. LT8609S Demo Circuit EMI Performance in CISPR25 Radiated Emission Test, Antenna Polarization: Horizontal ($V_{IN} = 14V$, $V_{OUT} = 5V$, $I_{OUT} = 2A$, 2MHz Switching Frequency)

QUICK START PROCEDURE

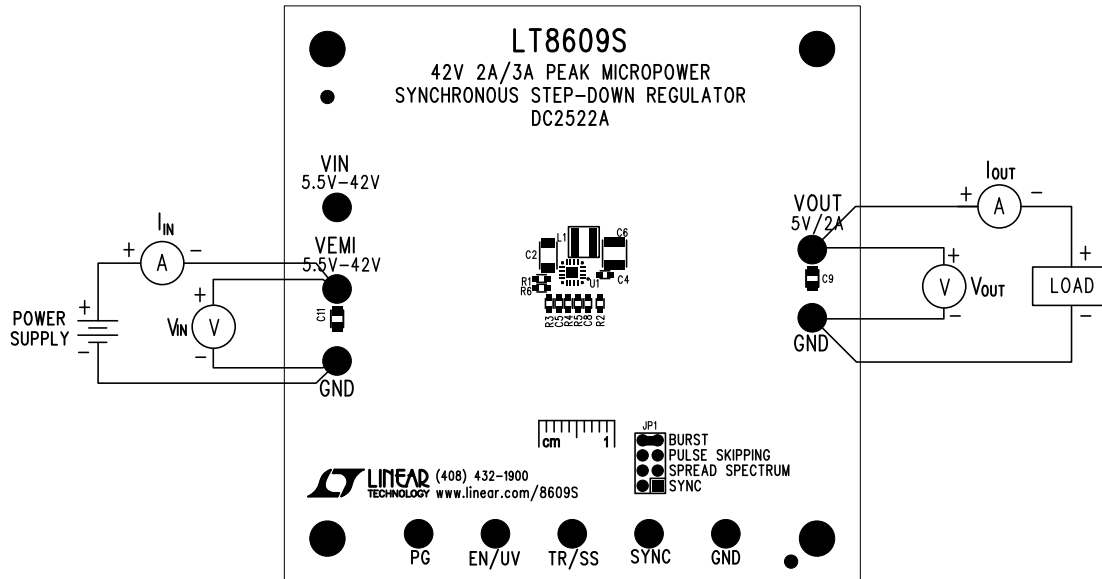

Figure 4. Proper Measurement Equipment Setup

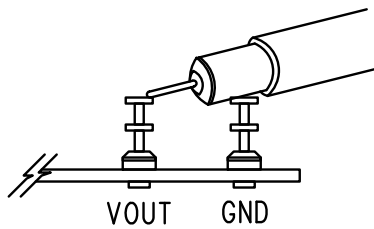

Figure 5. Measuring Output Ripple

QUICK START PROCEDURE

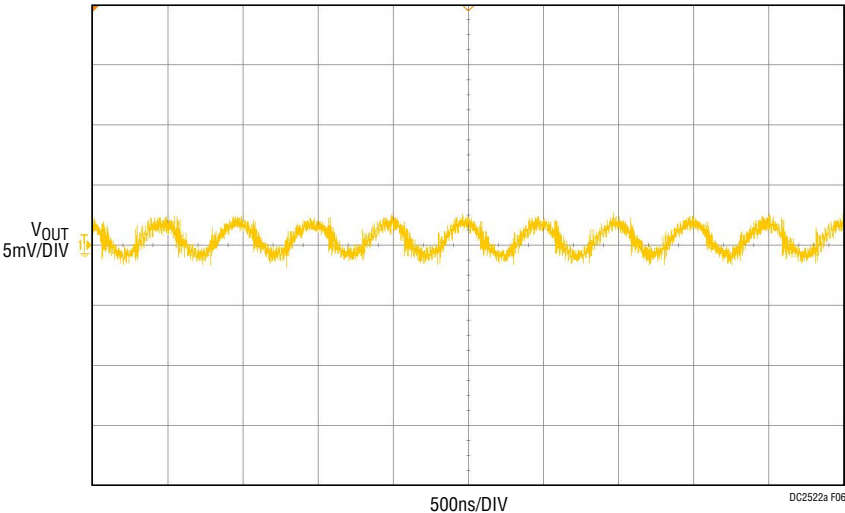

Figure 6. DC2522A Output Ripple ($V_{IN} = 12V$, $V_{OUT} = 5V$, $I_{OUT} = 2A$, 2MHz Switching Frequency)

DEMO MANUAL DC2522A

PARTS LIST

| ITEM | QTY | REFERENCE | PART DESCRIPTION | MANUFACTURER/PART NUMBER |
|-------------------------------------------------|-----|------------|-----------------------------------|-----------------------------------|
| Required Circuit Components | | | | |
| 1 | 1 | C2 | CAP, X7R, 4.7µF, 50V, 10% 1206 | MURATA, GRM31CR71H475KA12L |
| 2 | 1 | C4 | CAP, X7R, 1µF, 25V, 10%, 0603 | MURATA, GRM188R71E105KA12D |
| 3 | 1 | C5 | CAP, C0G, 10pF, 25V, 5%, 0603 | AVX, 06033A100JAT2A |
| 4 | 1 | C6 | CAP, X7R, 47µF, 10V, 10%, 1210 | MURATA, GRM32ER71A476KE15L |
| 5 | 1 | C8 | CAP, X7R, 0.01µF, 16V, 10%, 0603 | AVX, 0603YC103KAT2A |
| 6 | 1 | L1 | IND, 2.2µH | COILCRAFT, XFL4020-222ME |
| 7 | 1 | R2 | RES, CHIP, 18.2k, 1/10W, 1%, 0603 | VISHAY, CRCW060318K2FKEA |
| 8 | 1 | R3 | RES, CHIP, 49.9k, 1/10W, 1%, 0603 | VISHAY, CRCW060349K9FKEA |
| 9 | 2 | R1, R4 | RES, CHIP, 1M, 1/10W, 1%, 0603 | VISHAY, CRCW06031M00FKEA |
| 10 | 1 | R5 | RES, CHIP, 182k, 1/10W, 1%, 0603 | VISHAY, CRCW0603182KFKEA |
| 11 | 1 | U1 | IC, REGULATOR, LQFN-16 | LINEAR TECHNOLOGY, LT8609SEV#PBF |
| Additional Demo Board Circuit Components | | | | |
| 1 | 1 | C1 | CAP, ALUM 22µF 63V | SUN ELECT, 63CE22BS |
| 2 | 2 | C3, C10 | CAP, X7R, 4.7µF, 50V, 10% 1206 | MURATA, GRM31CR71H475KA12L |
| 3 | 1 | C9 | CAP, X7R, 4.7µF, 16V, 10%, 0805 | MURATA, GRM21BR71C475K73L |
| 4 | 1 | C11 | CAP, X7R, 1µF, 50V, 10%, 0805 | MURATA, GRM21BR71H105KA12L |
| 5 | 1 | C12 | CAP, X7R, 0.1µF, 50V, 10%, 0603 | MURATA, GRM188R71H104KA93D |
| 6 | 1 | FB1 | FERRITE BEAD 0805 | TDK, MPZ2012S331AT000 |
| 7 | 1 | L2 | RES, CHIP, 0Ω, 3/4W, 2010 | VISHAY, CRCW20100000Z0EF |
| 8 | 0 | R6 (OPT) | RES, 0603 | |
| Hardware: For Demo Board Only | | | | |
| 1 | 9 | E1 TO E9 | TESTPOINT, TURRET, 0.094" | MILL-MAX, 2501-2-00-80-00-00-07-0 |
| 2 | 1 | E10 (OPT) | TESTPOINT, TURRET, 0.094" | |
| 3 | 1 | JP1 | DOUBLE ROW HEADER 2 × 4 0.079" | SULLINS, NRPNO42PAEN-RC |
| 4 | 1 | XJP1 | SHUNT, 0.079" CENTER | SAMTEC, 2SN-BK-G |
| 5 | 4 | MH1 TO MH4 | STAND-OFF, NYLON 0.50" TALL | KEYSTONE, 8833(SNAP ON) |

SCHEMATIC DIAGRAM

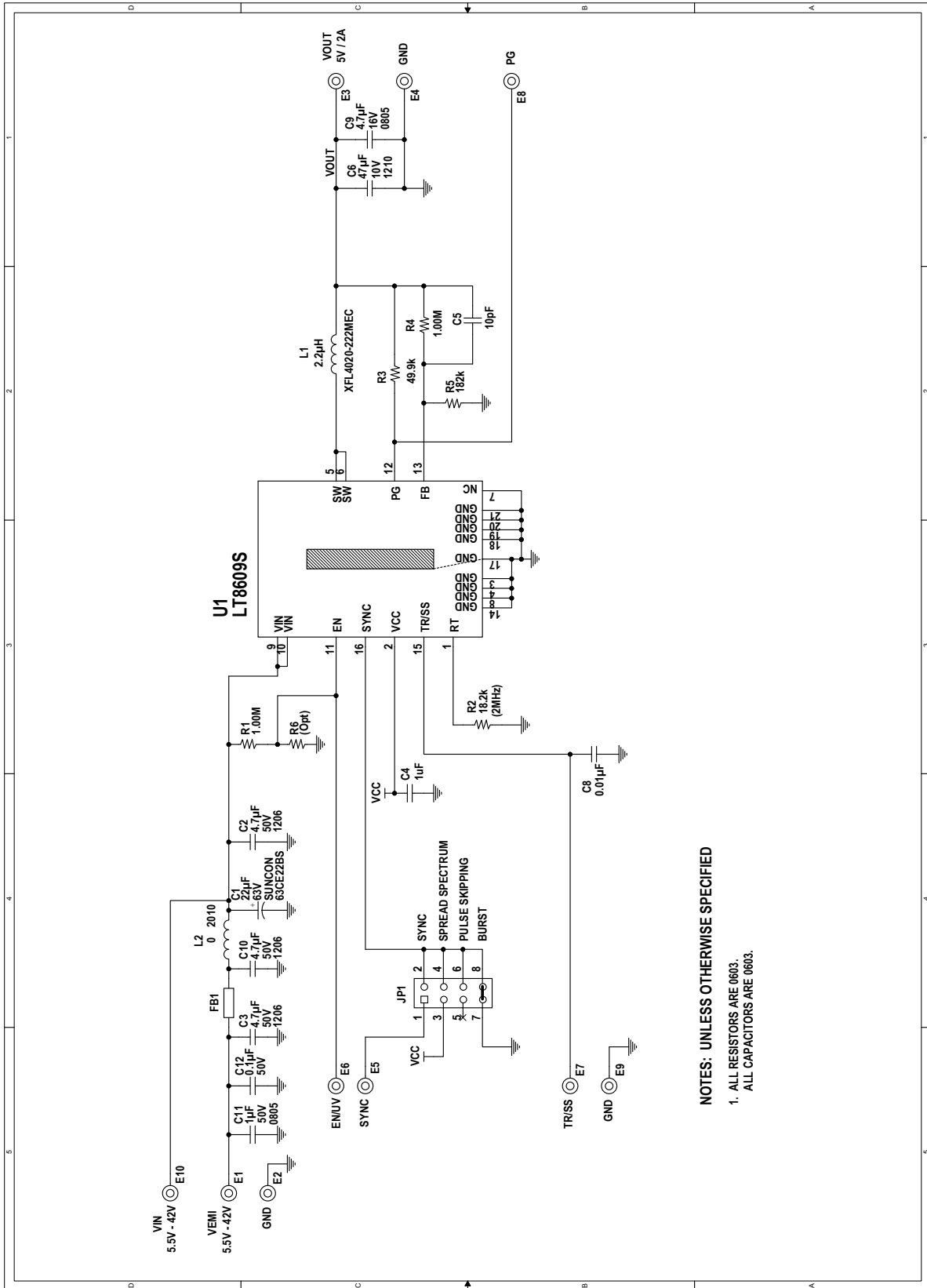

NOTES: UNLESS OTHERWISE SPECIFIED
 1. ALL RESISTORS ARE 0603.
 ALL CAPACITORS ARE 0603.

DEMO MANUAL DC2522A

DEMONSTRATION BOARD IMPORTANT NOTICE

Linear Technology Corporation (LTC) provides the enclosed product(s) under the following **AS IS** conditions:

This demonstration board (DEMO BOARD) kit being sold or provided by Linear Technology is intended for use for **ENGINEERING DEVELOPMENT OR EVALUATION PURPOSES ONLY** and is not provided by LTC for commercial use. As such, the DEMO BOARD herein may not be complete in terms of required design-, marketing-, and/or manufacturing-related protective considerations, including but not limited to product safety measures typically found in finished commercial goods. As a prototype, this product does not fall within the scope of the European Union directive on electromagnetic compatibility and therefore may or may not meet the technical requirements of the directive, or other regulations.

If this evaluation kit does not meet the specifications recited in the DEMO BOARD manual the kit may be returned within 30 days from the date of delivery for a full refund. **THE FOREGOING WARRANTY IS THE EXCLUSIVE WARRANTY MADE BY THE SELLER TO BUYER AND IS IN LIEU OF ALL OTHER WARRANTIES, EXPRESSED, IMPLIED, OR STATUTORY, INCLUDING ANY WARRANTY OF MERCHANTABILITY OR FITNESS FOR ANY PARTICULAR PURPOSE. EXCEPT TO THE EXTENT OF THIS INDEMNITY, NEITHER PARTY SHALL BE LIABLE TO THE OTHER FOR ANY INDIRECT, SPECIAL, INCIDENTAL, OR CONSEQUENTIAL DAMAGES.**

The user assumes all responsibility and liability for proper and safe handling of the goods. Further, the user releases LTC from all claims arising from the handling or use of the goods. Due to the open construction of the product, it is the user's responsibility to take any and all appropriate precautions with regard to electrostatic discharge. Also be aware that the products herein may not be regulatory compliant or agency certified (FCC, UL, CE, etc.).

No License is granted under any patent right or other intellectual property whatsoever. **LTC assumes no liability for applications assistance, customer product design, software performance, or infringement of patents or any other intellectual property rights of any kind.**

LTC currently services a variety of customers for products around the world, and therefore this transaction **is not exclusive**.

Please read the DEMO BOARD manual prior to handling the product. Persons handling this product must have electronics training and observe good laboratory practice standards. **Common sense is encouraged.**

This notice contains important safety information about temperatures and voltages. For further safety concerns, please contact a LTC application engineer.

Mailing Address:

Linear Technology
1630 McCarthy Blvd.
Milpitas, CA 95035

Copyright © 2004, Linear Technology Corporation