



## Features

- Wirewound
- Shielded construction
- Metal alloy powder core
- High saturation current
- Low profile
- AEC-Q200 qualified
- RoHS compliant\* and halogen free\*\*

## Applications

- Automotive systems:
  - Driver assistant
  - Lighting
  - Infotainment
- DC/DC converters
- Power supplies
- Smartphones
- HDD/SSD
- Miniature mobile electronic devices

# SRP2510A Series - Shielded Power Inductors

### Electrical Specifications @ 25 °C

Bourns Part Number	Inductance @ 1 MHz / 1 V		Q (Typ.) @ 1 MHz / 1 V	SRF (MHz) Typ.	DCR (mΩ) Typ.	DCR (mΩ) Max.	I <sub>rms</sub> (A) Typ.	Isat (A) Typ.
	L (μH)	Tol. (%)						
SRP2510A-R22M	0.22	±20	35	170	9	12.5	5.9	7.9
SRP2510A-R33M	0.33	±20	35	170	21	26	4.4	6.6
SRP2510A-R47M	0.47	±20	35	138	27	32	3.9	5.0
SRP2510A-R68M	0.68	±20	35	120	37	44	3.4	4.3
SRP2510A-1R0M	1.0	±20	35	94	45	54	3.0	3.5
SRP2510A-1R5M	1.5	±20	35	68	76	91	2.5	2.6
SRP2510A-2R2M	2.2	±20	35	57	99	119	2.3	2.4
SRP2510A-4R7M	4.7	±20	35	40	220	262	1.36	1.8

### Soldering Profile

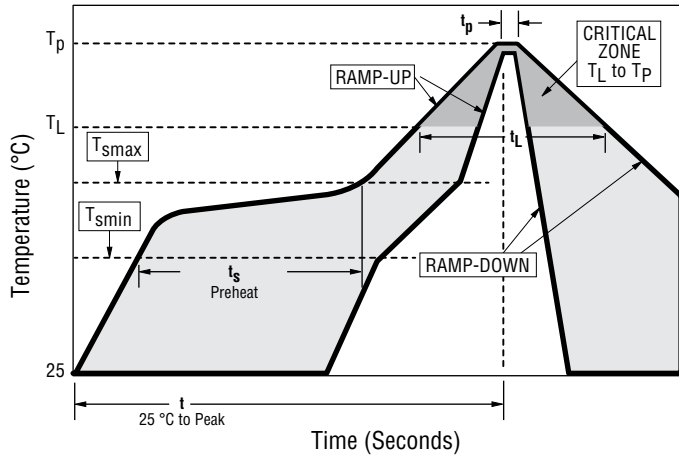

Profile Feature	Pb Free Assembly
Average Ramp Rate (T <sub>Smax</sub> to T <sub>P</sub> )	3 °C/second max.
Preheat	
- Temperature Min. (T <sub>Smin</sub> )	150 °C
- Temperature Max. (T <sub>Smax</sub> )	200 °C
- Time (t <sub>Smin</sub> to t <sub>Smax</sub> )	60-180 seconds
Time Maintained Above	
- Temperature (T <sub>L</sub> )	217 °C
- Time (t <sub>L</sub> )	60-150 seconds
Peak Temperature (T <sub>P</sub> )	260 °C +0/-5 °C
Time within 5 °C of Actual Peak Temperature (T <sub>P</sub> )	20-40 seconds
Ramp-Down Rate	6 °C/second max.
Time 25 °C to Peak Temperature	8 minutes max.

### General Specifications

Operating Temperature...-40 °C to +125 °C  
 (Temperature rise included)  
 Storage Temperature (Component)  
 .....-50 °C to +125 °C  
 Rated Current  
 ..... Inductance drops 30 % at Isat  
 Temperature Rise .....40 °C at rated I<sub>rms</sub>  
 Moisture Sensitivity Level (MSL) ..... 1  
 ESD Classification (HBM).....3B

### Materials

Core..... Metal alloy powder  
 Wire ..... Enameled copper  
 Terminal Finish ..... Sn  
 Packaging..... 3000 pcs. per 7-inch reel

### Product Dimensions

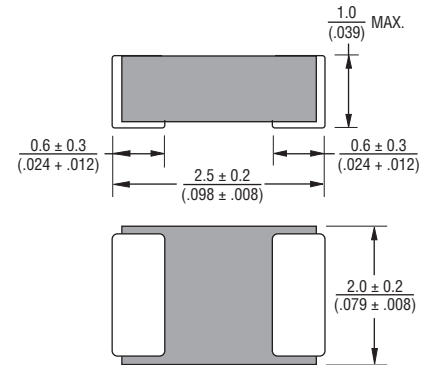

### Recommended Layout

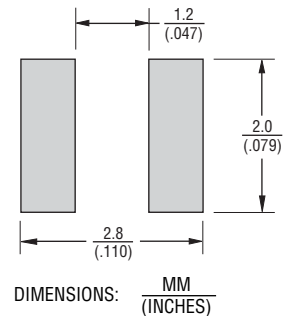

### Electrical Schematic

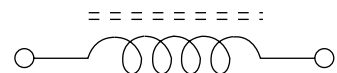

### How to Order

**SRP2510A - R22M**

Model \_\_\_\_\_  
 Value Code (see table) \_\_\_\_\_

\* RoHS Directive 2002/95/EC Jan. 27, 2003 including annex and RoHS Recast 2011/65/EU June 8, 2011.  
 \*\*Bourns considers a product to be "halogen free" if (a) the Bromine (Br) content is 900 ppm or less; (b) the Chlorine (Cl) content is 900 ppm or less; and (c) the total Bromine (Br) and Chlorine (Cl) content is 1500 ppm or less.  
 Specifications are subject to change without notice.  
 The device characteristics and parameters in this data sheet can and do vary in different applications and actual device performance may vary over time.  
 Users should verify actual device performance in their specific applications.

# SRP2510A Series - Shielded Power Inductors



## L vs. I Charts

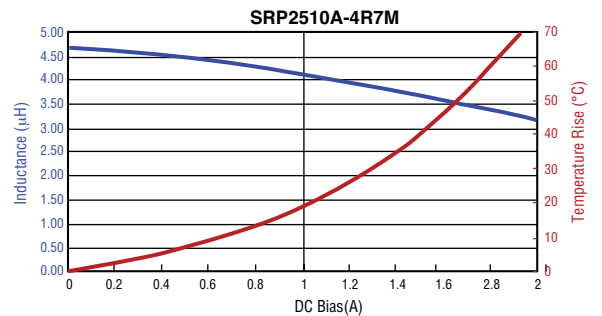
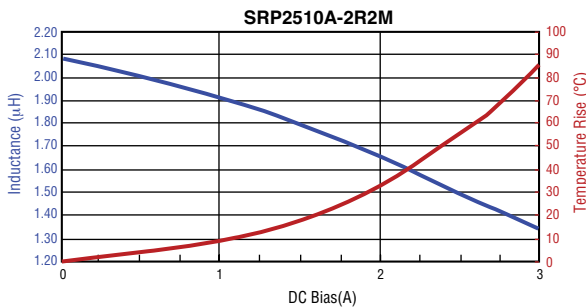
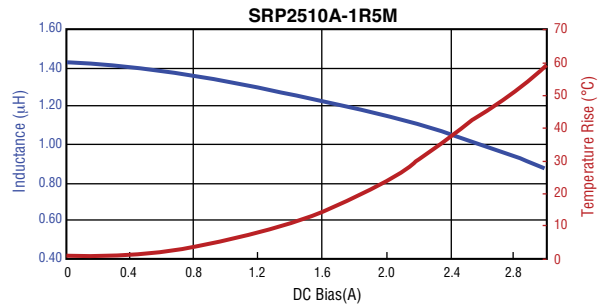
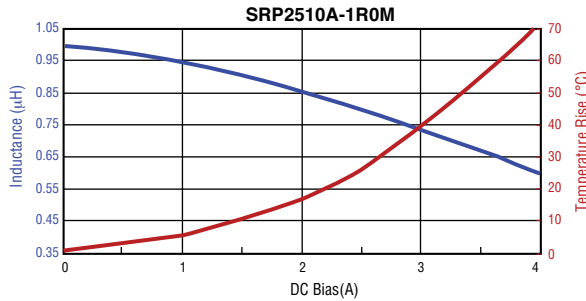
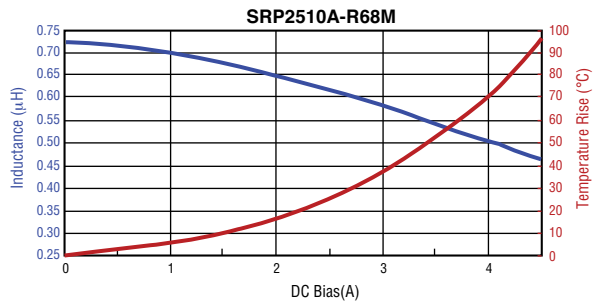
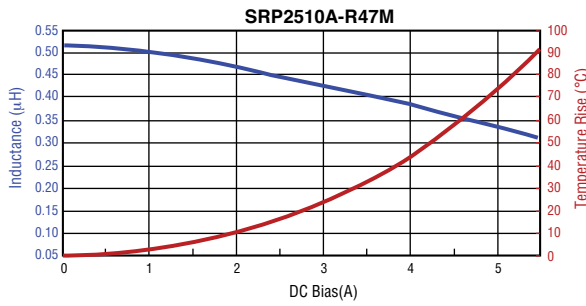
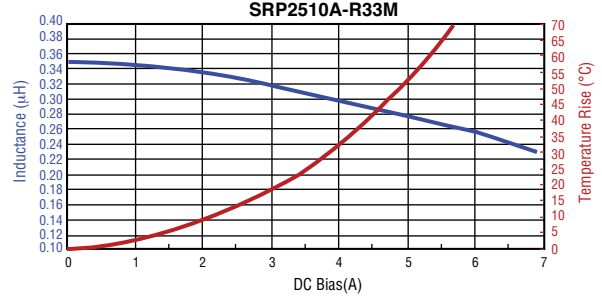
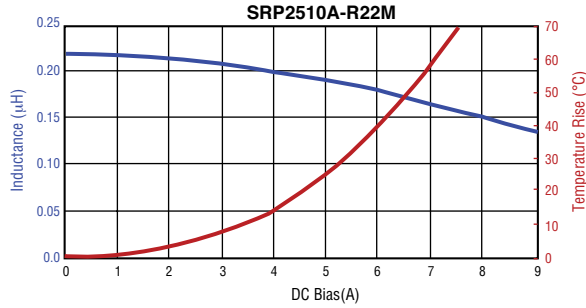

Specifications are subject to change without notice.  
 The device characteristics and parameters in this data sheet can and do vary in different applications and actual device performance may vary over time.  
 Users should verify actual device performance in their specific applications.

# SRP2510A Series - Shielded Power Inductors

**BOURNS®**

## Packaging Specifications

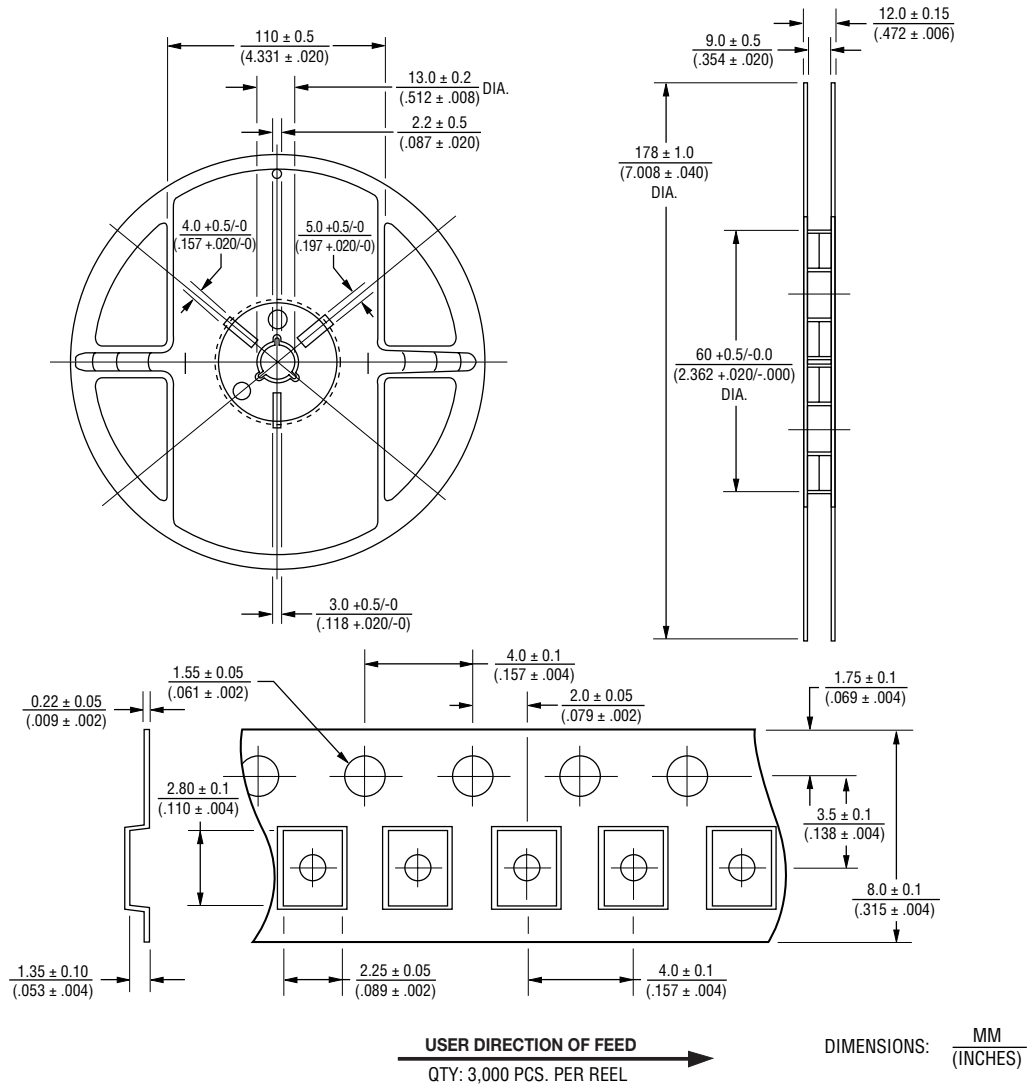

05/17

Specifications are subject to change without notice.  
 The device characteristics and parameters in this data sheet can and do vary in different applications and actual device performance may vary over time.  
 Users should verify actual device performance in their specific applications.