

DATE	REV.	ECN	APP'D BY
4-1-05	X0	-	TRM
9-22-05	A0	7298	TRM
10-28-05	B0	7359	TRM
1-6-06	B1	7426	TRM

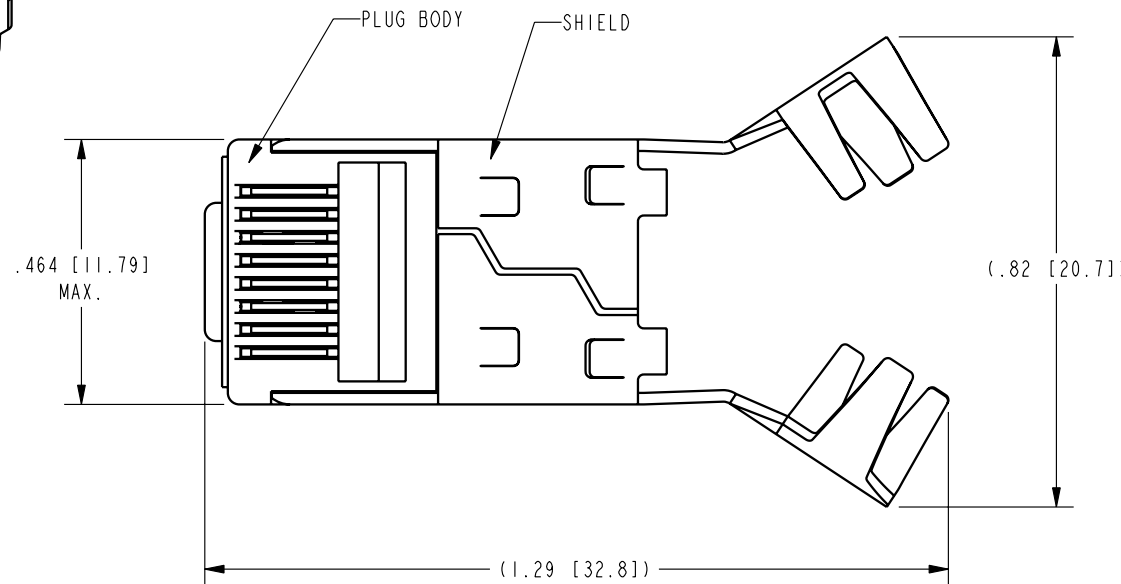

NOTES:

- PLUG KIT CONSISTS OF:
PRE-INSERTED PLUG BODY WITH SHIELD
LOAD BAR
- MATERIALS:
PLUG BODY: CLEAR POLYCARBONATE, UL 94-V0
LOAD BAR: CLEAR POLYCARBONATE, UL 94-V0
CONTACTS: COPPER ALLOY, SELECTIVE GOLD PLATING
SHIELD: COPPER ALLOY, NICKEL PLATE
- FOR PRODUCT SPECIFICATIONS SEE PR026-01.
- CONTACTS TERMINATE SOLID OR STRANDED CONDUCTORS BETWEEN .037 [0.94] TO .042 [1.07] OUTSIDE DIAMETER OF INSULATION.
- CRIMP IS FOR CABLES WITH OUTSIDE NOMINAL DIAMETERS OF .220 [5.59] TO .240 [6.10].
- PRODUCT DESIGNED FOR CATEGORY 6 APPLICATIONS.
- TOLERANCES COMPLY WITH F.C.C. DIMENSION REQUIREMENTS.
- TERMINATED PLUG HEIGHT: .237 [6.02] ±.005 [0.13].

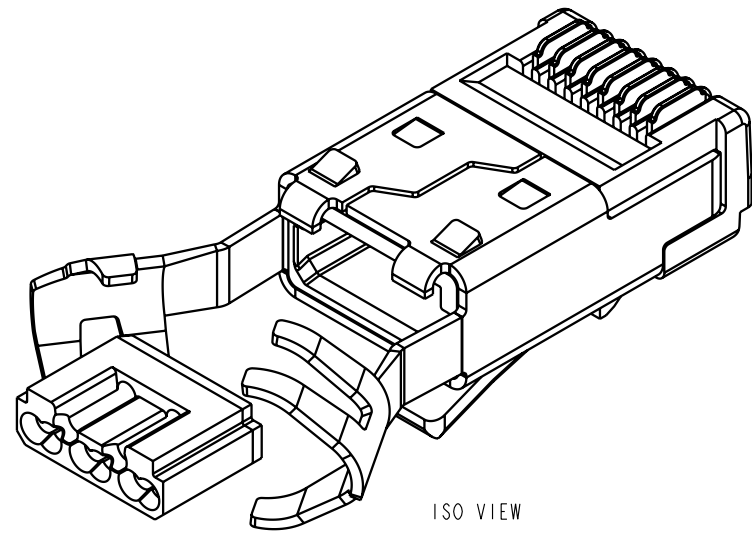
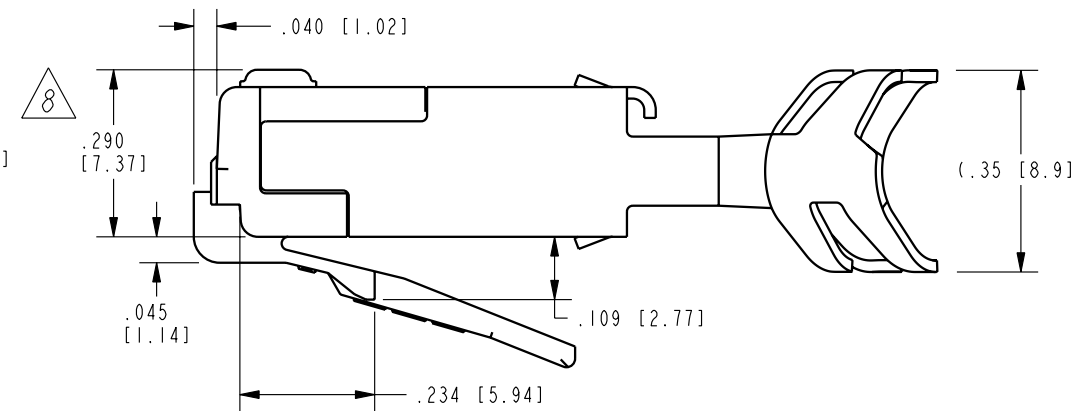
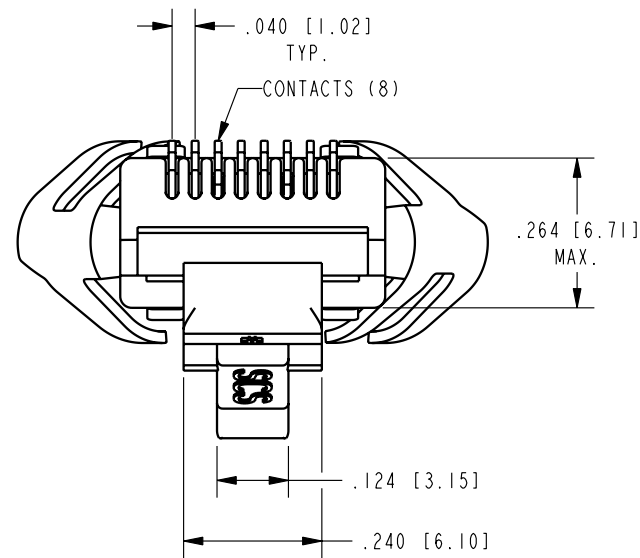

BULK	50 MICRO-INCHES [1.27um]	SS-39200-012
PACKAGE	CONTACT PLATING IN MATING AREA	PART NUMBER

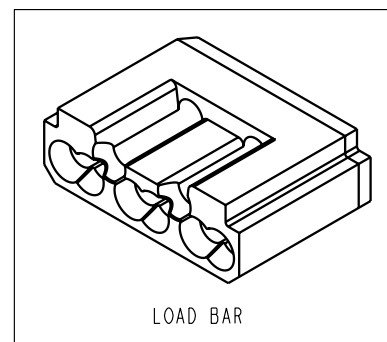

THIRD ANGLE PROJECTION

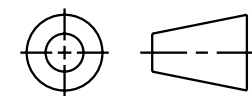

Bel Stewart Connector

11118 Susquehanna Trail South
Glen Rock, PA 17327-9199
(717) 235-7512 Fax: (717) 235-7954 <http://www.stewartconnector.com>

DO NOT SCALE DRAWING

DRAWING IS SUBJECT TO CHANGE WITHOUT NOTICE

DIMENSIONS: INCHES [METRIC]

UNLESS OTHERWISE SPECIFIED TOLERANCES ARE ±.005 [0.13] ANGLES ARE ±1°

SHEET NO. 1 OF 1

TITLE: 8 CONDUCTOR, 8 POSITION SHIELDED CAT 6 PLUG WITH LOAD BAR

THIS DRAWING AND THE SUBJECT MATTER SHOWN THEREON ARE CONFIDENTIAL AND THE PROPRIETARY PROPERTY OF BEL STEWART CONNECTOR AND SHALL NOT BE REPRODUCED, COPIED, OR USED IN ANY MANNER WITHOUT PRIOR WRITTEN CONSENT OF BEL STEWART CONNECTOR. THE SUBJECT MATTER MAY BE PATENTED OR A PATENT MAY BE PENDING.

DRN BY: TRM	DATE 4-1-05
CKD BY: RGC	DATE 4-1-05
APPD BY: TRM	DATE 4-1-05
DWG. NO. CT390039	REV. B1

Bel Stewart Connector

Shielded 39200 Series Assembly Instructions
Individually Shielded Pair Cable

11118 Susquehanna Trail South Glen Rock, PA 17327

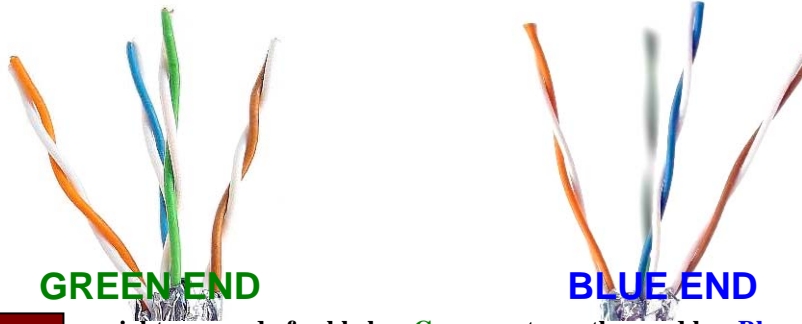

With **Orange** on left and **Brown** on right, one end of cable has **Green** on top, other end has **Blue** on top. **Green** end steps will be shown on left, **Blue** steps shown on right. Common steps will be in the middle.

INDIVIDUALLY SHIELDED PAIRS For Cable with Overall Shield See Page 6



1

Trim off approx. 1.75 to 2.00 inches of cable jacket
Do not nick shield

2



Fold shield back over cable jacket

3

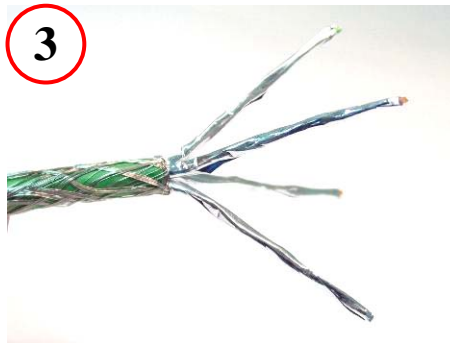

Spread apart pairs

Bel Stewart Connector

Shielded 39200 Series Assembly Instructions
Individually Shielded Pair Cable
11118 Susquehanna Trail South Glen Rock, PA 17327

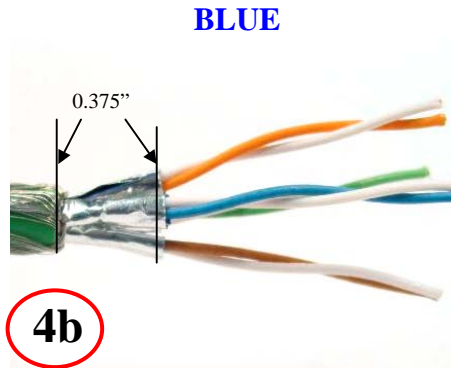
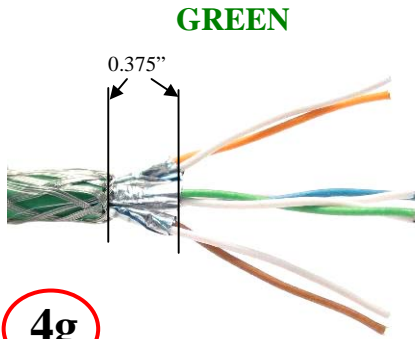

Trim individual pair shields, leaving approximately 0.375 inches (3/8") sticking out beyond cable jacket

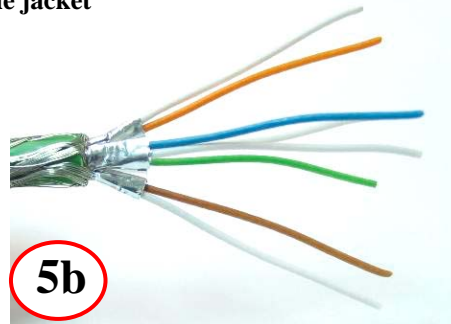
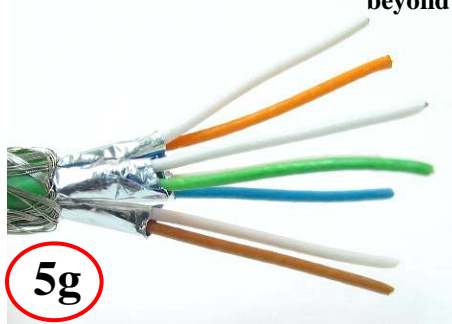

Untwist pairs back to ends of shields



Here, **Brn** pair has incorrect alignment
Add 1/2 twist as low as possible

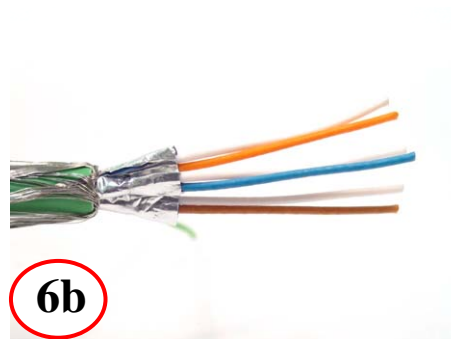

Here, **Blu** pair has incorrect alignment
Add 1/2 twist as low as possible



Brn pair is now in correct alignment

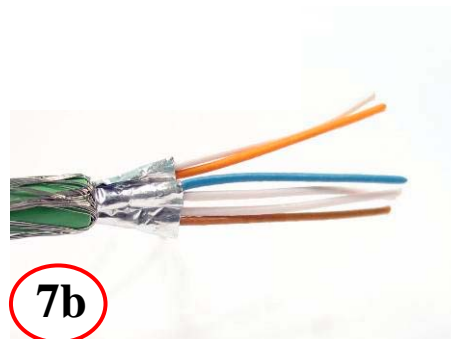

Blu pair is now in correct alignment

Bel Stewart Connector

Shielded 39200 Series Assembly Instructions
Individually Shielded Pair Cable
11118 Susquehanna Trail South Glen Rock, PA 17327

GREEN

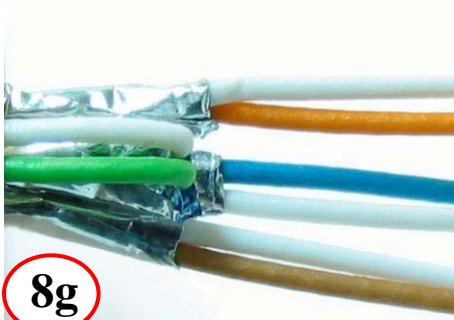

Fold **Grn** pair back

BLUE

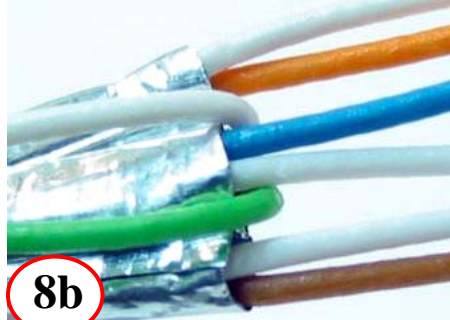

Split **Grn** pair around **Blu** pair, then fold back



Trim ends of **Org** **Blu** and **Brn** pairs @ slight angle to make loading easier



Insert **Org** **Blu** and **Brn** pairs into load bar
Leave load bar near end of pairs

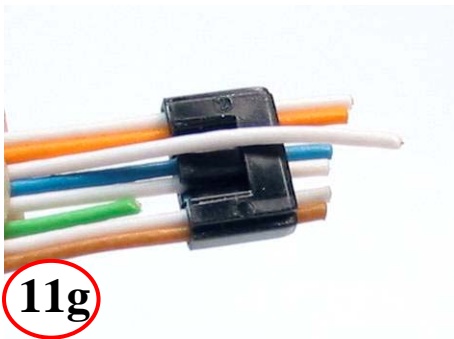
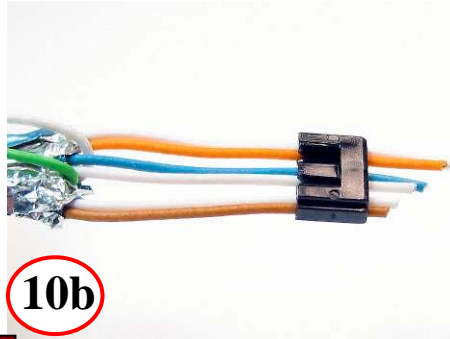

Bring up **Grn** pair and trim so it fits into load bar

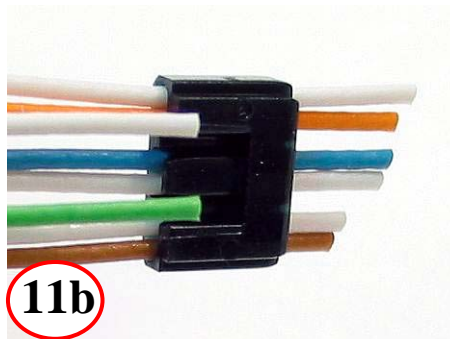

Bel Stewart Connector

Shielded 39200 Series Assembly Instructions
Individually Shielded Pair Cable
11118 Susquehanna Trail South Glen Rock, PA 17327

GREEN

BLUE



12g

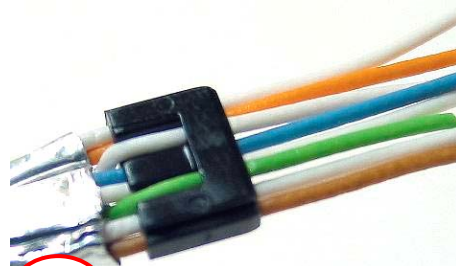

12b

Slide load bar down to base of pairs



13g



13b

Trim off wire ends at approx. 0.2 inches (3/16")



14g



14b

Slide load bar to end of pairs to make loading into housing easier

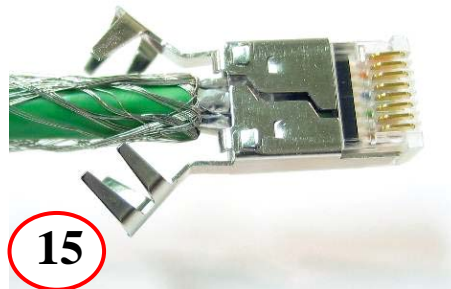

15

Gently insert assembly into housing

Bel Stewart Connector

Shielded 39200 Series Assembly Instructions
Individually Shielded Pair Cable
11118 Susquehanna Trail South Glen Rock, PA 17327



16

Close shield fingers by hand

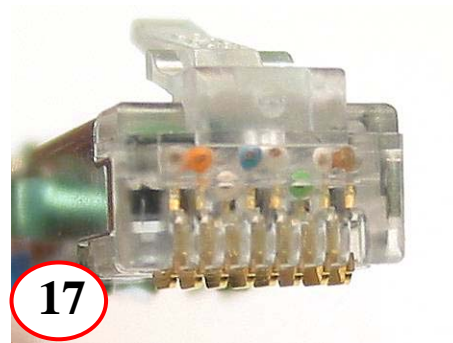

17

Verify wires are visible through end of plug



18

Crimp contacts and shield fingers. Trim off excess shield

Bel Stewart Connector

Shielded 39200 Series Assembly Instructions
Overall Shield Cable

11118 Susquehanna Trail South Glen Rock, PA 17327

OVERALL SHIELD

For Cable with Individual Shielded Pairs See Page 1



1

Trim off approx. 1.75 to 2.00 inches of cable jacket
Do not nick shield



2

Fold shield back over cable jacket

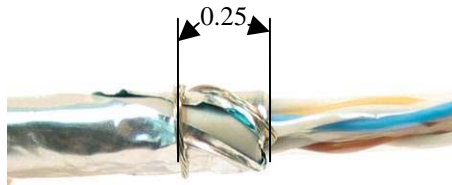

3

Wrap drain around cable 1/4" (0.25")
behind end of jacket



4

Remove any inner insulating jacket

Bel Stewart Connector

Shielded 39200 Series Assembly Instructions
Overall Shield Cable

11118 Susquehanna Trail South Glen Rock, PA 17327

GREEN

BLUE

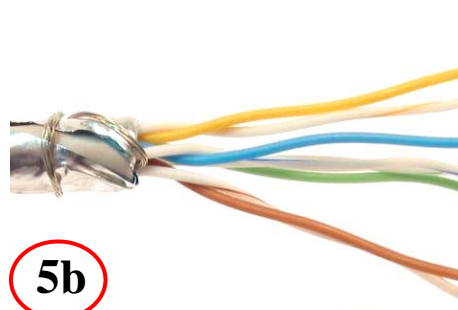

Untwist individual pairs to approximately 0.375 inches (3/8") beyond cable jacket



Here, **Grn** pair has incorrect alignment
Add 1/2 twist as low as possible



Here **Org** pair has incorrect alignment
Add 1/2 twist as low as possible

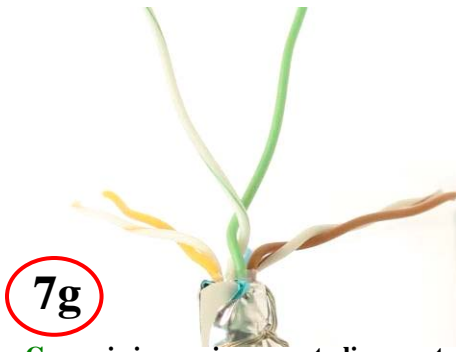

Grn pair is now in correct alignment



Org pair is now in correct alignment

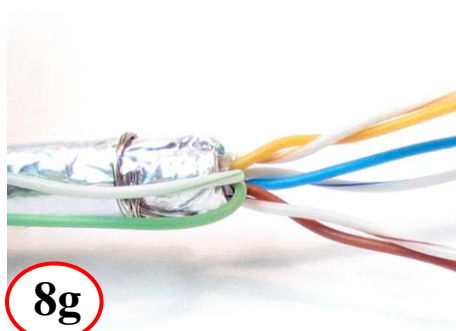

Fold **Grn** pair back

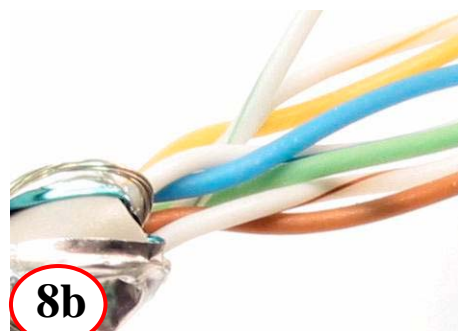

Split **Grn** pair around **Blu** pair, then
fold back

Bel Stewart Connector

Shielded 39200 Series Assembly Instructions
Overall Shield Cable

11118 Susquehanna Trail South Glen Rock, PA 17327

GREEN

BLUE

9



Trim ends of **Org** **Blu** and **Brn** pairs @ slight angle to make loading easier

10

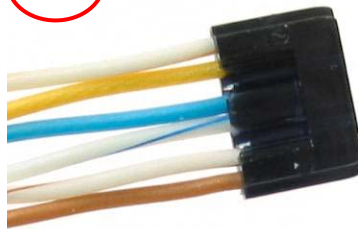

Insert **Org** **Blu** and **Brn** pairs into load bar
Leave load bar near end of pairs

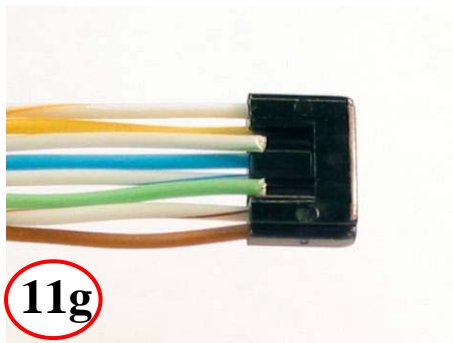

11g

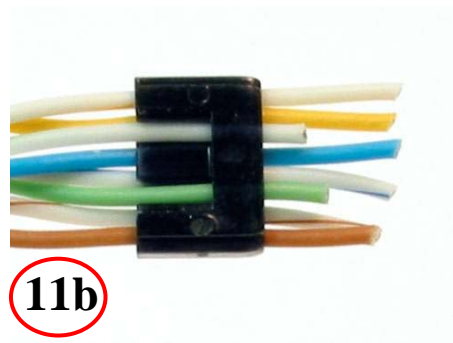

11b

Bring up **Grn** pair and trim so it fits into load bar

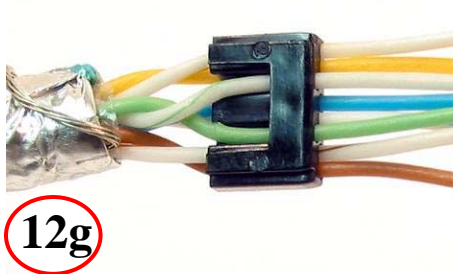

12g

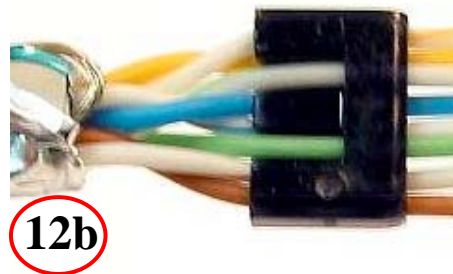

12b

Slide load bar down to base of pairs

Bel Stewart Connector

Shielded 39200 Series Assembly Instructions
Overall Shield Cable

11118 Susquehanna Trail South Glen Rock, PA 17327

GREEN

BLUE

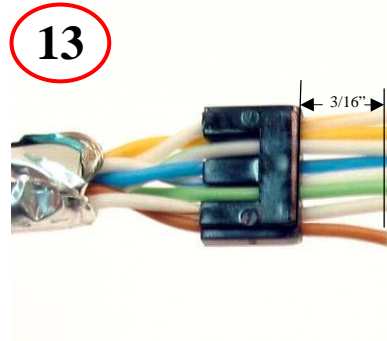

Trim off wire ends at approx. 0.2 inches (3/16")

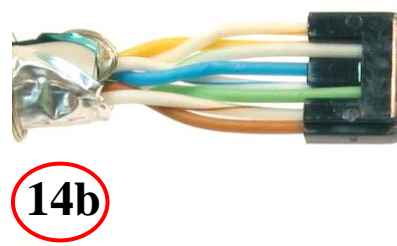
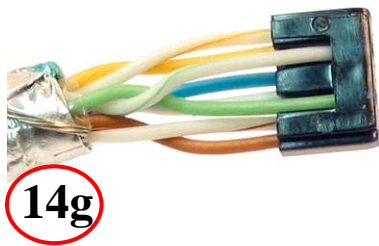

Slide load bar to end of pairs to make loading into housing easier

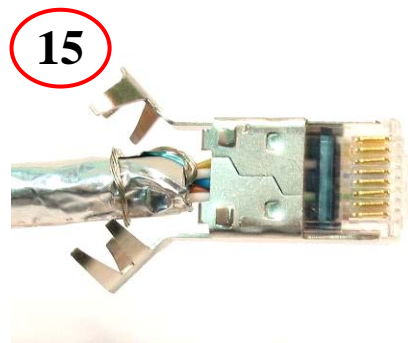

Gently insert assembly into housing



Close shield fingers by hand
Keep drain wire entirely under fingers

Bel Stewart Connector

Shielded 39200 Series Assembly Instructions
Overall Shield Cable

11118 Susquehanna Trail South Glen Rock, PA 17327

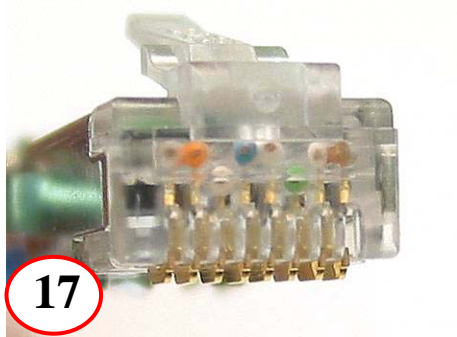

17
Verify wires are visible through end of plug

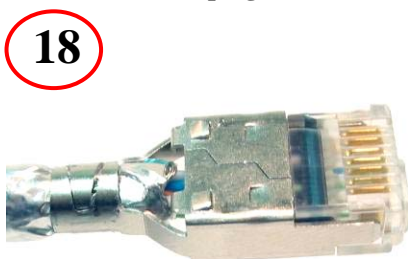

18
Crimp contacts and shield fingers

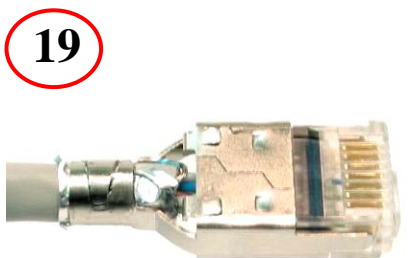

19
Trim off excess foil shield