

OTe 18/220...240/500 PC

OPTOTRONIC Phase-cut OTE | Compact constant current LED driver – Dimmable

Product family features

- Dimmable via leading edge/trailing edge
- Type of protection: IP20



Product family benefits

- Compact housing for mounting in very tight spaces
- Compatible with the most common leading-edge and trailing-edge phase dimmers

Areas of application

- Optional cable clamp E-style for independent mounting
- Suitable for indoor installations
- Suitable for indoor SELV installations



Technical data

Electrical data

Nominal input voltage	220...240 V
Mains frequency	50/60 Hz
Input voltage AC	198...264 V ¹⁾
Total harmonic distortion	15 %
Power factor λ	0.95/0.90 ²⁾
ECG efficiency	86 % ³⁾
Device power loss	3.0 W ⁴⁾
Inrush current	5 A ⁵⁾
Max. ECG no. on circuit breaker 10 A (B)	53
Max. ECG no. on circuit breaker 16 A (B)	84
Max. ECG no. on circuit breaker 25 A (B)	-
Surge capability (L/N-Ground)	1 kV
Surge capability (L-N)	1 kV
Nominal output voltage	18...36 V ⁶⁾
U-OUT (working voltage)	60 V
Nominal output current	500 mA ⁷⁾
Output current tolerance	±10 %
Output ripple current (100 Hz)	< 35 % ⁸⁾
Output PSTLM	≤1
Output SVM	≤0.6
Nominal output power	18 W ⁹⁾
Galvanic isolation	SELV

¹⁾ Permitted voltage range

²⁾ Full load at 230 V/Minimum load at 230 V

³⁾ At full load and 230 V

⁴⁾ Maximum

⁵⁾ $t_{width} = 100 \mu s$ (measured at 50 % I_{peak})

⁶⁾ Maximum <48 V

⁷⁾ ±10%

⁸⁾ Typical

⁹⁾ Partial load 9...18 W

Dimensions & weight

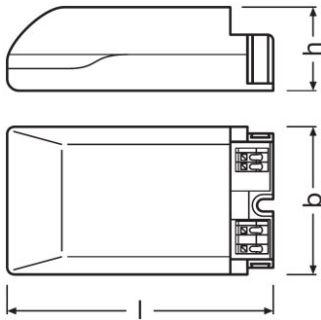

Mounting hole spacing, length	-
Mounting hole spacing, width	-
Product weight	93.00 g
Cable cross-section, input side	0.75...1.5 mm ² ¹⁾
Cable cross-section, output side	0.5...1.5 mm ² ¹⁾
Wire preparation length, input side	8.0...9.0 mm
Wire preparation length, output side	8.0...9.0 mm
Length	95.0 mm
Width	53.0 mm
Height	30.0 mm

¹⁾ Flexible / Solid leads

Colors & materials

Casing material	Plastic
-----------------	---------

Temperatures & operating conditions

Ambient temperature range	-20...+55 °C
Maximum temperature at tc test point	75 °C ¹⁾
Max.housing temperature in case of fault	110 °C
Temperature range at storage	-25...75 °C
Permitted rel. humidity during operation	5...85 % ²⁾

¹⁾ Maximum at the T_c-point

²⁾ Maximum 56 days/year at 85 %

Lifespan

ECG lifetime	50000 h ¹⁾
--------------	-----------------------

¹⁾ At $T_{case} = 70^{\circ}C$ at T_c point / 10% failure rate

Product datasheet

Capabilities

Dimmable	Yes
Dimming interface	Phase Cut ¹⁾
Dimming range	10...100 %
Dimming method	Amplitude Modulation
Overheating protection	Automatic reversible
Overload protection	Automatic reversible
Short-circuit protection	Automatic reversible
No-load proof	Yes
Max. cable length to lamp/LED module	2.0 m
Suitable for fixtures with prot. class	I / II
Type of connection, output side	Push terminal

¹⁾ Leading edge / Trailing edge







Certificates & standards

Approval marks – approval	CE / ENEC 10 / VDE / CB
Standards	Acc. to IEC 61347/Acc. to IEC 61347-2-13/Acc. to IEC 62384/Acc. to CISPR 15/Acc. to IEC 61000-3-2/Acc. to IEC 61000-3-3/Acc. to IEC 61547
Protection class	II
Type of protection	IP20





Logistical data

Commodity code	850440829000
-----------------------	--------------

Download Data

File	
	Certificates OT EMC 40038482 060720
	Certificates OT ENEC 40038447 210721
	Certificates 503096_CB report OTe 25 700 PC - OTe 18 350 PC - OTe 18 500
	Declarations of conformity OTe PC UK DoC 4281102 180221
	Declarations of conformity OTE PC CE 3365230 180221
	Installation/Operation notice OT PC dimmer list (EN)

Product datasheet

	Installation guide 501495_OTe 18220-240500 PC
	CAD data 3-dim 377015_OTe 18-25 PC -cable clamp
	CAD data 3-dim 377016_OTe 18-25 PC -housing
	CAD data 3-dim 377017_OTe 18-25 PC -housing with cable clamp

Logistical Data

Product code	Product description	Packaging unit (Pieces/Unit)	Dimensions (length x width x height)	Volume	Gross weight
4052899105362	OTe 18/220...240/500 PC	Shipping carton box 20	284 mm x 207 mm x 100 mm	5.88 dm ³	2478.00 g

The mentioned product code describes the smallest quantity unit which can be ordered. One shipping unit can contain one or more single products. When placing an order, for the quantity please enter single or multiples of a shipping unit.

Disclaimer

Subject to change without notice. Errors and omission excepted. Always make sure to use the most recent release.