

## M12 FEMALE 90° SHIELDED

PVC 12x0,14 shielded black 3m

M12  
Female 90°  
12-pole, shielded

Plastic housings with good resistance against chemicals and oils. The resistance to aggressive media should be individually tested for your application. Further details on request. Further cable lengths on request.

### [Link to Product](#)

#### Illustration



1	▷	brown
2	▷	blue
3	▷	white
4	▷	green
5	▷	pink
6	▷	yellow
7	▷	black
8	▷	gray
9	▷	red
10	▷	violet
11	▷	gray/pink
12	▷	red/blue
		shield

## Female

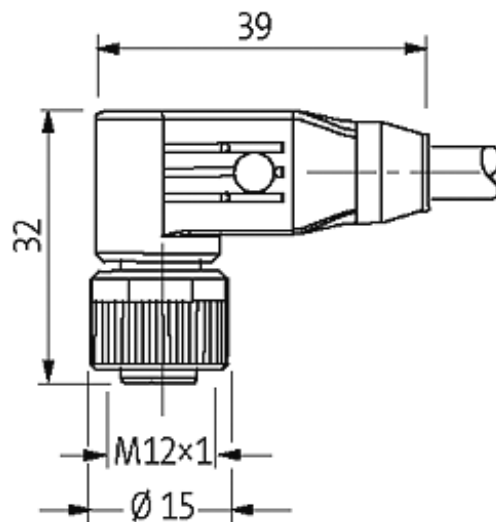
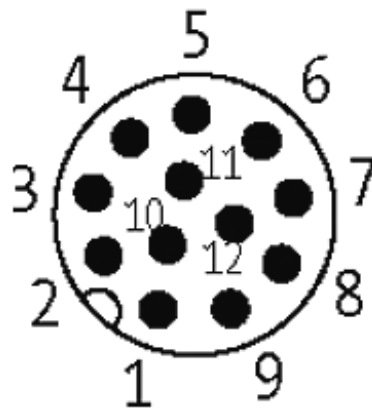

Product may differ from Image

## Approvals



## Form

19361

## Technical Data

Operating voltage	max. 30 V AC/DC
Operating current per contact	max. 1.5 A
Locking of ports	Screw thread M12 × 1 mm (recommended torque 0.6 Nm) self-securing
Protection	IP67 inserted and tightened (EN 60529)

## Cables

Cable number	703
--------------	-----

No./diameter of wires	12 × 0.14 mm <sup>2</sup>
Wire isolation	PVC (br, bl, wh, gn, pk, ye, bk, gr, rd, vi, grpk, rdbl)
Jacket Color	black
Shore hardness outer jacket	75 ± 5A
Material (jacket)	PVC
Outer diameter	approx. 6.5 mm
Bend radius (fixed)	5 × outer Ø
Bend radius (moving)	10 × outer Ø
Temperature range (fixed)	-30...+70 °C
Temperature range (mobile)	-5...+70 °C
Shielded	yes

#### General data

Temperature range	-25...+85 °C, depending on cable quality
-------------------	--

#### Commercial data

country of origin	DE
customs tariff number	85444290
minimum order quantity	1