

Weld-Splatter Resistant Actuator and Sensor Cable
Connection cable
RSC4.4T-2/TXL1001

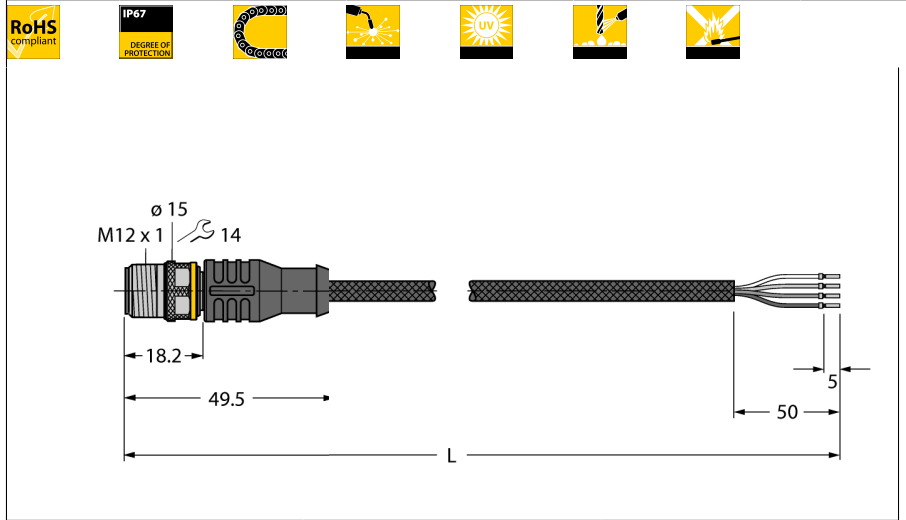

- Male M12, straight, 4-pin
- Jacket material: PUR jacketed with aramid
- Jacket color: yellow
- Resistant to welding sparks
- Flame-retardant
- Resistant to chemicals, UV radiation and oils
- Free from halogen, silicone, PVC and LABS
- RoHS-compliant
- Protection class IP67
- Protective jacket material: Aramid fibers
 - Tensile strength: 2923 MPa
 - Breaking strength: 333 N
 - Elongation at break: 3.6%
 - Temperature peaks: up to +200 °C
- Cable length: 2.0 m

Type designation	RSC4.4T-2/TXL1001
Ident no.	6630268

Connector A side	Connector, M12 - 1, Straight
Number of pins	4
Contacts	Brass, CuZn, Gold-plated
Contact carriers	Plastic, TPU, Black
Grip	Plastic, TPU, Black
Coupling nut/screw	Brass, CuZn, Nickel-plated
Protection class	IP67, A + B side screwed together
Mechanical lifespan	> 100 Mating cycles
Pollution degree	3
Tightening torque	0.8 ... 1 Nm (observe max. torque of counter piece!)

General data	
Cable diameter	5.3 ± 0.20mm
Cable length	2 m
Cable quality	PUR
Cable color	Black
Core insulation	PP
Core colors	BN, WH, BU, BK
Core cross-section	4x0.34mm ²
Arrangement of strands	42x0.1 mm

Electrical features at +20 °C	
Current	4 A
Rated voltage	250 V
Insulation resistance	> 30.5 MΩ/km
Test voltage	2000 V
Forward resistance	max. 57 Ω/km

Mechanical and chemical properties	
Max. tensile strength (static)	≤ 50 N/mm ²
Max. tensile strength (dynamic)	≤ 20 N/mm ²
Bending radius (stationary laying)	> 5 x Ø
Bending radius (flexible use)	> 10 x Ø
Ambient temperature	
Stationary	-50...+105°C
In motion	-30...+90°C

Cable Cross-section

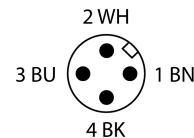
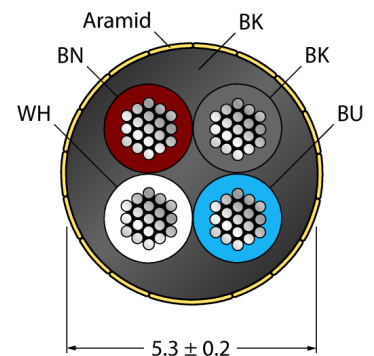

General information

Drawing depicts design version including hexagon coupling nut (Production date after CW11/2016).

Circuit Diagram

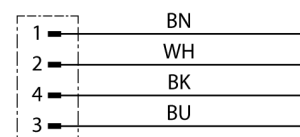



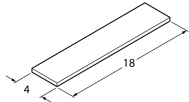
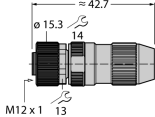
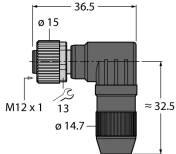
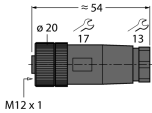

Weld-Splatter Resistant Actuator and Sensor Cable
Connection cable
RSC4.4T-2/TXL1001

Accessories

Type code	Ident no.	Description	
Torque-Wrench-Set-AS	6936170	Torque wrench set; handles with adjustable torque 0.4-1.0 Nm, torque wrench for M8 (SW9), fork wrench for M12 (SW 14)	
BLANK-LABEL-FOR-CORDSETS-TEL-TXL	6936206	Label for TEL and TXL cables, length: 18 mm, height: 4 mm, material: polycarbonate (PC), color: white, halogen-free and flame-retardant	
HA8141-0	6905407	Field-wireable female connector, M12 \leftarrow 1, straight, 4-pin, insulation piercing connection, cable feedthrough 4.0 to 5.1 mm, core cross-section/terminal capacity 0.14 to 0.34 mm ² , plastic housing, metal nut	
HA8241-0	6905401	Field-wireable female connector, M12 \leftarrow 1, angled, 4-pin, insulation piercing connection, cable feedthrough 4.0 to 5.1 mm, core cross-section/terminal capacity 0.14 to 0.34 mm ² , plastic housing, metal nut	
B8141-0	69049	Field-wireable female connector, M12 \leftarrow 1, straight, 4-pin, screw terminal connection, cable feedthrough 4.0 to 6.0 mm, core cross-section/terminal capacity 0.14 to 0.75 mm ² , plastic housing, plastic nut	

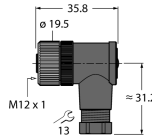
Weld-Splatter Resistant Actuator and Sensor Cable
Connection cable
RSC4.4T-2/TXL1001

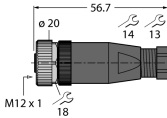
Accessories

Type code	Ident no.	Description	
B8241-0	69048	Field-wireable female connector, M12  , angled, 4-pin, screw terminal connection, cable feedthrough 4.0 to 6.0 mm, core cross-section/terminal capacity 0.14 to 0.75 mm ² , plastic housing, plastic nut	
BM8141-0	6935145	Field-wireable female connector, M12  , straight, 4-pin, screw terminal connection, cable feedthrough 4.0 to 6.0 mm, core cross-section/terminal capacity 0.25 to 0.75 mm ² , plastic housing, metal nut	
BM8241-0	6935889	Field-wireable female connector, M12  , angled, 4-pin, screw terminal connection, cable feedthrough 4.0 to 6.0 mm, core cross-section/terminal capacity 0.25 to 0.75 mm ² , plastic housing, metal nut	