

Description

The SMC30J Transil series has been designed to protect sensitive equipment against surges below 3000 W (10/1000 μ s) and against electro-static discharges according to IEC 61000-4-2, and MIL STD 883, method 3015.

The Planar technology makes it compatible with high-end equipment and SMPS where low leakage current and high junction temperature are required to provide reliability and stability over time. SMC30J are packaged in SMC (SMC footprint in accordance with IPC 7531 standard).

Features

- Peak pulse power:
 - 3000 W (10/1000 μ s)
- Stand off voltage range: from 5 V to 48 V
- Unidirectional and bidirectional types
- Low leakage current: 0.2 μ A
- Operating T_{jmax} : 175 °C
- JEDEC registered package outline

Complies with the following standards

- IEC 61000-4-2 exceeds level 4
 - 30 kV (air discharge)
 - 30 kV (contact discharge)
- **MIL STD 883G, method 3015-7 Class 3B**
 - 25 kV HBM (human body model)
- Resin meets UL 94, V0
- MIL-STD-750, method 2026 solderability
- EIA STD RS-481 and IEC 60286-3 packing
- IPC 7531 footprint

TM: Transil is a trademark of STMicroelectronics

1 Characteristics

Table 1. Absolute maximum ratings ($T_{amb} = 25\text{ }^{\circ}\text{C}$)

Symbol	Parameter	Value	Unit
P_{PP}	Peak pulse power dissipation T_j initial = T_{amb}	3000	W
T_{stg}	Storage temperature range	-65 to +175	$^{\circ}\text{C}$
T_j	Operating junction temperature range	-55 to +175	$^{\circ}\text{C}$
T_L	Maximum lead temperature for soldering during 10 s.	260	$^{\circ}\text{C}$

Table 2. Thermal resistances

Symbol	Parameter	Value	Unit
$R_{th(j-l)}$	Junction to leads	15	$^{\circ}\text{C/W}$

Figure 1. Electrical characteristics - definitions

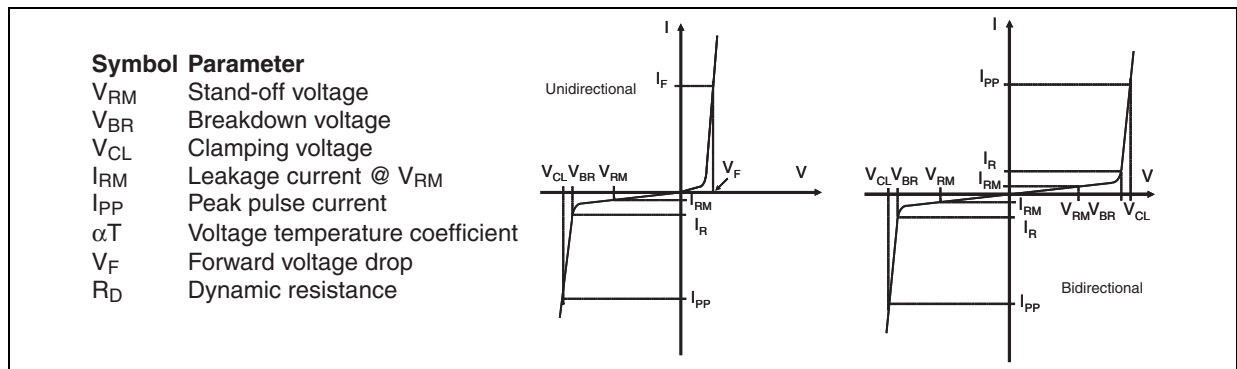

Figure 2. Pulse definition for electrical characteristics

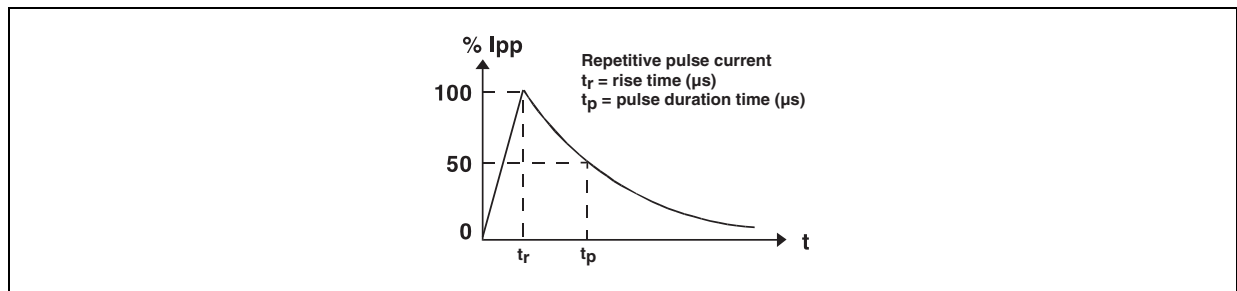

Table 3. Electrical characteristics - parameter values ($T_{amb} = 25\text{ °C}$)

Order code	$I_{RM\ max}@V_{RM}$		$V_{BR}\ @I_R^{(1)}$			$V_{CL}\ @I_{PP}\ 10/1000\ \mu s$		$R_D^{(2)}\ 10/1000\ \mu s$	$\alpha T^{(3)}$
			min	typ		max			
	μA	V	V		mA	V	A ⁽⁴⁾	Ω	10-4/ °C
SMC30J5.0A/CA	500	5	6.4	6.74	10	9.2	327	0.008	5.7
SMC30J6.0A/CA	500	6	6.7	7.05	10	10.3	291	0.011	5.9
SMC30J6.5A/CA	250	6.5	7.2	7.58	10	11.2	268	0.014	6.1
SMC30J8.5A/CA	10	8.5	9.4	9.9	1	14.4	208	0.022	7.3
SMC30J10A/CA	0.2	10	11.1	11.7	1	17	176	0.030	7.8
SMC30J12A/CA	0.2	12	13.3	14	1	19.9	151	0.039	8.3
SMC30J13A/CA	0.2	13	14.4	15.2	1	21.5	140	0.045	8.4
SMC30J15A/CA	0.2	15	16.7	17.6	1	24.4	123	0.055	8.8
SMC30J16A/CA	0.2	16	17.8	18.7	1	26	115	0.063	8.8
SMC30J18A/CA	0.2	18	20	21.1	1	29.2	103	0.079	9.2
SMC30J20A/CA	0.2	20	22.2	23.4	1	32.4	93	0.097	9.4
SMC30J22A/CA	0.2	22	24.4	25.7	1	35.5	85	0.115	9.6
SMC30J24A/CA	0.2	24	26.7	28.1	1	38.9	77	0.140	9.6
SMC30J26A/CA	0.2	26	28.9	30.4	1	42.1	71	0.165	9.7
SMC30J28A/CA	0.2	28	31.1	32.7	1	45.4	66	0.192	9.8
SMC30J30A/CA	0.2	30	33.3	35.1	1	48.4	62	0.215	9.9
SMC30J33A/CA	0.2	33	36.7	38.6	1	53.3	56	0.261	10.0
SMC30J36A/CA	0.2	36	40.0	42.1	1	58.1	48.41	0.331	10.0
SMC30J40A/CA	0.2	40	44.4	46.7	1	64.5	43.5	0.409	10.1
SMC30J48A/CA	0.2	48	53.2	56.0	1	76.6	38.0	0.542	10.3

1. Pulse test: $t_p < 50\ ms$

2. To calculate maximum clamping voltage at other surge level, use the following formula: $V_{CLmax} = V_{CL} - R_D \times (I_{PP} - I_{PPappli})$
where $I_{PPappli}$ is the surge current in the application

3. To calculate V_{BR} or V_{CL} versus junction temperature, use the following formulas:

$$V_{BR}\ @\ T_J = V_{BR}\ @\ 25\text{ °C} \times (1 + \alpha T \times (T_J - 25))$$

$$V_{CL}\ @\ T_J = V_{CL}\ @\ 25\text{ °C} \times (1 + \alpha T \times (T_J - 25))$$

4. Surge capability given for both directions for unidirectional and bidirectional types.

Figure 3. Peak pulse power dissipation versus initial junction temperature

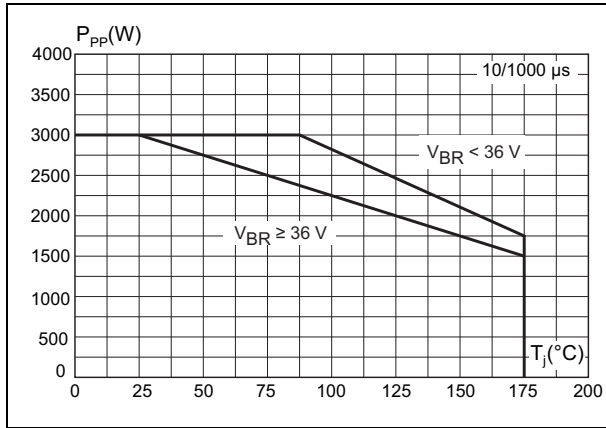

Figure 4. Peak pulse power versus exponential pulse duration (T_j initial = 25 °C)

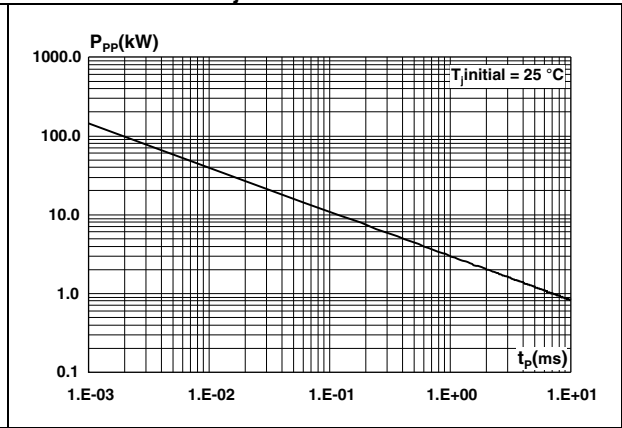

Figure 5. Clamping voltage versus peak pulse current (exponential waveform, maximum values)

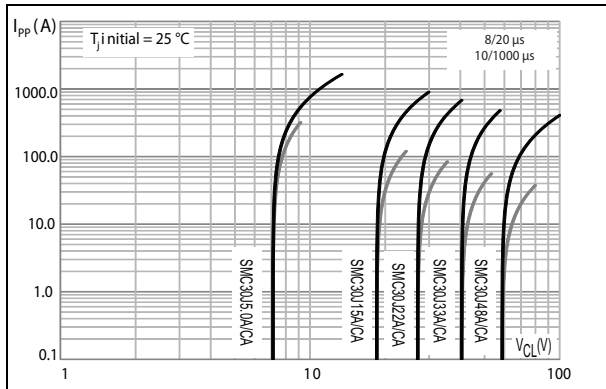

Figure 6. Junction capacitance versus reverse applied voltage for unidirectional types

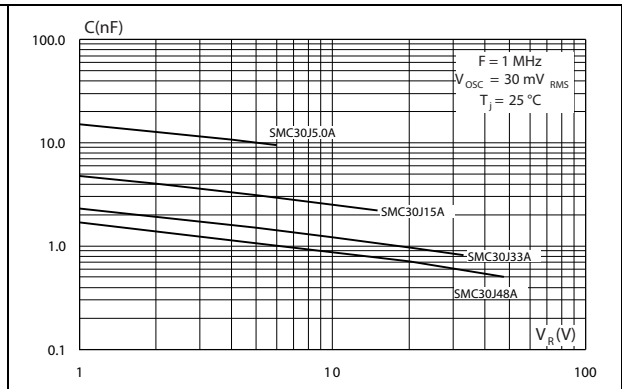

Figure 7. Junction capacitance versus reverse applied voltage for bidirectional types

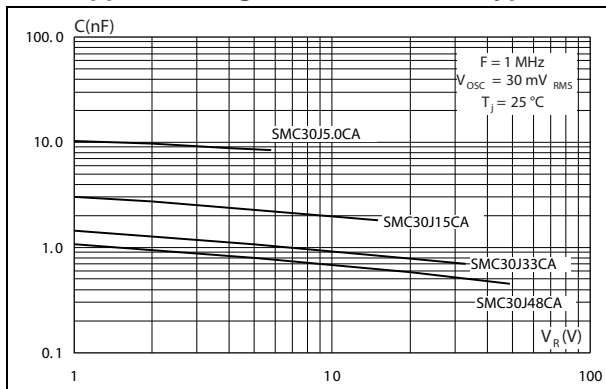

Figure 8. Peak forward voltage drop versus peak forward current

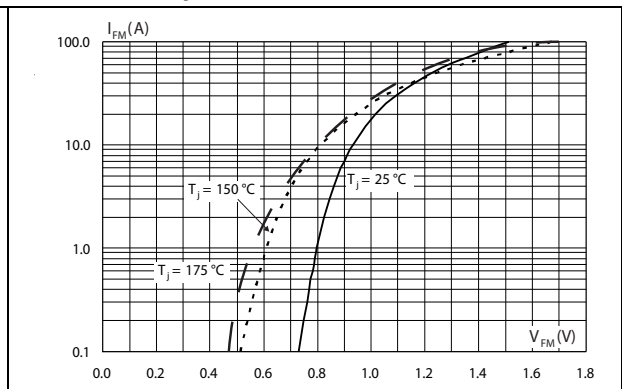

Figure 9. Relative variation of thermal impedance versus pulse duration

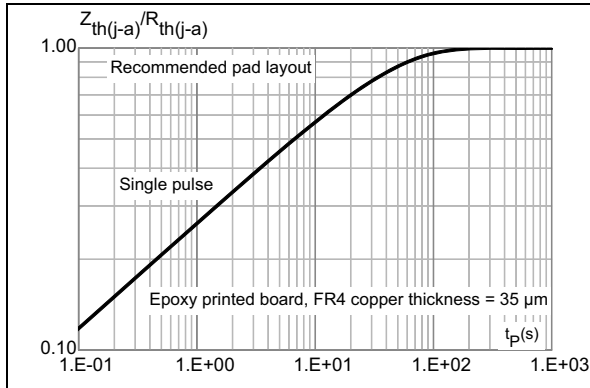

Figure 10. Thermal resistance junction to ambient versus copper surface under each lead

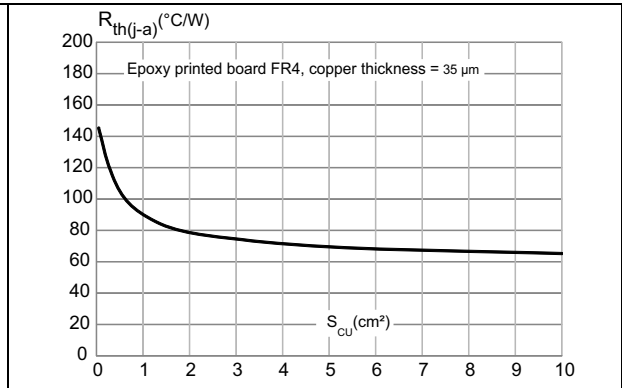
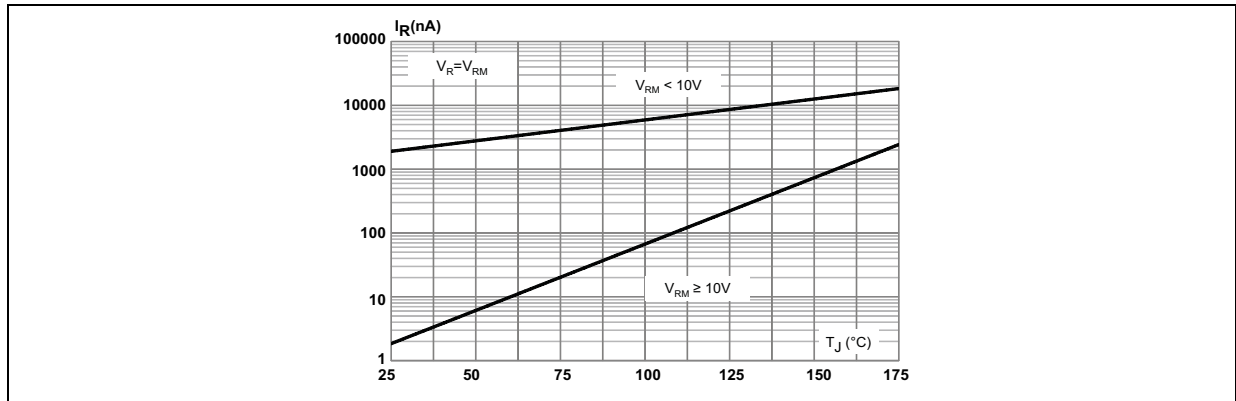
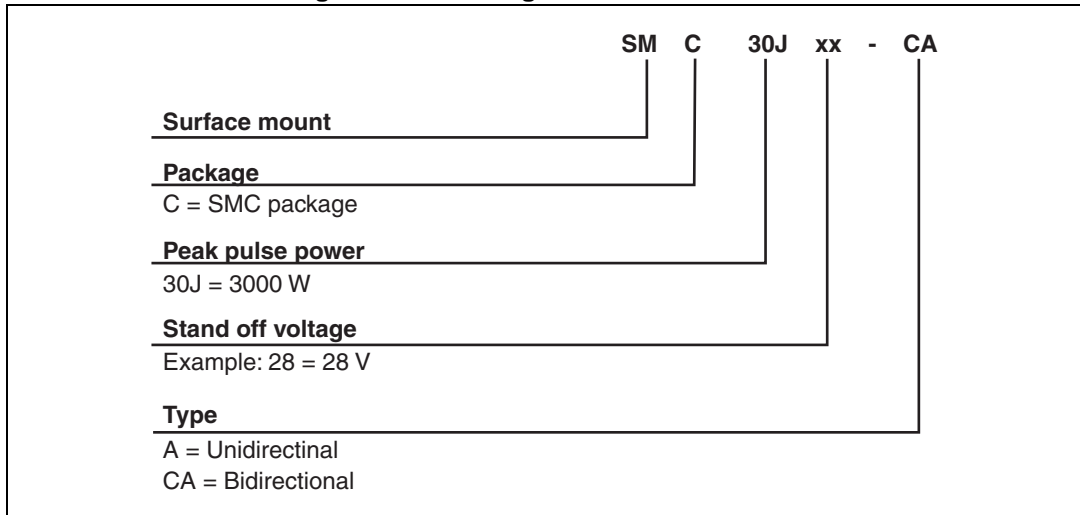

Figure 11. Leakage current versus junction temperature (typical values)



2 Ordering information scheme

Figure 12. Ordering information scheme



3 Package information

- Case: JEDEC DO-214AB molded plastic over planar junction
- Terminals: solder plated, solderable per MIL-STD-750, Method 2026
- Polarity: for unidirectional types the band indicates cathode
- Flammability: epoxy is rated UL94V-0
- RoHS package

In order to meet environmental requirements, ST offers these devices in different grades of ECOPACK® packages, depending on their level of environmental compliance. ECOPACK® specifications, grade definitions and product status are available at: www.st.com. ECOPACK® is an ST trademark.

Table 4. SMC package dimensions

Ref.	Dimensions			
	Millimeters		Inches	
	Min.	Max.	Min.	Max.
A1	1.90	2.45	0.075	0.096
A2	0.05	0.20	0.002	0.008
b	2.90	3.2	0.114	0.126
c	0.15	0.41	0.006	0.016
E	7.75	8.15	0.305	0.321
E1	6.60	7.15	0.260	0.281
E2	4.40	4.70	0.173	0.185
D	5.55	6.25	0.218	0.246
L	0.75	1.60	0.030	0.063

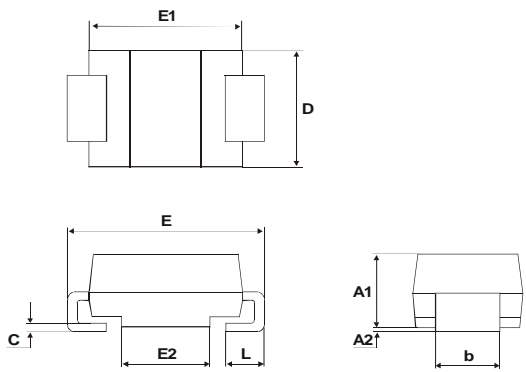
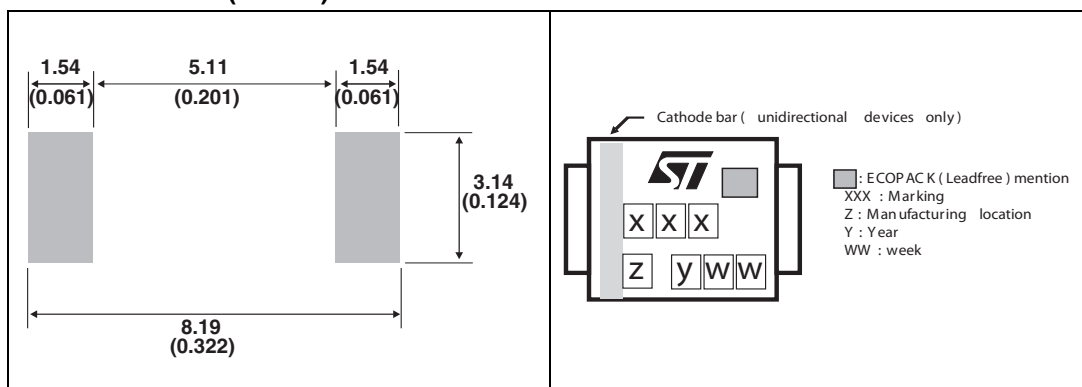

Figure 13. Footprint dimensions mm (inches)

Figure 14. Marking layout⁽¹⁾



1. Marking layout can vary according to assembly location.

Table 5. Marking

Order code	Marking	Order code	Marking
SMC30J5.0A	3AAA	SMC30J5.0CA	3BAA
SMC30J6.0A	3AAB	SMC30J6.0CA	3BAB
SMC30J6.5A	3AAC	SMC30J6.5CA	3BAC
SMC30J8.5A	3AAD	SMC30J8.5CA	3BAD
SMC30J10A	3AAW	SMC30J10CA	3BAW
SMC30J12A	3AAF	SMC30J12CA	3BAF
SMC30J13A	3AAG	SMC30J13CA	3BAG
SMC30J15A	3AAH	SMC30J15CA	3BAH
SMC30J16A	3AAI	SMC30J16CA	3BAI
SMC30J18A	3AAJ	SMC30J18CA	3BAJ
SMC30J20A	3AAK	SMC30J20CA	3BAK
SMC30J22A	3AAL	SMC30J22CA	3BAL
SMC30J24A	3AAE	SMC30J24CA	3BAE
SMC30J26A	3AAM	SMC30J26CA	3BAM
SMC30J28A	3AAN	SMC30J28CA	3BAN
SMC30J30A	3AAO	SMC30J30CA	3BAO
SMC30J33A	3AAP	SMC30J33CA	3BAP
SMC30J36A	3AAQ	SMC30J36CA	3BAQ
SMC30J40A	3AAR	SMC30J40CA	3BAR
SMC30J48A	3AAS	SMC30J48CA	3BAS

4 Ordering information

Table 6. Ordering information

Table 7.

Order code	Marking	Package	Weight	Base qty	Delivery mode
SMC30JxxxA/CA ⁽¹⁾	See Table 5 on page 8	SMC	0.25 g	2500	Tape and reel

1. Where xxx is nominal value of V_{BR} and A or CA indicates unidirectional or bidirectional version. See [Table 3](#) for list of available devices and their order codes

5 Revision history

Table 8. Document revision history

Date	Revision	Changes
28-Jul-2011	1	Initial release.
15-Jul-2015	2	Updated features on cover page. Updated Table 1 , Figure 3 , Figure 5 , Figure 6 , Figure 7 , Figure 8 , Figure 10 and Figure 11 . Updated Table 5 .
22-Jul-2015	3	Updated Figure 9 .

IMPORTANT NOTICE – PLEASE READ CAREFULLY

STMicroelectronics NV and its subsidiaries (“ST”) reserve the right to make changes, corrections, enhancements, modifications, and improvements to ST products and/or to this document at any time without notice. Purchasers should obtain the latest relevant information on ST products before placing orders. ST products are sold pursuant to ST’s terms and conditions of sale in place at the time of order acknowledgement.

Purchasers are solely responsible for the choice, selection, and use of ST products and ST assumes no liability for application assistance or the design of Purchasers’ products.

No license, express or implied, to any intellectual property right is granted by ST herein.

Resale of ST products with provisions different from the information set forth herein shall void any warranty granted by ST for such product.

ST and the ST logo are trademarks of ST. All other product or service names are the property of their respective owners.

Information in this document supersedes and replaces information previously supplied in any prior versions of this document.

© 2015 STMicroelectronics – All rights reserved