

Schottky Barrier Diode

multicomp^{PRO}

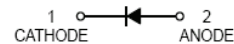
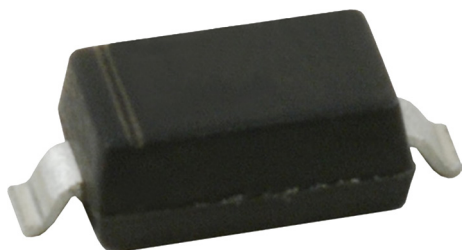

SOD-123

Features:

- Low Forward Voltage Drop
- Guard Ring Construction For Transient Protection
- High Conductance

Applications:

- 0.5A surface mount schottky barrier rectifier

Maximum Ratings:

T_A = 25°C unless otherwise specified.

Characteristic	Symbol	Value	Unit
Peak repetitive reverse voltage Working peak reverse voltage DC reverse voltage	V _{RRM} V _{RWM} V _R	40	V
RMS reverse voltage	V _{R(RMS)}	28	V
Average rectified output current at T _L = 100°C	I _o	0.5	A
Non-Repetitive peak forward surge current 8.3Ms single half sine-wave superimposed on rated load	I _{FSM}	5.5	A
Power dissipation	P _D	410	mW
Thermal resistance junction to ambient	R _{θJA}	244	°C/W
Operating and storage temperature range	T _J , T _{STG}	-65 to+125	°C
Voltage rate of change	dv/dt	1,000	V/μs

Newark.com/multicomp-pro
Farnell.com/multicomp-pro
Element14.com/multicomp-pro

multicomp^{PRO}

Electrical Characteristics:

T_A = 25°C unless otherwise specified.

Characteristic	Symbol	B0540W-7-F	Unit	Test Conditions
Minimum reverse Breakdown voltage	V _{(BR)R}	- - 40	V	I _R = 250μA I _R = 130μA I _R = 20μA
Maximum forward voltage drop	V _{FM}	- 0.51 0.62 - 0.46 0.61	V	I _F =0.1A, T _j =25°C I _F =0.5A, T _j =25°C I _F =1.0A, T _j =25°C I _F =0.1A, T _j =100°C I _F =0.5A, T _j =100°C I _F =1.0A, T _j =100°C
Maximum leakage current	I _{RM}	- - 10 - 20	μA	V _R =10V, T _j =25°C V _R =15V, T _j =25°C V _R =20V, T _j =25°C V _R =30V, T _j =25°C V _R =40V, T _j =25°C
		- 5.0 13	mA	V _R =10V, T _j =100°C V _R =20V, T _j =100°C V _R =40V, T _j =100°C
Junction capacitance	C _J	170	pF	f=1MHz, V _R =0V DC

Typical Characteristics:

T_A = 25°C unless otherwise specified.

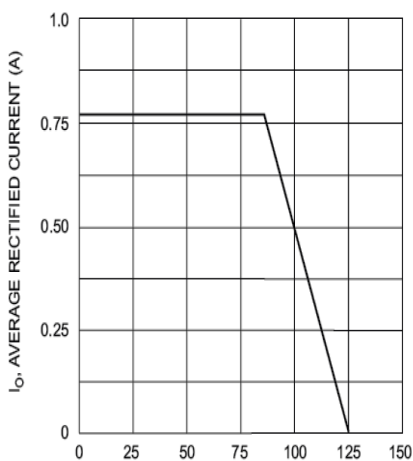

Fig. 1 Forward Current Derating Curve

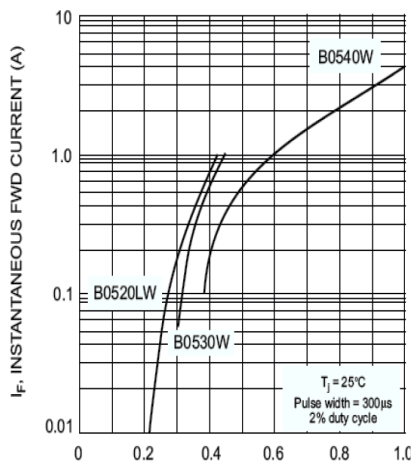

Fig. 2 Typical Forward Characteristics

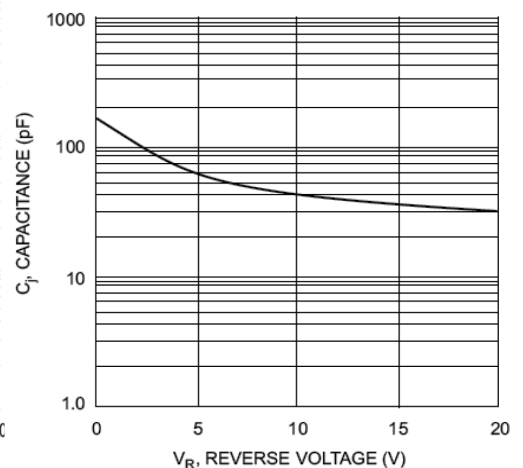
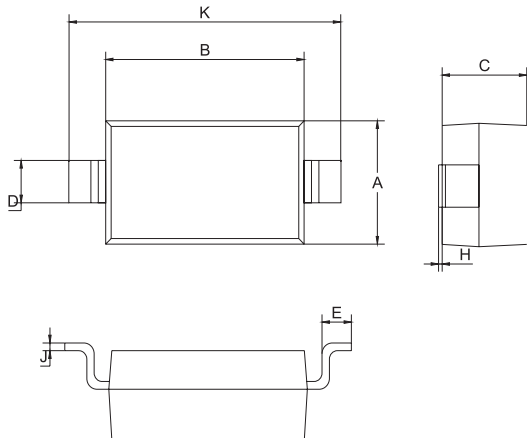

Fig. 3 Typ. Junction Capacitance vs Reverse Voltage

Package Outline:

Plastic surface mounted package



SOD-123		
Dim.	Min.	Max.
A	1.4	1.8
B	2.55	2.85
C	1.15 Typ.	
D	0.5	0.6
E	0.3	0.4
H	0.02	0.1
J	0.1 Typ.	
K	3.55	3.85

Dimensions : Millimetres

Soldering Footprint:

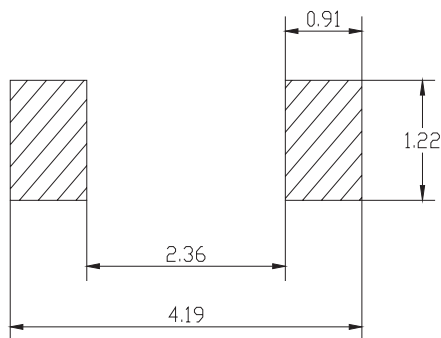

Dimensions : Millimetres

Package Information:

Device	Package	Shipping
B0540W-7-F	SOD-123	3,000 / Tape & Reel

Part Number Table

Description	Part Number
Schottky Barrier Diode	B0540W-7-F

Important Notice : This data sheet and its contents (the "Information") belong to the members of the AVNET group of companies (the "Group") or are licensed to it. No licence is granted for the use of it other than for information purposes in connection with the products to which it relates. No licence of any intellectual property rights is granted. The Information is subject to change without notice and replaces all data sheets previously supplied. The Information supplied is believed to be accurate but the Group assumes no responsibility for its accuracy or completeness, any error in or omission from it or for any use made of it. Users of this data sheet should check for themselves the Information and the suitability of the products for their purpose and not make any assumptions based on information included or omitted. Liability for loss or damage resulting from any reliance on the Information or use of it (including liability resulting from negligence or where the Group was aware of the possibility of such loss or damage arising) is excluded. This will not operate to limit or restrict the Group's liability for death or personal injury resulting from its negligence. Multicomp Pro is the registered trademark of Premier Farnell Limited 2019.