

PTS525 Series Microminiature Tact Switch for SMT

Features/Benefits

- 0.8 & 1.5 mm actuator height
- Ruggedized package in a compact size
- High number of cycles

Typical Applications

- Consumer products
- Instrumentation
- Remote controls



B

Tactile Switches

Specification

FUNCTION: Momentary action
CONTACT ARRANGEMENT: 1 make contact = SPST, N.O.

Electrical

MAXIMUM VOLTAGE: 15 VDC
MAXIMUM CURRENT DC: 20 mA
DIELECTRIC STRENGTH: 250 VA C (1mn)
CONTACT RESISTANCE: $\leq 100 \text{ m}\Omega$
INSULATION RESISTANCE: $\geq 100 \text{ M}\Omega$
BOUNCE TIME: $\leq 10 \text{ ms}$

Environmental

OPERATING TEMPERATURE: -20°C to 70°C

Process

SOLDERING: This component is suited to the following methods:
Infrared Reflow Soldering in accordance with IEC61760-1

Packaging

Switches in reels of:
5,000 pieces in 0.8 mm height
4,000 pieces in 1.5 mm height
Dimensions of reels according to EIA 481B
External diameter 330 mm

NOTE:

- Specifications listed above are for switches with standard options. For information on specific and custom switches, consult Customer Service Center.
- The PTS series is not certified for using in Automotive application and no PPAP. However, in the case of some automotive accessories and specific applications for 2 and 3 wheeled vehicles the PTS is widely used and very suitable. Please contact your local C&K representative to discuss your application and the best switch solution.

How To Order

Please see chart below for full part numbers.

Part Number	Height (mm)	Leads Shape	Ground Pin	Force	Travel (mm)	Operating Life
PTS525 SM08 SMTR 2 LFS	0.8	G	No	160 gf \pm 50 gf	0.25 \pm 0.2	1,000,000
PTS525 SK08 SMTR 2 LFS	0.8	G	No	260 gf \pm 50 gf	0.25 \pm 0.2	200,000
PTS525 SM15 SMTR 2 LFS	1.5	G	No	160 gf \pm 50 gf	0.25 \pm 0.2	1,000,000
PTS525 SK15 SMTR 2 LFS	1.5	G	No	260 gf \pm 50 gf	0.25 \pm 0.2	500,000
PTS525 SMG15 SMTR 2 LFS	1.5	G	Yes	160 gf \pm 50 gf	0.25 \pm 0.2	1,000,000
PTS525 SKG15 SMTR 2 LFS	1.5	G	Yes	260 gf \pm 50 gf	0.25 \pm 0.2	500,000
PTS525 SMG15J SMTR 2 LFS	1.5	J	Yes	160 gf \pm 50 gf	0.25 \pm 0.2	1,000,000
PTS525 SKG15J SMTR 2 LFS	1.5	J	Yes	260 gf \pm 50 gf	0.25 \pm 0.2	500,000

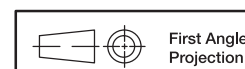

First Angle
Projection

Dimensions are shown: mm

Specifications and dimensions subject to change



PTS525 Series Microminiature Tact Switch for SMT

PTS525 SM08 SMTR2 LFS
PTS525 SK08 SMTR2 LFS

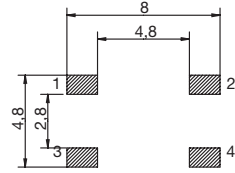
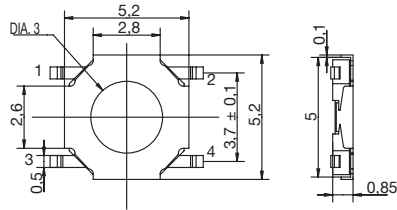
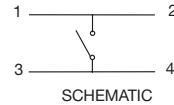
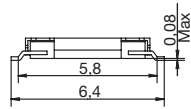

RECOMMENDED PCB LAYOUT

PTS525 SM15 SMTR2 LFS
PTS525 SK15 SMTR2 LFS

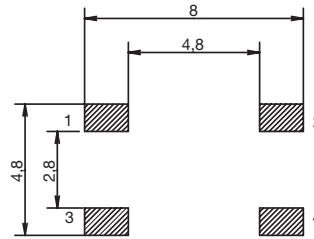
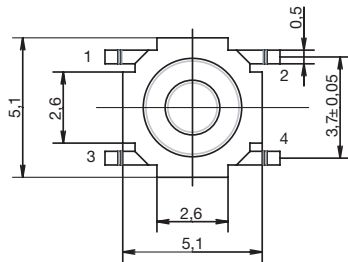
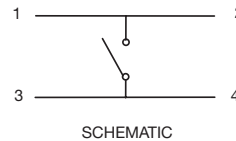
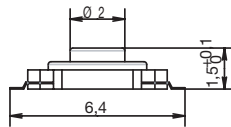

RECOMMENDED PCB LAYOUT

PTS525 SMG15 SMTR2 LFS
PTS525 SKG15 SMTR2 LFS

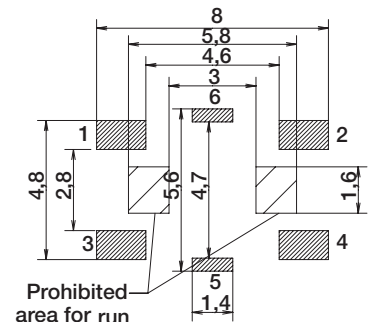
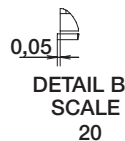
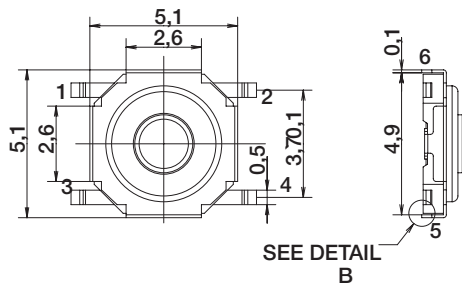
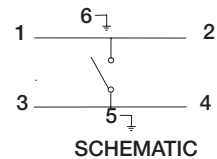
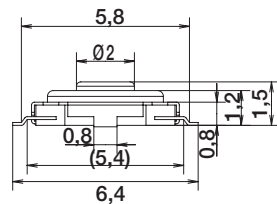

RECOMMENDED PCB LAYOUT



Tactile Switches

B

PTS525 Series Microminiature Tact Switch for SMT

PTS525 SMG15J SMTR2 LFS
PTS525 SKG15J SMTR2 LFS

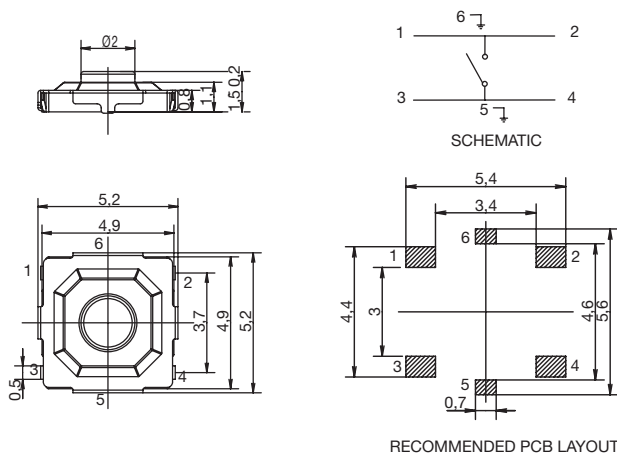

B
Tactile Switches

TAPE & REEL

0.8 mm height
5,000 pieces per reel

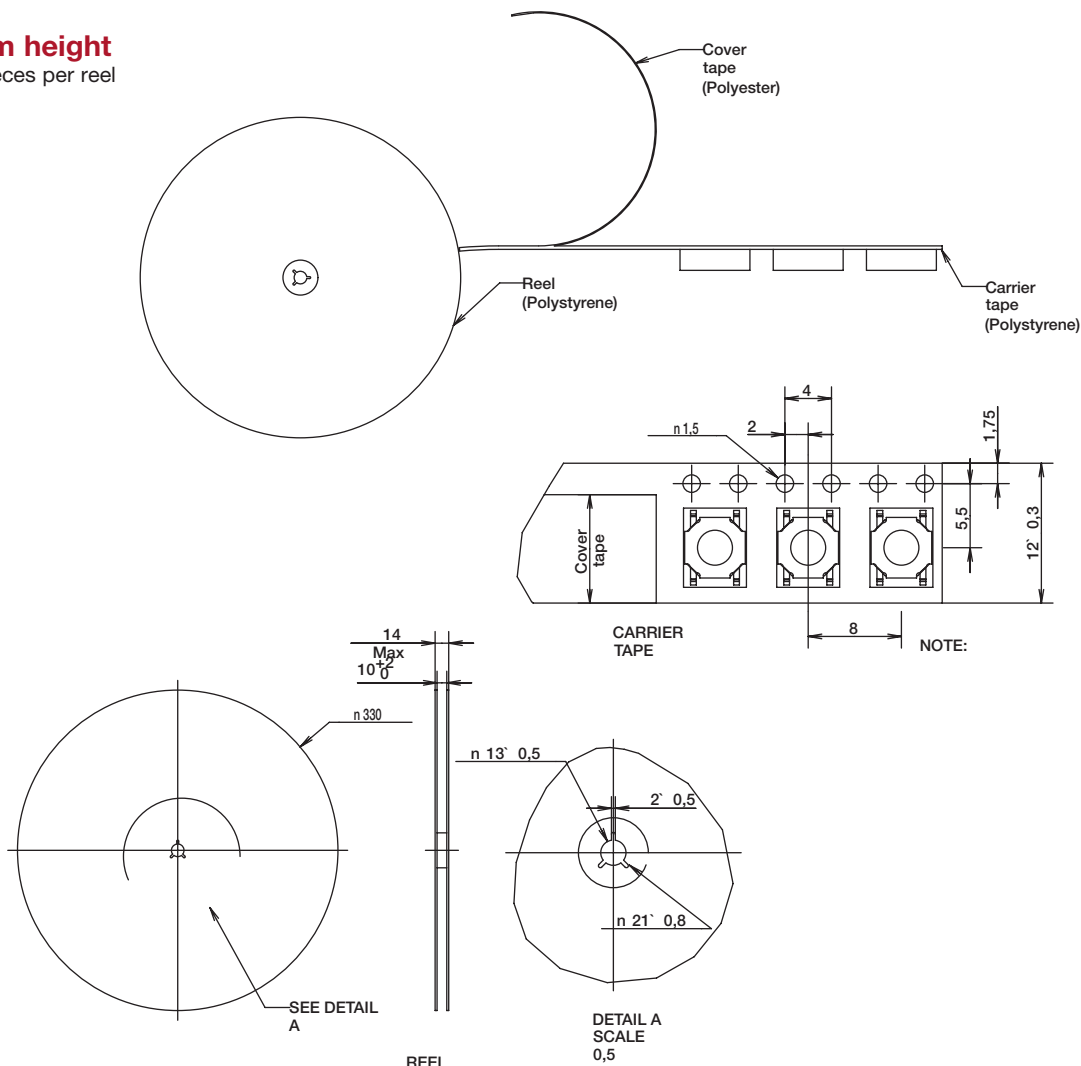

PTS525 Series Microminiature Tact Switch for SMT

TAPE & REEL

1.5 mm height
4,000 pieces per reel

Tactile Switches

B

