

Fiche technique | Numéro d'article: 280-558

Borne à trois étages; Borne de raccordement de tresse de blindage / de passage / passage; avec support de marquage avec; Pour rail 35 x 15 et 35 x 7,5; 2,5 mm²; CAGE CLAMP®

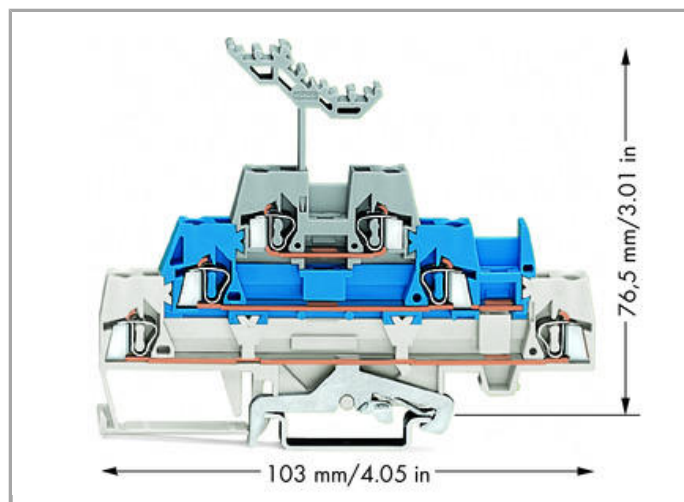

www.wago.com/280-558



RoHS Compliant [BOMcheck.net](https://www.bomcheck.net)

Données

Données électriques

Ratings per IEC/EN 60664-1

Tension de référence (III / 3)	500 V
Tension assignée de tenue aux chocs (III / 3)	6 kV
Courant	20 A
Légende Données de référence	(III / 3) ≙ Catégorie de surtension III / degré de pollution 3

Données de raccordement

Technique de connexion	CAGE CLAMP®
Type d'actionnement	Outil de manipulation
Matière plastique conducteur raccordable	Cuivre aluminium
Conducteur rigide	0,08 ... 2,5 mm ² / 28 ... 12 AWG
Conducteur souple	0,08 ... 2,5 mm ² / 28 ... 12 AWG
Longueur de dénudage	8 ... 9 mm / 0.31 ... 0.35 inch

Nombre total des points de serrage	6
Nombre total des potentiels	3
nombre des niveaux	3
Type de câblage	câblage frontal

Données géométriques

Largeur	5 mm / 0.197 inch
Profondeur à partir du niveau supérieur du rail	76,5 mm / 3.012 inch
Profondeur	103 mm / 4.055 inch

Données mécaniques

Mode de construction	type horizontal
Type de montage	Rail 35
Niveau de marquage	Marquage central

Données du matériau

Couleur	blanc/bleu/gris
Matière isolante	Polyamide 66 (PA 66)
Charge calorifique	0.279 MJ
Poids	21.724 g

Dates commerciales

Country of origin	DE
GTIN	4045454093181
Customs Tariff No.	85369010000
Product Group	1 (Rail Mounted Terminal Blocks)

Autorisations / certificats

Approbations spécifiques au pays

Logo	Approbation	Nom du certificat
	CCA DEKRA Certification B.V.	2157201.01

Approbations de navire

Logo	Approbation	Nom du certificat
	ABS American Bureau of Shipping	14-HG1293677-PDA



BV
Bureau Veritas S.A.

07436/E0 BV



LR
Lloyds Register

91/20112 (E9)

Approbations UL

Logo	Approbation	Nom du certificat
	<p>UR Underwriters Laboratories Inc.</p>	E45172

Produits correspondants

assembling



N° art.: 209-106
Pied de montage; pour le montage isolé des rails DIN35

www.wago.com/209-106

N° art.: 709-154
Profil de recouvrement; typ. 2; approprié au support pour capot type 2; longueur 1 m

www.wago.com/709-154

Protective Warning Marker



N° art.: 280-415
Obtrateur de protection avec signalisation de danger; avec signalisation de danger; pour 5 bornes

www.wago.com/280-415

tools



N° art.: 210-657
Outil de manipulation, partiellement isolé; Lame (3,5 x 0,5) mm; court

www.wago.com/210-657

N° art.: 210-658
Outil de manipulation, partiellement isolé; Lame (3,5 x 0,5) mm; court; Coudé

www.wago.com/210-658

N° art.: 210-720
Outil de manipulation, partiellement isolé; Type 2, lame (3,5 x 0,5) mm

www.wago.com/210-720

Jumper



N° art.: 210-103
Chaîne de pontage en fil; isolé; 50 raccords

www.wago.com/210-103















N° art.: 210-123
Chaîne de pontage en fil; isolé; 50 raccords

















www.wago.com/210-123

N° art.: 249-123
Conducteurs de pontage enfichables; isolé; L = 180 mm; Section du conducteur 0,75 mm²

www.wago.com/249-123

N° art.: 249-125

	Conducteurs de pontage enfichables; isolé; L = 60 mm; Section du conducteur 0,75 mm ²	www.wago.com/249-125
	N° art.: 249-126 Conducteurs de pontage enfichables; isolé; L = 110 mm; Section du conducteur 0,75 mm ²	www.wago.com/249-126
	N° art.: 249-127 Conducteurs de pontage enfichables; isolé; L = 250 mm; Section du conducteur 0,75 mm ²	www.wago.com/249-127
	N° art.: 280-402 Contact de pontage horizontal; isolé; IN = IN borne	www.wago.com/280-402
	N° art.: 280-409 Contact de pontage alternant; isolé; IN = IN borne	www.wago.com/280-409
	N° art.: 280-482 Peigne de pontage; isolé; 2 raccords; IN = IN borne	www.wago.com/280-482
	N° art.: 280-483 Peigne de pontage; isolé; 3 raccords; IN = IN borne	www.wago.com/280-483
	N° art.: 280-484 Peigne de pontage; isolé; 4 raccords; IN = IN borne	www.wago.com/280-484
	N° art.: 280-485 Peigne de pontage; isolé; 5 raccords; IN = IN borne	www.wago.com/280-485
	N° art.: 280-490 Peigne de pontage; isolé; 10 raccords; IN = IN borne	www.wago.com/280-490
	N° art.: 280-492 Peigne de pontage alternant; isolé; 2 raccords; IN = IN borne	www.wago.com/280-492
	N° art.: 281-421 Contact de pontage vertical; isolé; Courant nominal 24 A	www.wago.com/281-421
	N° art.: 709-110 Chaîne de pontage en fil; isolé; 4 raccords; 3 x 110	www.wago.com/709-110
	N° art.: 709-111 Chaîne de pontage en fil; isolé; 3 raccords; 2 x 120	www.wago.com/709-111
	N° art.: 709-112 Chaîne de pontage en fil; isolé; 3 raccords; 2 x 170	www.wago.com/709-112
	N° art.: 780-452 Ponts intercalables; isolé; de 1 à 2; Pas 5 mm; approprié pour connecteurs femelles pour 2 conducteurs	www.wago.com/780-452
	N° art.: 780-453 Ponts intercalables; isolé; de 1 à 3; Pas 5 mm; approprié pour connecteurs femelles pour 2 conducteurs	www.wago.com/780-453
	N° art.: 780-454 Ponts intercalables; isolé; de 1 à 4; Pas 5 mm; approprié pour connecteurs femelles pour 2 conducteurs	www.wago.com/780-454
	N° art.: 780-455 Ponts intercalables; isolé; de 1 à 5; Pas 5 mm; approprié pour connecteurs femelles pour 2 conducteurs	www.wago.com/780-455
	N° art.: 780-456	

	Ponts intercalables; isolé; de 1 à 6; Pas 5 mm; approprié pour connecteurs femelles pour 2 conducteurs	www.wago.com/780-456
	N° art.: 780-457 Ponts intercalables; isolé; de 1 à 7; Pas 5 mm; approprié pour connecteurs femelles pour 2 conducteurs	www.wago.com/780-457
	N° art.: 780-458 Ponts intercalables; isolé; de 1 à 8; Pas 5 mm; approprié pour connecteurs femelles pour 2 conducteurs	www.wago.com/780-458
check		
	N° art.: 249-141 Module de fiche de contrôle type L; modulaires; avec broche de contact à ressort; Module central	www.wago.com/249-141
Insulation stop		
	N° art.: 280-470 Réducteur isolant de sécurité; 0,08 - 0,2 mm ² « r » (0,14 mm ² « s »); 5 pièces/bande	www.wago.com/280-470
	N° art.: 280-471 Réducteur isolant de sécurité; 0,25 - 0,5 mm ² ; 5 pièces/bande	www.wago.com/280-471
	N° art.: 280-472 Réducteur isolant de sécurité; 0,75 - 1 mm ² ; 5 pièces/bande	www.wago.com/280-472
Carrier rail		
	N° art.: 210-112 Rail acier; 35 x 7,5; épaisseur 1 mm; longueur 2 m; perforé; d'après EN 60715; Largeur de trou 25 mm; pas des trous 36 mm	www.wago.com/210-112
	N° art.: 210-113 Rail acier; 35 x 7,5; épaisseur 1 mm; longueur 2 m; non perforé; d'après EN 60715	www.wago.com/210-113
	N° art.: 210-114 Rail acier; 35 x 15; épaisseur 1,5 mm; longueur 2 m; non perforé; d'après EN 60715	www.wago.com/210-114
	N° art.: 210-115 Rail acier; 35 x 7,5; épaisseur 1 mm; longueur 2 m; perforé; d'après EN 60715; Largeur de trou 18 mm; pas des trous 25 mm	www.wago.com/210-115
	N° art.: 210-118 Rail acier; 35 x 15; épaisseur 2,3 mm; longueur 2 m; non perforé; d'après EN 60715	www.wago.com/210-118
	N° art.: 210-196 Rail aluminium; 35 x 8,2; épaisseur 1,6 mm; longueur 2 m; non perforé; d'après EN 60715	www.wago.com/210-196
	N° art.: 210-197 Rail acier; 35 x 15; épaisseur 1,5 mm; longueur 2 m; perforé; d'après EN 60715	www.wago.com/210-197
	N° art.: 210-198 Rail en cuivre; 35 x 15; épaisseur 2,3 mm; longueur 2 m; non perforé; d'après EN 60715	www.wago.com/210-198
	N° art.: 210-504 Rail acier; 35 x 7,5; épaisseur 1 mm; longueur 2 m; perforé; galvanisation de bandes; d'après EN 60715	www.wago.com/210-504
	N° art.: 210-505 Rail acier; 35 x 7,5; épaisseur 1 mm; longueur 2 m; non perforé; galvanisation de bandes; d'après EN 60715	www.wago.com/210-505

	N° art.: 210-506 Rail acier; 35 x 15; épaisseur 1,5 mm; longueur 2 m; non perforé; galvanisation de bandes; d'après EN 60715	www.wago.com/210-506
--	--	--

	N° art.: 210-508 Rail acier; 35 x 15; épaisseur 1,5 mm; longueur 2 m; perforé; galvanisation de bandes; d'après EN 60715	www.wago.com/210-508
--	--	--

End plate

	N° art.: 280-303 Plaque d'extrémité et intermédiaire; épaisseur 2,5 mm	www.wago.com/280-303
--	--	--

	N° art.: 280-304 Plaque d'extrémité et intermédiaire; épaisseur 2,5 mm	www.wago.com/280-304
--	--	--

	N° art.: 280-336 Plaque intercalaire; épaisseur 1,1 mm	www.wago.com/280-336
--	--	--

Marking accessories

	N° art.: 2009-115 WMB-Inline; pour smartPRINTER; sur rouleau; extensible 5 - 5,2 MM; vierge; encliquetable	www.wago.com/2009-115
--	--	--

	N° art.: 2009-115/000-002 WMB-Inline; pour smartPRINTER; sur rouleau; extensible 5 - 5,2 MM; vierge; encliquetable	www.wago.com/2009-115/000-002
--	--	--

	N° art.: 2009-115/000-006 WMB-Inline; pour smartPRINTER; sur rouleau; extensible 5 - 5,2 MM; vierge; encliquetable	www.wago.com/2009-115/000-006
--	--	--

	N° art.: 2009-115/000-007 WMB-Inline; sur rouleau; extensible 5 - 5,2 MM; vierge; encliquetable	www.wago.com/2009-115/000-007
--	---	--

	N° art.: 2009-115/000-012 WMB-Inline; pour smartPRINTER; sur rouleau; extensible 5 - 5,2 MM; vierge; encliquetable	www.wago.com/2009-115/000-012
--	--	--

	N° art.: 2009-115/000-017 WMB-Inline; sur rouleau; extensible 5 - 5,2 MM; vierge; encliquetable	www.wago.com/2009-115/000-017
--	---	--

	N° art.: 2009-115/000-023 WMB-Inline; pour smartPRINTER; sur rouleau; extensible 5 - 5,2 MM; vierge; encliquetable	www.wago.com/2009-115/000-023
--	--	--

	N° art.: 2009-115/000-024 WMB-Inline; pour smartPRINTER; sur rouleau; extensible 5 - 5,2 MM; vierge; encliquetable	www.wago.com/2009-115/000-024
--	--	--

	N° art.: 793-501 Carte de repérage WMB; en carte; non extensible; vierge; encliquetable	www.wago.com/793-501
--	---	--

	N° art.: 793-501/000-002 Carte de repérage WMB; en carte; non extensible; vierge; encliquetable	www.wago.com/793-501/000-002
--	---	--



N° art.: 793-501/000-005
Carte de repérage WMB; en carte; non extensible; vierge; encliquetable

www.wago.com/793-501/000-005



N° art.: 793-501/000-006
Carte de repérage WMB; en carte; non extensible; vierge; encliquetable

www.wago.com/793-501/000-006



N° art.: 793-501/000-007
Carte de repérage WMB; en carte; non extensible; vierge; encliquetable

www.wago.com/793-501/000-007



N° art.: 793-501/000-012
Carte de repérage WMB; en carte; non extensible; vierge; encliquetable

www.wago.com/793-501/000-012



N° art.: 793-501/000-017
Carte de repérage WMB; en carte; non extensible; vierge; encliquetable

www.wago.com/793-501/000-017



N° art.: 793-501/000-023
Carte de repérage WMB; en carte; non extensible; vierge; encliquetable

www.wago.com/793-501/000-023



N° art.: 793-501/000-024
Carte de repérage WMB; en carte; non extensible; vierge; encliquetable

www.wago.com/793-501/000-024



N° art.: 793-5501
Carte de repérage WMB; en carte; largeur des bornes 5 - 17,5 mm; extensible 5 - 5,2 MM; vierge; encliquetable

www.wago.com/793-5501



N° art.: 793-5501/000-002
Carte de repérage WMB; en carte; largeur des bornes 5 - 17,5 mm; extensible 5 - 5,2 MM; vierge; encliquetable

www.wago.com/793-5501/000-002



N° art.: 793-5501/000-005
Carte de repérage WMB; en carte; extensible 5 - 5,2 MM; vierge; encliquetable

www.wago.com/793-5501/000-005



N° art.: 793-5501/000-006
Carte de repérage WMB; en carte; extensible 5 - 5,2 MM; vierge; encliquetable

www.wago.com/793-5501/000-006



N° art.: 793-5501/000-007
Carte de repérage WMB; en carte; extensible 5 - 5,2 MM; vierge; encliquetable

www.wago.com/793-5501/000-007



N° art.: 793-5501/000-012
Carte de repérage WMB; en carte; extensible 5 - 5,2 MM; vierge; encliquetable

www.wago.com/793-5501/000-012



N° art.: 793-5501/000-017
Carte de repérage WMB; en carte; extensible 5 - 5,2 MM; vierge; encliquetable

www.wago.com/793-5501/000-017



N° art.: 793-5501/000-023
Carte de repérage WMB; en carte; extensible 5 - 5,2 MM; vierge; encliquetable

www.wago.com/793-5501/000-023



N° art.: 793-5501/000-024





Carte de repérage WMB; en carte; extensible 5 - 5,2 MM; vierge; encliquetable















www.wago.com/793-5501/000-024







ferrule

	N° art.: 216-101 Embout d'extrémité; embout pour 0,5 mm ² / AWG 22; sans isolation plastique; étamés par électrolyse	www.wago.com/216-101
	N° art.: 216-102 Embout d'extrémité; embout pour 0,75 mm ² / AWG 20; sans isolation plastique; étamés par électrolyse	www.wago.com/216-102
	N° art.: 216-103 Embout d'extrémité; embout pour 1 mm ² / AWG 18; sans isolation plastique; étamés par électrolyse	www.wago.com/216-103
	N° art.: 216-104 Embout d'extrémité; embout pour 1,5 mm ² / AWG 16; sans isolation plastique; étamés par électrolyse	www.wago.com/216-104
	N° art.: 216-201 Embout d'extrémité; embout pour 0,5 mm ² / AWG 22; avec isolation plastique; étamés par électrolyse	www.wago.com/216-201
	N° art.: 216-202 Embout d'extrémité; embout pour 0,75 mm ² / AWG 20; avec isolation plastique; étamés par électrolyse	www.wago.com/216-202
	N° art.: 216-203 Embout d'extrémité; embout pour 1 mm ² / AWG 18; avec isolation plastique; étamés par électrolyse	www.wago.com/216-203
	N° art.: 216-204 Embout d'extrémité; embout pour 1,5 mm ² / AWG 16; avec isolation plastique; étamés par électrolyse	www.wago.com/216-204
	N° art.: 216-301 Embout d'extrémité; embout pour 0,25 mm ² / AWG 24; avec isolation plastique; étamés par électrolyse	www.wago.com/216-301
	N° art.: 216-302 Embout d'extrémité; embout pour 0,34 mm ² / AWG 24; avec isolation plastique; étamés par électrolyse	www.wago.com/216-302

General accessories

	N° art.: 231-162/003-000 Male connector for rail-mount terminal blocks; 1.2 x 1.2 mm pins; Droit; Pas 5 mm; 2 pôles	www.wago.com/231-162/003-000
	N° art.: 231-163/003-000 Male connector for rail-mount terminal blocks; 1.2 x 1.2 mm pins; Droit; Pas 5 mm; 3 pôles	www.wago.com/231-163/003-000
	N° art.: 231-164/003-000 Male connector for rail-mount terminal blocks; 1.2 x 1.2 mm pins; Droit; Pas 5 mm; 4 pôles	www.wago.com/231-164/003-000
	N° art.: 231-165/003-000 Male connector for rail-mount terminal blocks; 1.2 x 1.2 mm pins; Droit; Pas 5 mm; 5 pôles	www.wago.com/231-165/003-000
	N° art.: 231-166/003-000 Male connector for rail-mount terminal blocks; 1.2 x 1.2 mm pins; Droit; Pas 5 mm; 6 pôles	www.wago.com/231-166/003-000

	N° art.: 231-167/003-000 Male connector for rail-mount terminal blocks; 1.2 x 1.2 mm pins; Droit; Pas 5 mm; 7 pôles	www.wago.com/231-167/003-000
	N° art.: 231-168/003-000 Male connector for rail-mount terminal blocks; 1.2 x 1.2 mm pins; Droit; Pas 5 mm; 8 pôles	www.wago.com/231-168/003-000
	N° art.: 231-169/003-000 Male connector for rail-mount terminal blocks; 1.2 x 1.2 mm pins; Droit; Pas 5 mm; 9 pôles	www.wago.com/231-169/003-000
	N° art.: 231-170/003-000 Male connector for rail-mount terminal blocks; 1.2 x 1.2 mm pins; Droit; Pas 5 mm; 10 pôles	www.wago.com/231-170/003-000
	N° art.: 231-171/003-000 Male connector for rail-mount terminal blocks; 1.2 x 1.2 mm pins; Droit; Pas 5 mm; 11 pôles	www.wago.com/231-171/003-000
	N° art.: 231-172/003-000 Male connector for rail-mount terminal blocks; 1.2 x 1.2 mm pins; Droit; Pas 5 mm; 12 pôles	www.wago.com/231-172/003-000
	N° art.: 231-176/003-000 Male connector for rail-mount terminal blocks; 1.2 x 1.2 mm pins; Droit; Pas 5 mm; 16 pôles	www.wago.com/231-176/003-000
	N° art.: 231-180/003-000 Male connector for rail-mount terminal blocks; 1.2 x 1.2 mm pins; Droit; Pas 5 mm; 20 pôles	www.wago.com/231-180/003-000
	N° art.: 231-668 Tiges de fermeture; pour la fermeture de points de connexion non utilisés	www.wago.com/231-668
	N° art.: 231-669 Tiges de fermeture; pour la fermeture de points de connexion non utilisés	www.wago.com/231-669
	N° art.: 721-162/003-000 Male connector for rail-mount terminal blocks; 1.2 x 1.2 mm pins; Droit; 100% protégé contre l'inversion; Pas 5 mm; 2 pôles	www.wago.com/721-162/003-000
	N° art.: 721-163/003-000 Male connector for rail-mount terminal blocks; 1.2 x 1.2 mm pins; Droit; 100% protégé contre l'inversion; Pas 5 mm; 3 pôles	www.wago.com/721-163/003-000
	N° art.: 721-164/003-000 Male connector for rail-mount terminal blocks; 1.2 x 1.2 mm pins; Droit; 100% protégé contre l'inversion; Pas 5 mm; 4 pôles	www.wago.com/721-164/003-000
	N° art.: 721-165/003-000 Male connector for rail-mount terminal blocks; 1.2 x 1.2 mm pins; Droit; 100% protégé contre l'inversion; Pas 5 mm; 5 pôles	www.wago.com/721-165/003-000
	N° art.: 721-166/003-000 Male connector for rail-mount terminal blocks; 1.2 x 1.2 mm pins; Droit; 100% protégé contre l'inversion; Pas 5 mm; 6 pôles	www.wago.com/721-166/003-000

	N° art.: 721-167/003-000 Male connector for rail-mount terminal blocks; 1.2 x 1.2 mm pins; Droit; 100% protégé contre l'inversion; Pas 5 mm; 7 pôles	www.wago.com/721-167/003-000
	N° art.: 721-168/003-000 Male connector for rail-mount terminal blocks; 1.2 x 1.2 mm pins; Droit; 100% protégé contre l'inversion; Pas 5 mm; 8 pôles	www.wago.com/721-168/003-000
	N° art.: 721-169/003-000 Male connector for rail-mount terminal blocks; 1.2 x 1.2 mm pins; Droit; 100% protégé contre l'inversion; Pas 5 mm; 9 pôles	www.wago.com/721-169/003-000
	N° art.: 721-170/003-000 Male connector for rail-mount terminal blocks; 1.2 x 1.2 mm pins; Droit; 100% protégé contre l'inversion; Pas 5 mm; 10 pôles	www.wago.com/721-170/003-000
	N° art.: 721-171/003-000 Male connector for rail-mount terminal blocks; 1.2 x 1.2 mm pins; Droit; 100% protégé contre l'inversion; Pas 5 mm; 11 pôles	www.wago.com/721-171/003-000
	N° art.: 721-172/003-000 Male connector for rail-mount terminal blocks; 1.2 x 1.2 mm pins; Droit; 100% protégé contre l'inversion; Pas 5 mm; 12 pôles	www.wago.com/721-172/003-000
	N° art.: 721-173/003-000 Male connector for rail-mount terminal blocks; 1.2 x 1.2 mm pins; Droit; 100% protégé contre l'inversion; Pas 5 mm; 13 pôles	www.wago.com/721-173/003-000
	N° art.: 721-174/003-000 Male connector for rail-mount terminal blocks; 1.2 x 1.2 mm pins; Droit; 100% protégé contre l'inversion; Pas 5 mm; 14 pôles	www.wago.com/721-174/003-000
	N° art.: 721-175/003-000 Male connector for rail-mount terminal blocks; 1.2 x 1.2 mm pins; Droit; 100% protégé contre l'inversion; Pas 5 mm; 15 pôles	www.wago.com/721-175/003-000
	N° art.: 721-176/003-000 Male connector for rail-mount terminal blocks; 1.2 x 1.2 mm pins; Droit; 100% protégé contre l'inversion; Pas 5 mm; 16 pôles	www.wago.com/721-176/003-000
	N° art.: 721-180/003-000 Male connector for rail-mount terminal blocks; 1.2 x 1.2 mm pins; Droit; 100% protégé contre l'inversion; Pas 5 mm; 20 pôles	www.wago.com/721-180/003-000

Female plug

	N° art.: 232-132/005-000 Female connector for rail-mount terminal blocks; Droit; Pas 5 mm; 2 pôles	www.wago.com/232-132/005-000
	N° art.: 232-132/005-000/039-000 Female connector for rail-mount terminal blocks; Droit; Cliquets de verrouillage; Pas 5 mm; 3 pôles	www.wago.com/232-132/005-000/039-000
	N° art.: 232-133/005-000 Female connector for rail-mount terminal blocks; Droit; Pas 5 mm; 3 pôles	www.wago.com/232-133/005-000

**N° art.: 232-133/005-000/039-000**

Female connector for rail-mount terminal blocks; Droit; Cliquets de verrouillage; Pas 5 mm; 3 pôles

www.wago.com/232-133/005-000/039-000**N° art.: 232-134/005-000**

Female connector for rail-mount terminal blocks; Droit; Pas 5 mm; 4 pôles

www.wago.com/232-134/005-000**N° art.: 232-134/005-000/039-000**

Female connector for rail-mount terminal blocks; Droit; Cliquets de verrouillage; Pas 5 mm; 4 pôles

www.wago.com/232-134/005-000/039-000**N° art.: 232-135/005-000**

Female connector for rail-mount terminal blocks; Droit; Pas 5 mm; 5 pôles

www.wago.com/232-135/005-000**N° art.: 232-135/005-000/039-000**

Female connector for rail-mount terminal blocks; Droit; Cliquets de verrouillage; Pas 5 mm; 5 pôles

www.wago.com/232-135/005-000/039-000**N° art.: 232-136/005-000**

Female connector for rail-mount terminal blocks; Droit; Pas 5 mm; 6 pôles

www.wago.com/232-136/005-000**N° art.: 232-136/005-000/039-000**

Female connector for rail-mount terminal blocks; Droit; Cliquets de verrouillage; Pas 5 mm; 6 pôles

www.wago.com/232-136/005-000/039-000**N° art.: 232-137/005-000**

Female connector for rail-mount terminal blocks; Droit; Pas 5 mm; 7 pôles

www.wago.com/232-137/005-000**N° art.: 232-137/005-000/039-000**

Female connector for rail-mount terminal blocks; Droit; Cliquets de verrouillage; Pas 5 mm; 7 pôles

www.wago.com/232-137/005-000/039-000**N° art.: 232-138/005-000**

Female connector for rail-mount terminal blocks; Droit; Pas 5 mm; 8 pôles

www.wago.com/232-138/005-000**N° art.: 232-138/005-000/039-000**

Female connector for rail-mount terminal blocks; Droit; Cliquets de verrouillage; Pas 5 mm; 8 pôles

www.wago.com/232-138/005-000/039-000**N° art.: 232-139/005-000**

Female connector for rail-mount terminal blocks; Droit; Pas 5 mm; 9 pôles

www.wago.com/232-139/005-000**N° art.: 232-139/005-000/039-000**

Female connector for rail-mount terminal blocks; Droit; Cliquets de verrouillage; Pas 5 mm; 9 pôles















www.wago.com/232-139/005-000/039-000**N° art.: 232-140/005-000**















Female connector for rail-mount terminal blocks; Droit; Pas 5 mm; 10 pôles

www.wago.com/232-140/005-000**N° art.: 232-140/005-000/039-000**

Female connector for rail-mount terminal blocks; Droit; Cliquets de verrouillage; Pas 5 mm; 10 pôles

www.wago.com/232-140/005-000/039-000

	N° art.: 232-142/005-000 Female connector for rail-mount terminal blocks; Droit; Pas 5 mm; 12 pôles	www.wago.com/232-142/005-000
	N° art.: 232-142/005-000/039-000 Female connector for rail-mount terminal blocks; Droit; Cliquets de verrouillage; Pas 5 mm; 12 pôles	www.wago.com/232-142/005-000/039-000
	N° art.: 232-146/005-000 Female connector for rail-mount terminal blocks; Droit; Pas 5 mm; 16 pôles	www.wago.com/232-146/005-000
	N° art.: 232-146/005-000/039-000 Female connector for rail-mount terminal blocks; Droit; Cliquets de verrouillage; Pas 5 mm; 16 pôles	www.wago.com/232-146/005-000/039-000
	N° art.: 232-147/005-000/039-000 Female connector for rail-mount terminal blocks; Droit; Cliquets de verrouillage; Pas 5 mm; 17 pôles	www.wago.com/232-147/005-000/039-000
	N° art.: 232-150/005-000 Female connector for rail-mount terminal blocks; Droit; Pas 5 mm; 20 pôles	www.wago.com/232-150/005-000
	N° art.: 232-150/005-000/039-000 Female connector for rail-mount terminal blocks; Droit; Cliquets de verrouillage; Pas 5 mm; 20 pôles	www.wago.com/232-150/005-000/039-000
	N° art.: 232-232/005-000 Female connector for rail-mount terminal blocks; Coudé; Pas 5 mm; 2 pôles	www.wago.com/232-232/005-000
	N° art.: 232-232/005-000/039-000 Female connector for rail-mount terminal blocks; Coudé; Cliquets de verrouillage; Pas 5 mm; 2 pôles	www.wago.com/232-232/005-000/039-000
	N° art.: 232-233/005-000 Female connector for rail-mount terminal blocks; Coudé; Pas 5 mm; 3 pôles	www.wago.com/232-233/005-000
	N° art.: 232-233/005-000/039-000 Female connector for rail-mount terminal blocks; Coudé; Cliquets de verrouillage; Pas 5 mm; 3 pôles	www.wago.com/232-233/005-000/039-000
	N° art.: 232-234/005-000 Female connector for rail-mount terminal blocks; Coudé; Pas 5 mm; 4 pôles	www.wago.com/232-234/005-000
	N° art.: 232-234/005-000/039-000 Female connector for rail-mount terminal blocks; Coudé; Cliquets de verrouillage; Pas 5 mm; 4 pôles	www.wago.com/232-234/005-000/039-000
	N° art.: 232-235/005-000 Female connector for rail-mount terminal blocks; Coudé; Pas 5 mm; 5 pôles	www.wago.com/232-235/005-000

	N° art.: 232-235/005-000/039-000 Female connector for rail-mount terminal blocks; Coudé; Cliquets de verrouillage; Pas 5 mm; 5 pôles	www.wago.com/232-235/005-000/039-000
	N° art.: 232-236/005-000 Female connector for rail-mount terminal blocks; Coudé; Pas 5 mm; 6 pôles	www.wago.com/232-236/005-000
	N° art.: 232-236/005-000/039-000 Female connector for rail-mount terminal blocks; Coudé; Cliquets de verrouillage; Pas 5 mm; 6 pôles	www.wago.com/232-236/005-000/039-000
	N° art.: 232-237/005-000 Female connector for rail-mount terminal blocks; Coudé; Pas 5 mm; 7 pôles	www.wago.com/232-237/005-000
	N° art.: 232-238/005-000 Female connector for rail-mount terminal blocks; Coudé; Pas 5 mm; 8 pôles	www.wago.com/232-238/005-000
	N° art.: 232-239/005-000 Female connector for rail-mount terminal blocks; Coudé; Pas 5 mm; 9 pôles	www.wago.com/232-239/005-000
	N° art.: 232-240/005-000 Female connector for rail-mount terminal blocks; Coudé; Pas 5 mm; 10 pôles	www.wago.com/232-240/005-000
	N° art.: 232-240/005-000/039-000 Female connector for rail-mount terminal blocks; Coudé; Cliquets de verrouillage; Pas 5 mm; 10 pôles	www.wago.com/232-240/005-000/039-000
	N° art.: 232-242/005-000 Female connector for rail-mount terminal blocks; Coudé; Pas 5 mm; 12 pôles	www.wago.com/232-242/005-000
	N° art.: 232-242/005-000/039-000 Female connector for rail-mount terminal blocks; Coudé; Cliquets de verrouillage; Pas 5 mm; 12 pôles	www.wago.com/232-242/005-000/039-000
	N° art.: 232-246/005-000 Female connector for rail-mount terminal blocks; Coudé; Pas 5 mm; 16 pôles	www.wago.com/232-246/005-000
	N° art.: 232-246/005-000/039-000 Female connector for rail-mount terminal blocks; Coudé; Cliquets de verrouillage; Pas 5 mm; 16 pôles	www.wago.com/232-246/005-000/039-000
	N° art.: 232-250/005-000 Female connector for rail-mount terminal blocks; Coudé; Pas 5 mm; 20 pôles	www.wago.com/232-250/005-000
	N° art.: 232-250/005-000/039-000 Female connector for rail-mount terminal blocks; Coudé; Cliquets de verrouillage; Pas 5 mm; 20 pôles	www.wago.com/232-250/005-000/039-000
	N° art.: 232-732/005-000 Female connector for rail-mount terminal blocks; Droit; Pas 7,5 mm; 2 pôles	www.wago.com/232-732/005-000



N° art.: 232-733/005-000

Female connector for rail-mount terminal blocks; Droit; Pas 7,5 mm; 3 pôles

www.wago.com/232-733/005-000

N° art.: 232-734/005-000

Female connector for rail-mount terminal blocks; Droit; Pas 7,5 mm; 4 pôles

www.wago.com/232-734/005-000

N° art.: 232-734/005-000/039-000

Female connector for rail-mount terminal blocks; Droit; Pas 7,5 mm; 4 pôles

www.wago.com/232-734/005-000/039-000

N° art.: 232-735/005-000

Female connector for rail-mount terminal blocks; Droit; Pas 7,5 mm; 5 pôles

www.wago.com/232-735/005-000

N° art.: 232-735/005-000/039-000

Female connector for rail-mount terminal blocks; Droit; Pas 7,5 mm; 5 pôles

www.wago.com/232-735/005-000/039-000

N° art.: 232-736/005-000

Female connector for rail-mount terminal blocks; Droit; Pas 7,5 mm; 6 pôles

www.wago.com/232-736/005-000

N° art.: 232-736/005-000/039-000

Female connector for rail-mount terminal blocks; Droit; Pas 7,5 mm; 6 pôles

www.wago.com/232-736/005-000/039-000

N° art.: 232-738/005-000

Female connector for rail-mount terminal blocks; Droit; Pas 7,5 mm; 8 pôles

www.wago.com/232-738/005-000

N° art.: 232-740/005-000

Female connector for rail-mount terminal blocks; Droit; Pas 7,5 mm; 10 pôles

www.wago.com/232-740/005-000

N° art.: 232-742/005-000

Female connector for rail-mount terminal blocks; Droit; Pas 7,5 mm; 12 pôles

www.wago.com/232-742/005-000

N° art.: 232-832/005-000

Female connector for rail-mount terminal blocks; Coudé; Pas 7,5 mm; 2 pôles

www.wago.com/232-832/005-000

N° art.: 232-833/005-000

Female connector for rail-mount terminal blocks; Coudé; Pas 7,5 mm; 3 pôles

www.wago.com/232-833/005-000

N° art.: 232-834/005-000















Female connector for rail-mount terminal blocks; Coudé; Pas 7,5 mm; 4 pôles

www.wago.com/232-834/005-000

N° art.: 232-836/005-000















Female connector for rail-mount terminal blocks; Coudé; Pas 7,5 mm; 6 pôles















www.wago.com/232-836/005-000

	N° art.: 232-836/005-000/039-000 Female connector for rail-mount terminal blocks; Coudé; Pas 7,5 mm; 6 pôles	www.wago.com/232-836/005-000/039-000
	N° art.: 232-840/005-000 Female connector for rail-mount terminal blocks; Coudé; Pas 7,5 mm; 10 pôles	www.wago.com/232-840/005-000
	N° art.: 232-842/005-000 Female connector for rail-mount terminal blocks; Coudé; Pas 7,5 mm; 12 pôles	www.wago.com/232-842/005-000
	N° art.: 722-132/005-000 Female connector for rail-mount terminal blocks; Droit; 100% protégé contre l'inversion; Pas 5 mm; 2 pôles	www.wago.com/722-132/005-000
	N° art.: 722-132/005-000/039-000 Female connector for rail-mount terminal blocks; Droit; 100% protégé contre l'inversion; Cliquets de verrouillage; Pas 5 mm; 3 pôles	www.wago.com/722-132/005-000/039-000
	N° art.: 722-133/005-000 Female connector for rail-mount terminal blocks; Droit; 100% protégé contre l'inversion; Pas 5 mm; 3 pôles	www.wago.com/722-133/005-000
	N° art.: 722-133/005-000/039-000 Female connector for rail-mount terminal blocks; Droit; 100% protégé contre l'inversion; Cliquets de verrouillage; Pas 5 mm; 3 pôles	www.wago.com/722-133/005-000/039-000
	N° art.: 722-134/005-000 Female connector for rail-mount terminal blocks; Droit; 100% protégé contre l'inversion; Pas 5 mm; 4 pôles	www.wago.com/722-134/005-000
	N° art.: 722-134/005-000/039-000 Female connector for rail-mount terminal blocks; Droit; 100% protégé contre l'inversion; Cliquets de verrouillage; Pas 5 mm; 4 pôles	www.wago.com/722-134/005-000/039-000
	N° art.: 722-135/005-000 Female connector for rail-mount terminal blocks; Droit; 100% protégé contre l'inversion; Pas 5 mm; 5 pôles	www.wago.com/722-135/005-000
	N° art.: 722-135/005-000/039-000 Female connector for rail-mount terminal blocks; Droit; 100% protégé contre l'inversion; Cliquets de verrouillage; Pas 5 mm; 5 pôles	www.wago.com/722-135/005-000/039-000
	N° art.: 722-136/005-000 Female connector for rail-mount terminal blocks; Droit; 100% protégé contre l'inversion; Pas 5 mm; 6 pôles	www.wago.com/722-136/005-000
	N° art.: 722-136/005-000/039-000 Female connector for rail-mount terminal blocks; Droit; 100% protégé contre l'inversion; Cliquets de verrouillage; Pas 5 mm; 6 pôles	www.wago.com/722-136/005-000/039-000
	N° art.: 722-137/005-000 Female connector for rail-mount terminal blocks; Droit; 100% protégé contre l'inversion; Pas 5 mm; 7 pôles	www.wago.com/722-137/005-000
	N° art.: 722-137/005-000/039-000 Female connector for rail-mount terminal blocks; Droit; 100% protégé contre l'inversion; Cliquets de verrouillage; Pas 5 mm; 7 pôles	www.wago.com/722-137/005-000/039-000

verrouillage; Pas 5 mm; 7 pôles

**N° art.: 722-138/005-000**Female connector for rail-mount terminal blocks; Droit; 100% protégé contre l'inversion; Pas 5 mm; 8 pôles www.wago.com/722-138/005-000**N° art.: 722-138/005-000/039-000**Female connector for rail-mount terminal blocks; Droit; 100% protégé contre l'inversion; Cliquets de verrouillage; Pas 5 mm; 8 pôles www.wago.com/722-138/005-000/039-000**N° art.: 722-139/005-000**Female connector for rail-mount terminal blocks; Droit; 100% protégé contre l'inversion; Pas 5 mm; 9 pôles www.wago.com/722-139/005-000**N° art.: 722-139/005-000/039-000**Female connector for rail-mount terminal blocks; Droit; 100% protégé contre l'inversion; Cliquets de verrouillage; Pas 5 mm; 9 pôles www.wago.com/722-139/005-000/039-000**N° art.: 722-140/005-000**Female connector for rail-mount terminal blocks; Droit; 100% protégé contre l'inversion; Pas 5 mm; 10 pôles www.wago.com/722-140/005-000**N° art.: 722-140/005-000/039-000**Female connector for rail-mount terminal blocks; Droit; 100% protégé contre l'inversion; Cliquets de verrouillage; Pas 5 mm; 10 pôles www.wago.com/722-140/005-000/039-000**N° art.: 722-141/005-000**Female connector for rail-mount terminal blocks; Droit; 100% protégé contre l'inversion; Pas 5 mm; 11 pôles www.wago.com/722-141/005-000**N° art.: 722-142/005-000**Female connector for rail-mount terminal blocks; Droit; 100% protégé contre l'inversion; Pas 5 mm; 12 pôles www.wago.com/722-142/005-000**N° art.: 722-142/005-007/039-000**Female connector for rail-mount terminal blocks; Droit; 100% protégé contre l'inversion; Cliquets de verrouillage; Pas 5 mm; 12 pôles www.wago.com/722-142/005-007/039-000**N° art.: 722-143/005-000**Female connector for rail-mount terminal blocks; Droit; 100% protégé contre l'inversion; Pas 5 mm; 13 pôles www.wago.com/722-143/005-000**N° art.: 722-144/005-000**Female connector for rail-mount terminal blocks; Droit; 100% protégé contre l'inversion; Pas 5 mm; 14 pôles www.wago.com/722-144/005-000**N° art.: 722-144/005-000/039-000**Female connector for rail-mount terminal blocks; Droit; 100% protégé contre l'inversion; Cliquets de verrouillage; Pas 5 mm; 14 pôles www.wago.com/722-144/005-000/039-000**N° art.: 722-145/005-000**Female connector for rail-mount terminal blocks; Droit; 100% protégé contre l'inversion; Pas 5 mm; 15 pôles www.wago.com/722-145/005-000**N° art.: 722-146/005-000**Female connector for rail-mount terminal blocks; Droit; 100% protégé contre l'inversion; Pas 5 mm; 16 pôles www.wago.com/722-146/005-000**N° art.: 722-146/005-000/039-000**

	Female connector for rail-mount terminal blocks; Droit; 100% protégé contre l'inversion; Cliquets de verrouillage; Pas 5 mm; 16 pôles	www.wago.com/722-146/005-000/039-000
	N° art.: 722-150/005-000 Female connector for rail-mount terminal blocks; Droit; 100% protégé contre l'inversion; Pas 5 mm; 20 pôles	www.wago.com/722-150/005-000
	N° art.: 722-150/005-000/039-000 Female connector for rail-mount terminal blocks; Droit; 100% protégé contre l'inversion; Cliquets de verrouillage; Pas 5 mm; 20 pôles	www.wago.com/722-150/005-000/039-000
	N° art.: 722-232/005-000 Female connector for rail-mount terminal blocks; Coudé; 100% protégé contre l'inversion; Pas 5 mm; 3 pôles	www.wago.com/722-232/005-000
	N° art.: 722-232/005-000/039-000 Female connector for rail-mount terminal blocks; Coudé; 100% protégé contre l'inversion; Cliquets de verrouillage; Pas 5 mm; 3 pôles	www.wago.com/722-232/005-000/039-000
	N° art.: 722-233/005-000 Female connector for rail-mount terminal blocks; Coudé; 100% protégé contre l'inversion; Pas 5 mm; 3 pôles	www.wago.com/722-233/005-000
	N° art.: 722-233/005-000/039-000 Female connector for rail-mount terminal blocks; Coudé; 100% protégé contre l'inversion; Cliquets de verrouillage; Pas 5 mm; 3 pôles	www.wago.com/722-233/005-000/039-000
	N° art.: 722-234/005-000 Female connector for rail-mount terminal blocks; Coudé; 100% protégé contre l'inversion; Pas 5 mm; 4 pôles	www.wago.com/722-234/005-000
	N° art.: 722-234/005-000/039-000 Female connector for rail-mount terminal blocks; Coudé; 100% protégé contre l'inversion; Cliquets de verrouillage; Pas 5 mm; 4 pôles	www.wago.com/722-234/005-000/039-000
	N° art.: 722-235/005-000 Female connector for rail-mount terminal blocks; Coudé; 100% protégé contre l'inversion; Pas 5 mm; 5 pôles	www.wago.com/722-235/005-000
	N° art.: 722-235/005-000/039-000 Female connector for rail-mount terminal blocks; Coudé; 100% protégé contre l'inversion; Cliquets de verrouillage; Pas 5 mm; 5 pôles	www.wago.com/722-235/005-000/039-000
	N° art.: 722-236/005-000 Female connector for rail-mount terminal blocks; Coudé; 100% protégé contre l'inversion; Pas 5 mm; 6 pôles	www.wago.com/722-236/005-000
	N° art.: 722-236/005-000/039-000 Female connector for rail-mount terminal blocks; Coudé; 100% protégé contre l'inversion; Cliquets de verrouillage; Pas 5 mm; 6 pôles	www.wago.com/722-236/005-000/039-000
	N° art.: 722-237/005-000 Female connector for rail-mount terminal blocks; Coudé; 100% protégé contre l'inversion; Pas 5 mm; 7 pôles	www.wago.com/722-237/005-000
	N° art.: 722-237/005-000/039-000 Female connector for rail-mount terminal blocks; Coudé; 100% protégé contre l'inversion; Cliquets de verrouillage; Pas 5 mm; 7 pôles	www.wago.com/722-237/005-000/039-000

	N° art.: 722-238/005-000 Female connector for rail-mount terminal blocks; Coudé; 100% protégé contre l'inversion; Pas 5 mm; 8 pôles	www.wago.com/722-238/005-000
	N° art.: 722-239/005-000 Female connector for rail-mount terminal blocks; Coudé; 100% protégé contre l'inversion; Pas 5 mm; 9 pôles	www.wago.com/722-239/005-000
	N° art.: 722-239/005-000/039-000 Female connector for rail-mount terminal blocks; Coudé; 100% protégé contre l'inversion; Cliquets de verrouillage; Pas 5 mm; 9 pôles	www.wago.com/722-239/005-000/039-000
	N° art.: 722-240/005-000 Female connector for rail-mount terminal blocks; Coudé; 100% protégé contre l'inversion; Pas 5 mm; 10 pôles	www.wago.com/722-240/005-000
	N° art.: 722-240/005-000/039-000 Female connector for rail-mount terminal blocks; Coudé; 100% protégé contre l'inversion; Cliquets de verrouillage; Pas 5 mm; 10 pôles	www.wago.com/722-240/005-000/039-000
	N° art.: 722-241/005-000 Female connector for rail-mount terminal blocks; Coudé; 100% protégé contre l'inversion; Pas 5 mm; 11 pôles	www.wago.com/722-241/005-000
	N° art.: 722-242/005-000 Female connector for rail-mount terminal blocks; Coudé; 100% protégé contre l'inversion; Pas 5 mm; 12 pôles	www.wago.com/722-242/005-000
	N° art.: 722-242/005-000/039-000 Female connector for rail-mount terminal blocks; Coudé; 100% protégé contre l'inversion; Cliquets de verrouillage; Pas 5 mm; 12 pôles	www.wago.com/722-242/005-000/039-000
	N° art.: 722-243/005-000 Female connector for rail-mount terminal blocks; Coudé; 100% protégé contre l'inversion; Pas 5 mm; 13 pôles	www.wago.com/722-243/005-000
	N° art.: 722-244/005-000 Female connector for rail-mount terminal blocks; Coudé; 100% protégé contre l'inversion; Pas 5 mm; 14 pôles	www.wago.com/722-244/005-000
	N° art.: 722-244/005-000/039-000 Female connector for rail-mount terminal blocks; Coudé; 100% protégé contre l'inversion; Cliquets de verrouillage; Pas 5 mm; 14 pôles	www.wago.com/722-244/005-000/039-000
	N° art.: 722-246/005-000 Female connector for rail-mount terminal blocks; Coudé; 100% protégé contre l'inversion; Pas 5 mm; 16 pôles	www.wago.com/722-246/005-000
	N° art.: 722-246/005-000/039-000 Female connector for rail-mount terminal blocks; Coudé; 100% protégé contre l'inversion; Cliquets de verrouillage; Pas 5 mm; 16 pôles	www.wago.com/722-246/005-000/039-000
	N° art.: 722-250/005-000 Female connector for rail-mount terminal blocks; Coudé; 100% protégé contre l'inversion; Pas 5 mm; 20 pôles	www.wago.com/722-250/005-000



Téléchargements

Documentation

Bid Text

280-558	Oct 12, 2017	DOC 25,6 kB	Téléchargement
---------	--------------	----------------	----------------

smartDATA

CAD data

3D Download 280-558	URL	Téléchargement
---------------------	-----	----------------

Sous réserve de modifications.