

Mounting Blocks · for index bolts and index plungers

22120.0546

Product Description

Assembly support and extended applications for index bolts.
Also usable for index plungers size 6, 8 and 10.

Material

Grub Screw

- Stainless steel, with brass pad

Body

- Stainless steel 1.4305



Drawing

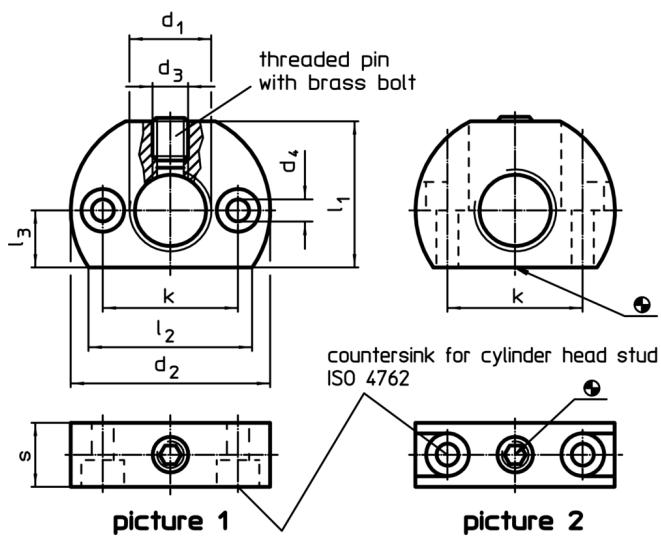

Order information

Dimensions									max. [°C]	[g]	Art. No.
d ₁	d ₂	d ₃	d ₄	k ±0.1	l ₁	l ₂ ~	l ₃	s			
mounting hole parallel to index bolt and index plunger – picture 1, stainless steel											
M16 x 1,5	46	M8	5.5	32	33	38	13	15	250	121	22120.0546

Application example

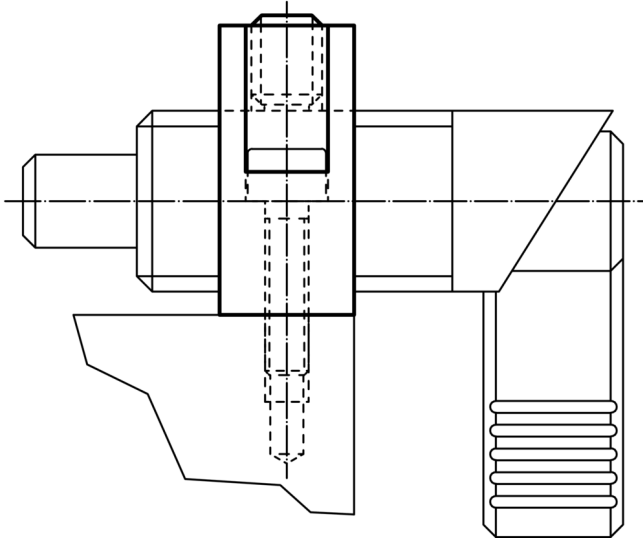

Compliance

RoHS compliant

Compliant according to Directive 2011/65/EU and Directive 2015/863

Does not contain SVHC substances

No SVHC substances with more than 0.1% w/w contained - SVHC list [REACH] as of 10.06.2022

Does not contain Proposition 65 substances

No Proposition 65 substances included
<https://www.P65Warnings.ca.gov/>

Free from Conflict Minerals

This product does not contain any substances designated as "conflict minerals" such as tantalum, tin, gold or tungsten from the Democratic Republic of Congo or adjacent countries.