

# Finger guards



- **Material:** Galvanized or nickel-plated steel wire
- **Note:** Finger guard according to DIN EN ISO 13857 (previously EN 294). Additional finger guards that do not satisfy DIN EN ISO 13857 available on request.  
Our finger guards are designed specifically to be used with ebm-papst fans. They combine the highest degree of safety with minimum effect on the operating noise. Please note that the safety-related clearances cannot be guaranteed when finger guards made by other manufacturers are used.

Fan size	Fan series	Type	Order number	Side	Drawing see page
40 x 40	400 F, 400, 420 J	<b>LZ29-1</b>	9920029001	Intake/Outlet	255
50 x 50	500 F	<b>LZ31</b>	9920031000	Intake/Outlet	255
60 x 60	600 F, 620, 630, 600 N, 600 J	<b>LZ28</b>	9920028000	Intake/Outlet	255
		<b>LZ28-1</b>	9920028001		
80 x 80	8450, 8400 N, 8300 N, 8200 J, 8000 N, CoR 8200 J	<b>LZ22-2</b>	9920022002	Intake/Outlet	255
		<b>LZ32-4</b>	9920032004		
		<b>LZ22-N</b>	9920022001		
		<b>LZ32-14</b>	9920145006		
92 x 92	3400 N, 3300 N, 3200 J, 3250 J, 3900, 3000	<b>LZ23</b>	9920023000	Intake/Outlet	255
		<b>LZ23-1</b>	9920023001		
119 x 119	4400 F, 4400 FN, 4300 N, 4400, 4100 N, 4000 N, 4000 Z, 9900	<b>LZ20</b>	9920020000	Intake/Outlet	255
		<b>LZ30</b>	9920030000		256
		<b>LZ30-3</b>	9920030003		
	<b>LZ30-4</b>	9920030004	256		
	DV 4100	<b>LZ30-4</b>	9920030004	Intake/Outlet	256
127 x 127	DV 5200	<b>LZ35</b>	9920035000	Intake/Outlet	256
	5200 N, 5900	<b>LZ35</b>	9920035000	Intake/Outlet	256
		<b>LZ35-2</b>	9920035002		
135 x 135	5100 N, 5600	<b>LZ25</b>	9920025000	Intake/Outlet	256
140 x 140	5300, 5300 TD	<b>LZ53</b>	9920053000	Intake/Outlet	256
Ø 150	7100 N, 7200 N	<b>LZ24</b>	9920024000	Intake/Outlet	256
		<b>LZ27</b>	9920027000	Intake/Outlet	257
		<b>LZ36</b>	9920036000		
Ø 172	6300 N, 6300 NTD, 6300, 6300 TD	<b>LZ26</b>	9920026000	Intake/Outlet	257
		<b>LZ37</b>	9920037000		
		<b>LZ37-10</b>	9920145004		
		<b>LZ38</b>	9920038000		
	DV 6300	<b>LZ39</b>	9920039000	Outlet side	257
<b>LZ52</b>	9920052000	Intake side			
172 x 150	6400, 6400 TD	<b>LZ38</b>	9920038000	Intake/Outlet	257
172 x 160	DV 6400, DV 6400 TD	<b>LZ38</b>	9920038000	Intake side	257
220 x 200	2200 FTD	<b>LZ22</b>	9920022000	Intake/Outlet	257
Fan unit		<b>LZ38-1</b>	9920038001		257

Subject to change

All measurements are given in mm.

# Finger guards

LZ29-1

Fan size 40 x 40

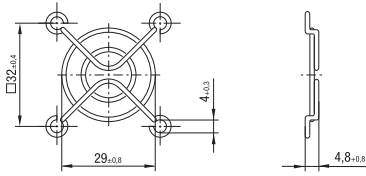

LZ31

Fan size 50 x 50

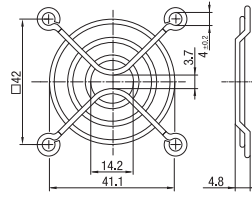

LZ28

Fan size 60 x 60

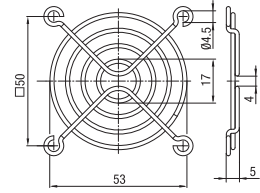

LZ28-1

Fan size 60 x 60

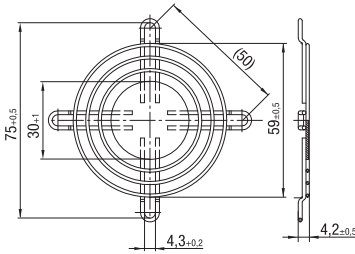

LZ22-2

Fan size 80 x 80

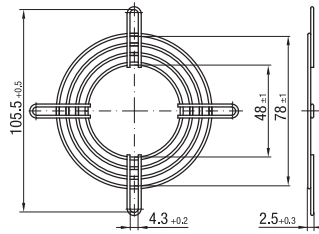

LZ32-4

Fan size 80 x 80

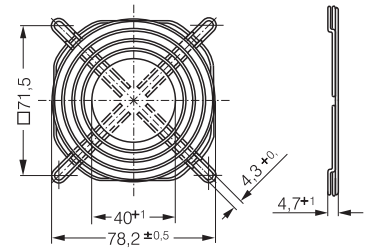

LZ22-N

Fan size 80 x 80

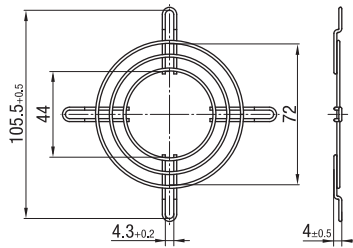

LZ32-14

Fan size 80 x 80

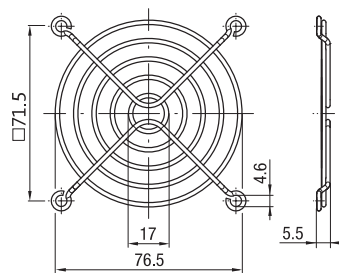

LZ23

Fan size 92 x 92

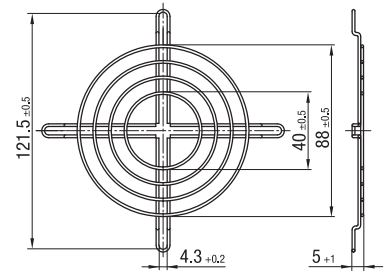

LZ23-1

Fan size 92 x 92

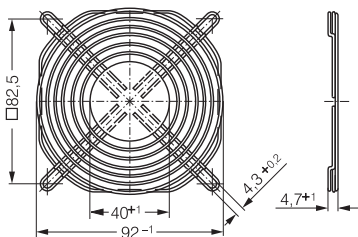

LZ20

Fan size 119 x 119

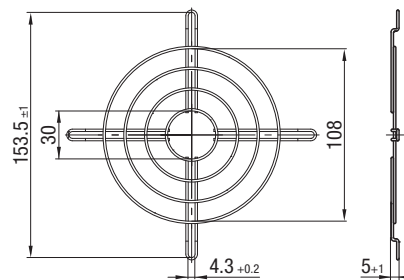

LZ30

Fan size 119 x 119

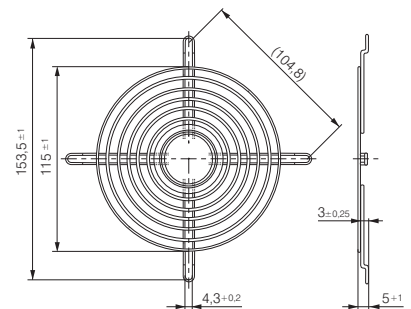

# Finger guards

ACmaxx / ACi

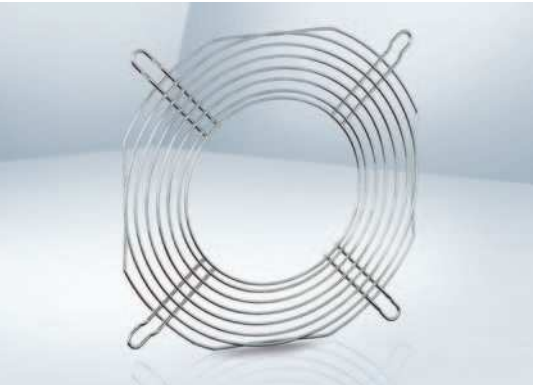

- **Material:** Galvanized or nickel-plated steel wire
- **Note:** Finger guard according to DIN EN ISO 13857 (previously EN 294).  
Finger guards for air outlet described on this page are specifically for fan series ACmaxx.  
For air intake side the standard finger guards with a corresponding dimension can be used.

## Finger guards made of metal

Fan size	Fan series	Type	Order number	Side	Drawing see page
80 x 80	AC 8300 H	<b>LZ32-7</b>	9920032007	Outlet side	259
	AC 8300 H	<b>LZ22-N</b>	9920022001	Intake side	255
		<b>LZ22-2</b>	9920022002		
		<b>LZ32-14</b>	9920145006		
		<b>LZ32-4</b>	9920032004		
92 x 92	AC 3200 J	<b>LZ23-6</b>	9920023006	Outlet side	259
	AC 3200 J	<b>LZ23</b>	9920023000	Intake side	255
		<b>LZ23-1</b>	9920023001		
119 x 119	ACi 4400, ACi 4400 N	<b>LZ20</b>	9920020000	Intake side	255
		<b>LZ30</b>	9920030000		
	AC 4400 FN	<b>LZ30-3</b>	9920030003		256
		<b>LZ30-4</b>	9920030004		
	AC 4400 FN AC 4300	<b>LZ30-9</b>	9920030009	Outlet side	259
Ø 172	AC 6200 N	<b>LZ26</b>	9920026000	Intake side	256
		<b>LZ37</b>	9920037000		
		<b>LZ37-10</b>	9920145004		257
		<b>LZ52</b>	9920052000		
	AC 6200 N	<b>LZ37-2</b>	9920037002	Outlet side	259

Subject to change

All measurements are given in mm.

## Finger guards made of plastic

Fan size	Fan series	Type	Order number	Side	Drawing see page
119 x 119	AC 4400 FN, AC 4300	<b>LZ30-5</b>	9920030005	Intake side	263
	ACi 4400, ACi 4400 N	<b>LZ30-6</b>	9920030006		
119 x 119	ACi 4400, ACi 4400 N	<b>LZ30-P</b>	9920030001	Intake/Outlet	263

Subject to change

All measurements are given in mm.