

High-end Line Filter for Machinery/Equipment



- Now available up to 600 A
- Compact, space-saving design, optimized for industrial machinery
- Combines exceptional attenuation with low leakage current
- Suitable for machines in mixed/domestic environments (Class A/B)
- Increases also the immunity if operated directly on the mains input



Performance indicators

Attenuation performance

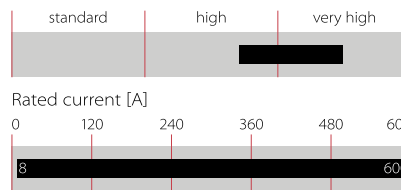

Approvals & Compliances



Features and benefits

A compact and light weight filter design with a „cubic“ shape, requiring minimum mounting space and thus taking the constructional conditions on the mains input of machinery into account

Simple and time-saving installation with good accessibility for automatic and hand tools

Solid, touch-safe terminal blocks (8 to 200 A types) offering sufficient contacting cross section according to the EN 60204-1 installation standard, which is very common in industrial applications

As a mains input filter for three phases and neutral line, FN 3280 provides enough performance to ensure EMC compliance of machinery in mixed (Class A) or even domestic (Class B) environments. Further, its use will also increase the immunity of the entire installation significantly

FN 3280 provides the attenuation performance needed to meet the requirements of various machine tools with up to 12 driving axes and ~10 to 20 m of motor cable each

For easy selection and application, the filter current ratings are aligned with common fuse values

Technical specifications

- Maximum continuous operating voltage**
- Operating frequency**
- Rated currents**
- High potential test voltage**
- Protection category**
- Overload capability**
- Temperature range (operation and storage)**
- Flammability corresponding to**
- Design corresponding to**
- MTBF @ 50°C/400 V (Mil-HB-217F)**

- 3x 520/300 VAC (480 VAC + 10% possible)
- DC to 60 Hz
- 8 to 600 A @ 50°C
- P/N -> E 2750 VDC for 2 sec
- P -> P 2250 VDC for 2 sec
- P -> N 1300 VDC for 2 sec
- IP 20 (8 to 200 A types)
- IP 00 (300 to 600 A types)
- 4x rated current at switch on,
- 1.5x rated current for 1 minute, once per hour
- 25°C to +100°C (25/100/21)
- UL 94 V-2 or better
- UL 1283, CSA 22.2 No. 8 1986, IEC/EN 60939
- >360,000 hours







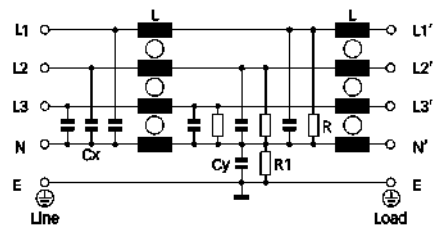





Typical applications

Mainly industrial equipment, machinery, machine tools and diverse process automation systems with three-phase and neutral electricity supply. Due to the outstanding attenuation performance, FN 3280 is also the first choice for noisy power supplies, renewable energy applications, highpower office equipment and further three-phase and neutral devices. Because of the relatively low leakage current, FN 3280 may even be used for some medical devices.

Typical electrical schematic



Filter selection table

Filter	Rated current	Leakage current*	Power loss	Input/Output connections	Weight
	@ 50°C (40°C)	@ 520 VAC/50 Hz	@ 25°C/50 Hz		
	[A]	[mA]	[W]		[kg]
FN 3280 H-8-29	8 (8.8)	10.7	2.7	 -29	0.8
FN 3280 H-16-29	16 (17.5)	10.7	6.0	 -29	0.8
FN 3280 H-25-33	25 (27)	10.7	11.6	 -33	1.3
FN 3280 H-36-33	36 (39)	10.7	14.8	 -33	1.6
FN 3280 H-64-34	64 (70)	10.7	18.4	 -34	2.7
FN 3280 H-80-35	80 (88)	10.7	18.9	 -35	4.1
FN 3280 H-120-35	120 (131)	10.7	28.5	 -35	5.9
FN 3280 H-160-40	160 (175)	10.7	30.7	 -40	7.9
FN 3280 H-200-40	200 (219)	10.7	46.8	 -40	8.5
FN 3280 H-300-99	300 (328)	42.1	20.3	 -99	10.0
FN 3280 H-400-99	400 (438)	42.1	36.0	 -99	10.0
FN 3280 H-600-99	600 (657)	42.1	64.8	 -99	11.0

* Standardized calculated leakage current acc. IEC60939 under normal operating conditions.

Typical filter attenuation

Per CISPR 17; A=50 Ω/50 Ω sym; B=50 Ω/50 Ω asym; C=0.1 Ω/100 Ω sym; D=100 Ω/0.1 Ω sym

8 and 16 A types

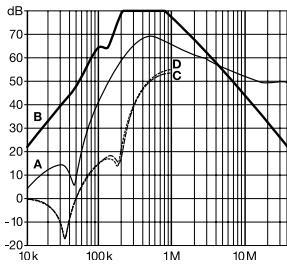

25 and 36 A types

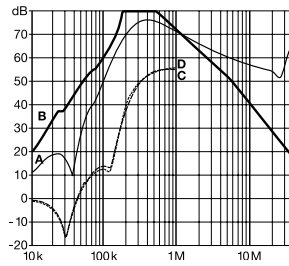

64 to 120 A types

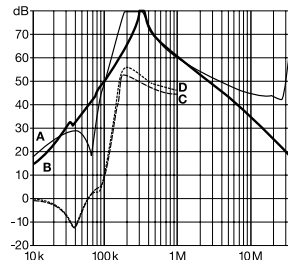

160 and 200 A types

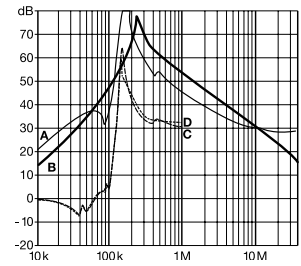

300 to 600 A types

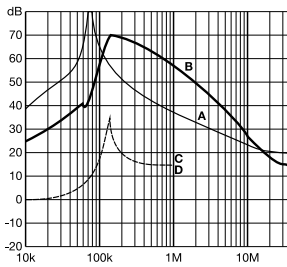

Mechanical data

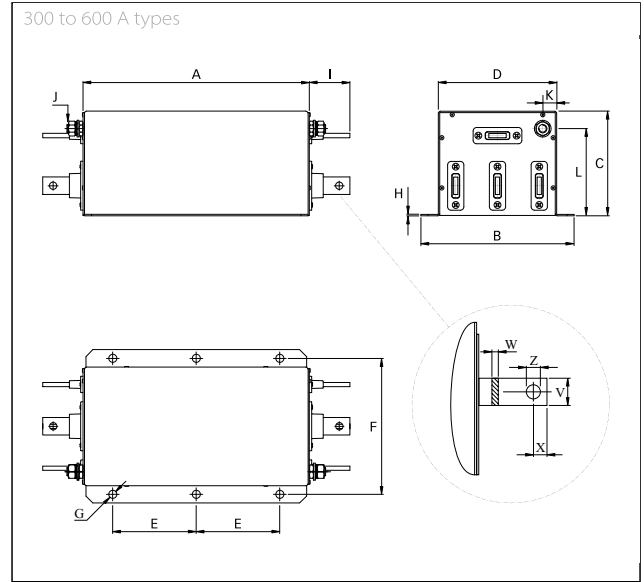
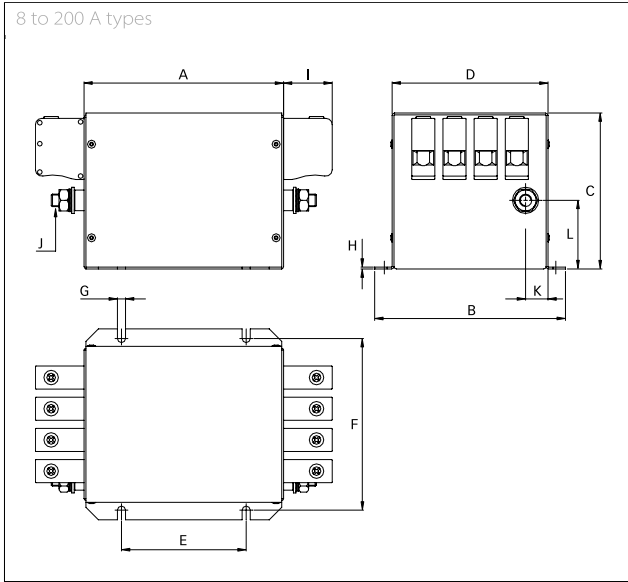

Dimensions

	8 A	16 A	25 A	36 A	64 A	80 A	120 A	160 A	200 A	300 A	400 A	600 A
A	120	120	130	130	160	230	250	280	280	325	325	325
B	143	143	153	153	153	163	170	170	170	220	220	220
C	80	80	115	115	125	125	140	170	170	150	150	150
D	115	115	125	125	125	135	140	140	140	170	170	170
E	80	80	90	90	100	120	200	230	230	120	120	120
F	127.5	127.5	137.5	137.5	137.5	147.5	153.5	153.5	153.5	195	195	195
G	6.5	6.5	6.5	6.5	6.5	6.5	6.5	6.5	6.5	12	12	12
H	1	1	1	1	1.5	1.5	1.5	1.5	1.5	2	2	2
I	10.9	10.9	25	25	39	45	45	51	51	58	58	58
J	M6	M6	M6	M6	M10	M10	M10	M10	M10	M12	M12	M12
K	12	12	12	12	18	18	17.5	17.5	17.5	20	20	20
L	33	33	50	50	55	45	55	55	55	125	125	125
V										25	25	25
W										6	6	8
X										15	15	15
Z										Ø10.5	Ø10.5	Ø10.5

All dimensions in mm; 1 inch = 25.4 mm
Tolerances according: ISO 2768-m/EN 22768-m

Filter input/output connector cross sections

	-29	-33	-34	-35	-40
Solid wire	6 mm ²	16 mm ²	35 mm ²	50 mm ²	95 mm ²
Flex wire	4 mm ²	10 mm ²	25 mm ²	50 mm ²	95 mm ²
AWG type wire	AWG 10	AWG 6	AWG 2	AWG 1/0	AWG 4/0
Recommended torque	0.6-0.8 Nm	1.5-1.8 Nm	4.0-4.5 Nm	7-8 Nm	17-20 Nm

Please visit www.schaffner.com to find more details on filter connectors.



Headquarters, global innovation and development

Switzerland

Schaffner Group

Industrie Nord
Nordstrasse 11e
4542 Luterbach
T +41 32 681 66 26
info@schaffner.com

To find your local partner within Schaffner's global network: www.schaffner.com

© 2018 Schaffner Group

The content of this document has been carefully checked and understood. However, neither Schaffner nor its subsidiaries assume any liability whatsoever for any errors or inaccuracies of this document and the consequences thereof. Published specifications are subject to change without notice. Product suitability for any area of application must ultimately be determined by the customer. In all cases, products must never be operated outside their published specifications. Schaffner does not guarantee the availability of all published products. This disclaimer shall be governed by substantive Swiss law and resulting disputes shall be settled by the courts at the place of business of Schaffner Holding AG. Latest publications and a complete disclaimer can be downloaded from the Schaffner website. All trademarks recognized.

Sales and application centers

China

Schaffner EMC Ltd. Shanghai

T20-3 C, No 565 Chuangye Road,
Pudong district
201201 Shanghai
T +86 21 3813 9500
cschina@schaffner.com
www.schaffner.com.cn

Finland

Schaffner Oy

Sauvonrinne 19 H
08500 Lohja
T +358 10 567 2855
finlandsales@schaffner.com

France

Schaffner EMC S.A.S.

16-20 Rue Louis Rameau
95875 Bezons
T +33 1 34 34 30 60
F +33 1 39 47 02 28
francesales@schaffner.com

Germany

Schaffner Deutschland GmbH

Schoemperlenstrasse 12B
76185 Karlsruhe
T +49 721 56910
F +49 721 569110
germanysales@schaffner.com

India

Schaffner India Pvt. Ltd

REGUS WORLD TRADE CENTRE
WTC, 22nd Floor Unit No 2238, Brigade Gateway
Campus, 26/1, Dr. Rajkumar Road Malleshwaram (W)
560055 Bangalore
T +91 80 67935355
indiasales@schaffner.com

Italy

Schaffner EMC S.r.l.

Via Ticino, 30
20900 Monza (MB)
T +39 039 21 41 070
italysales@schaffner.com

Japan

Schaffner EMC K.K.

Taiju-Seimei Sangenjaya Bldg.
1-32-12, Kamiyama, Setagaya-ku
154-0011 Tokyo
T +81 3 5712 3650
F +81 3 5712 3651
japansales@schaffner.com
www.schaffner.jp

Singapore

Schaffner EMC Pte Ltd.

#05-09, Kg Ubi Ind. Estate
408705 Singapore
T +65 6377 3283
F +65 6377 3281
singaporesales@schaffner.com

Spain

Schaffner EMC España

Calle Caléndula 93, Miniparc III, Edificio E
El Soto de Moraleja, Alcobendas
28109 Madrid
T +34 917 912 900
F +34 917 912 901
spainsales@schaffner.com

Sweden

Schaffner EMC AB

Östermalmstorg 1
114 42 Stockholm
T +46 8 5050 2425
swedensales@schaffner.com
www.schaffner.com

Switzerland

Schaffner EMV AG

Industrie Nord
Nordstrasse 11e
4542 Luterbach
T +41 32 681 66 26
switzerlandsales@schaffner.com

Taiwan R.O.C.

Schaffner EMV Ltd.

20 Floor-2, No 97, Section 1, XinTai 5th Road
22175 XiZhi District New Taipei City 22175
T +886 2 2697 5500
F +886 2 2697 5533
taiwansales@schaffner.com
www.schaffner.com.tw

Thailand

Schaffner EMC Co. Ltd.

Northern Region Industrial Estate
67 Moo 4 Tambon Ban Klang
Amphur Muang P.O. Box 14
51000 Lamphun
T +66 53 58 11 04
F +66 53 58 10 19
thailandsales@schaffner.com

United Kingdom

Schaffner Ltd.

1, Oakmede Place
Binfield
RG42 4JF Berkshire
T +44 118 9770070
F +44 118 9792969
uksales@schaffner.com

USA

Schaffner EMC Inc.

52 Mayfield Avenue
Edison, New Jersey
T +1 732 225 9533
F +1 732 225 4789
usasales@schaffner.com
www.schaffnerusa.com

Schaffner North America

6722 Thirlane Road
24019 Roanoke, Virginia
T +1 276 228 7943
F +1 276 228 7953

Schaffner North America

823 Fairview Road
24382 Wytheville, Virginia
T +1 276 228 7943
F +1 276 228 7258