

647402-5 ✓ ACTIVE

MTA | SL-156

TE Internal #: 647402-5

SL-156, Housing, Receptacle, Wire-to-Board, 5 Position, 3.96mm [.156in] Centerline, Crimp, 1 Row, Natural Housing Color, Mating Retention

[View on TE.com >](#)



Connectors > PCB Connectors > Wire-to-Board Connectors > Wire-to-Board Connector Assemblies & Housings >

3.96mm Wire-to-board housing: receptacle, with mating alignment, SL 156



Connector Product Type: **Housing**

Connector & Housing Type: **Receptacle**

Connector System: **Wire-to-Board**

Number of Positions: **5**

Centerline (Pitch): **3.96 mm [.156 in]**

[All 3.96mm Wire-to-board housing: receptacle, with mating alignment, SL 156 \(124\)](#)

Features

Product Type Features

Connector Product Type	Housing
Connector & Housing Type	Receptacle
Connector System	Wire-to-Board
Sealable	No
Connector & Contact Terminates To	Wire & Cable

Configuration Features

Number of Positions	5
Number of Rows	1

Electrical Characteristics

Operating Voltage	250 VAC
-------------------	---------

Contact Features

--	--



Contact Layout	Inline
Contact Retention Within Housing	Without
Contact Type	Socket
Contact Current Rating (Max)	6.5 A

Termination Features

Termination Method to Wire & Cable	Crimp
------------------------------------	-------

Mechanical Attachment

Strain Relief	Without
PCB Mount Alignment	Without
Panel Mount Feature	Without
PCB Mount Retention	Without
Mating Retention Type	Locking Ramp
Mating Retention	With
Connector Mounting Type	Cable Mount (Free-Hanging)

Housing Features

Housing Entry Configuration	Left End Open
Housing Material	Nylon - GF
Centerline (Pitch)	3.96 mm [.156 in]
Housing Color	Natural

Dimensions

	.658 in
Connector Height	6.35 mm
Wire Size	.0509 – .823 mm ²

Usage Conditions

Operating Temperature Range	-55 – 105 °C [-67 – 221 °F]
-----------------------------	-----------------------------

Operation/Application

Circuit Application	Power & Signal
---------------------	----------------

Industry Standards

CSA Rating	Certified
UL Flammability Rating	UL 94V-0
UL File Number	E28476
UL Rating	Listed



Agency/Standard	CSA, UL
CSA File Number	LR 7189

Packaging Features

Packaging Quantity	1
Packaging Method	Package

Other

Comment	Unit Accepts 1.14[.045] Square or Round Post, Accepts Keying Plug 640254-1 and 640255-1
---------	---

Product Compliance





[For compliance documentation, visit the product page on TE.com>](#)

EU RoHS Directive 2011/65/EU	Compliant
EU ELV Directive 2000/53/EC	Compliant
China RoHS 2 Directive MIIT Order No 32, 2016	No Restricted Materials Above Threshold
EU REACH Regulation (EC) No. 1907/2006	Current ECHA Candidate List: JAN 2021 (211) Candidate List Declared Against: JAN 2021 (211) Does not contain REACH SVHC
Halogen Content	Low Halogen - Br, Cl, F, I < 900 ppm per homogenous material. Also BFR/CFR/PVC Free
Solder Process Capability	Not applicable for solder process capability

Product Compliance Disclaimer

This information is provided based on reasonable inquiry of our suppliers and represents our current actual knowledge based on the information they provided. This information is subject to change. The part numbers that TE has identified as EU RoHS compliant have a maximum concentration of 0.1% by weight in homogenous materials for lead, hexavalent chromium, mercury, PBB, PBDE, DBP, BBP, DEHP, DIBP, and 0.01% for cadmium, or qualify for an exemption to these limits as defined in the Annexes of Directive 2011/65/EU (RoHS2). Finished electrical and electronic equipment products will be CE marked as required by Directive 2011/65/EU. Components may not be CE marked. Additionally, the part numbers that TE has identified as EU ELV compliant have a maximum concentration of 0.1% by weight in homogenous materials for lead, hexavalent chromium, and mercury, and 0.01% for cadmium, or qualify for an exemption to these limits as defined in the Annexes of Directive 2000/53/EC (ELV). Regarding the REACH Regulation, the information TE provides on SVHC in articles for this part number is based on the latest European Chemicals Agency (ECHA) 'Guidance on requirements for substances in articles' posted at this URL: <https://echa.europa.eu/guidance-documents/guidance-on-reach>

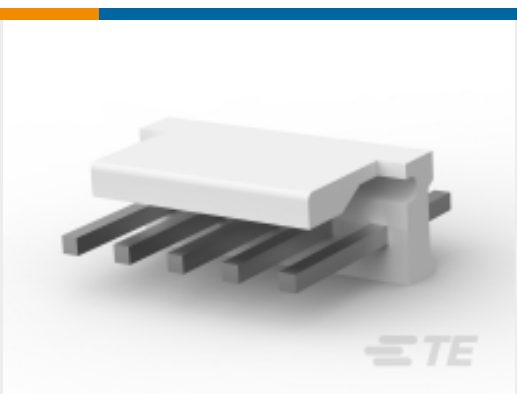
Compatible Parts

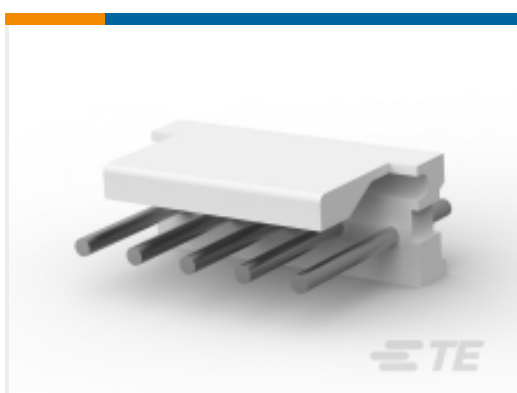
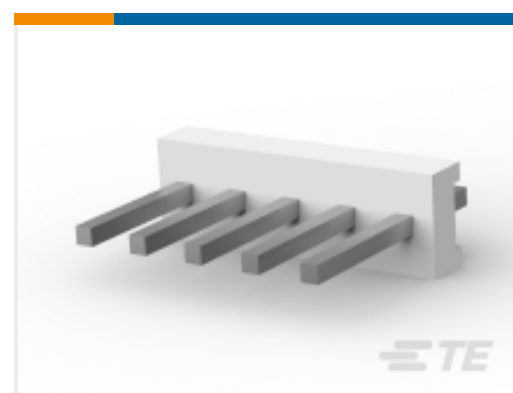
 <p>TE Part # 3-644613-5 05P MTA156 HDR RA PO WO PEG LF</p>	 <p>TE Part # 640551-5 05P MTA156 COVER</p>	 <p>TE Part # 640389-5 05P MTA156 HDR ASSY SQ R/A F/L</p>	 <p>TE Part # 640384-5 05P MTA156 HDR ASSY STR RND SN</p>
 <p>TE Part # 3-641208-5 05P MTA156 HDR ASSY FL ST LF</p>	 <p>TE Part # 3-641210-5 05P MTA156 HDR FLRA FB 30AU LF</p>	 <p>TE Part # 640385-5 05P MTA156 HDR ASSY SQ R/A</p>	 <p>TE Part # 3-641119-5 05P MTA156 HDR ASSY FL/ST LF</p>
 <p>TE Part # 640643-5 05P MTA156 COVER F/T</p>	 <p>TE Part # 643495-2 05P MTA156 HDR ASSY W/O#2&4</p>	 <p>TE Part # 640445-5 05P MTA156 HDR ASSY FL/STR SN</p>	 <p>TE Part # 3-644615-5 05P MTA156 POL HDR ASSY LF</p>
 <p>TE Part # 644752-5 05P MTA156 HDR ASSY SQ STR F/L</p>	 <p>TE Part # 643495-1 05P MTA156 HDR ASSY W/O#4</p>	 <p>TE Part # 643067-5 05P MTA156 MOLDED COVER</p>	 <p>TE Part # 3-644611-5 05P MTA156 HDR POL WO PEGS LF</p>
 <p>TE Part # 3-644759-5 05P MTA156 HDR ASSY STR LF</p>	 <p>TE Part # 640388-5 05P MTA156 HDR ASSY RN STR F/L</p>	 <p>TE Part # 643495-3 05P MTA156 HDR ASSY W/O#2</p>	 <p>TE Part # 640383-5 05P MTA156 HDR ASSY STR SQ SN</p>

Also in the Series | **SL-156**



Insertion & Extraction Tools(1)



PCB Connector Keying(2)

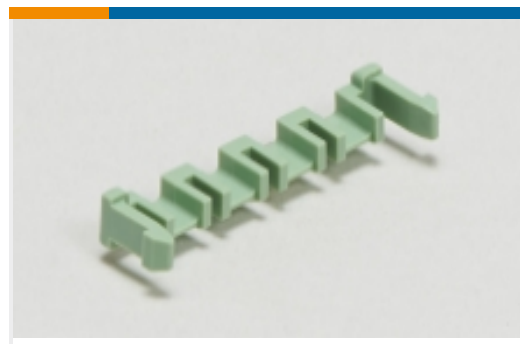

PCB Latches, Locks & Retainers(1)



Rectangular Connector Housings(12)

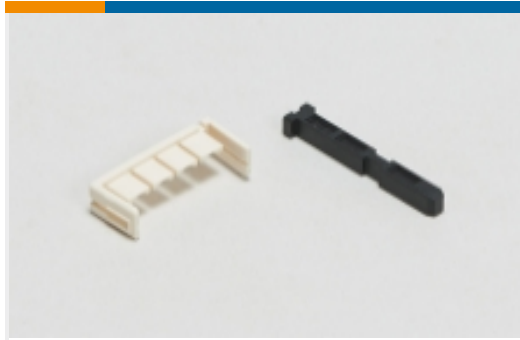

Rectangular Connector Keying Plugs(1)



Wire-to-Board Connector Assemblies & Housings(157)



Wire-to-Board Connector Contacts(24)

Customers Also Bought



TE Part #1-647402-5
3.96mm Wire-to-board housing: receptacle, with mating alignment, SL 156

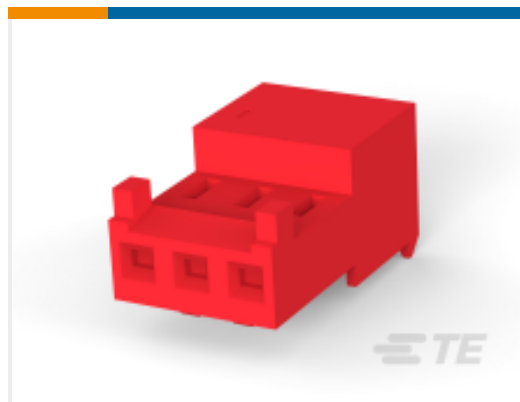

TE Part #3-643814-4
Nylon Tin Plated Receptacle: 2.54mm, With Mating Alignment, MTA 100



TE Part #166995-2
D-Sub Connector Contacts: Pin, Brass, Signal, Size 20



TE Part #213866-1
CPC SERIES 1



TE Part #926302-1
10& UNIV.M-N-L.PLUG

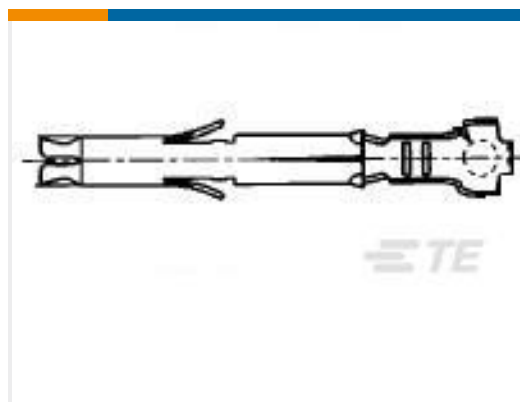

TE Part #170365-3
MINI UNIVERSAL M-N-L SOCKET LP



TE Part #179464-1
POWER DBL LOCK CAP HSG F/H 3P



TE Part #1742800-1
FF 187 TAB 18-14AWG TPBR



TE Part #1721870-5
STD OEG Miniature PCB OJ/OJE Pow Relays

Documents



Product Drawings

[05P SL156 HSG W/RMP&TABS,OVSZ](#)

English

CAD Files

[3D PDF](#)

3D

Customer View Model

[ENG_CVM_CVM_647402-5_C.2d_dxf.zip](#)

English

Customer View Model

[ENG_CVM_CVM_647402-5_C.3d_igs.zip](#)

English

Customer View Model

[ENG_CVM_CVM_647402-5_C.3d_stp.zip](#)

English

By downloading the CAD file I accept and agree to the [Terms and Conditions](#) of use.

Datasheets & Catalog Pages

[MTA, CST-100 II, SL-156 and AMP Economy Power \(EP\) Connectors](#)

English

Product Specifications

[Application Specification](#)

English

Product Environmental Compliance

[TE Material Declaration](#)

English

Agency Approvals

[CSA Certificate](#)

English
