

EQ-500 SERIES

ADJUSTABLE RANGE REFLECTIVE PHOTOELECTRIC SENSOR

Multi-voltage **Amplifier Built-in**



Long sensing range 2.5 m



Multi-voltage

EQ50

Because it can function with 24 to 240 V AC and 12 to 240 V DC, almost any power supply anywhere in the world will do.

New

EQ51

Introducing the new DC-voltage type equipped with BGS / FGS function

We've added a DC-voltage type with NPN and PNP transistor outputs all in one sensor. Its BGS / FGS function controls any background effects for more stable sensing.

Not affected by background objects

Because the sensor doesn't detect objects outside the preset sensing field by using the 2-segment photodiode adjustable range system, it will not malfunction even if someone walks behind the sensing object or machines or conveyors are in the background.

Impervious to variations color or angle

Due to its advanced optical system, the sensor is not affected by variations in the object's angle or gloss compared to conventional sensors. Moreover, as the difference in sensing range between black and white varies by only approx. 5 % (Note), sensing can be performed at a somewhat constant distance even if the sensing object is black or white.

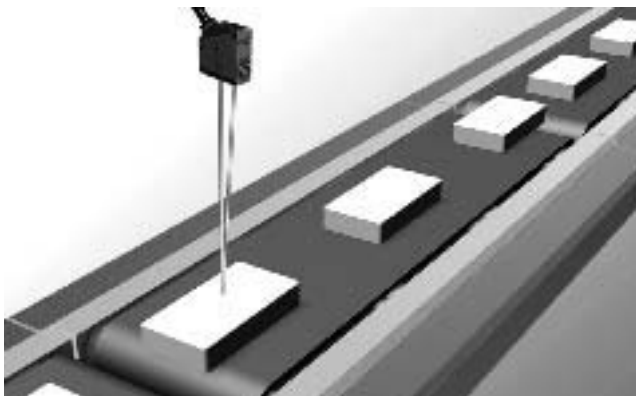

Refer to p.196 for the BGS / FGS functions.



Note: Example of the difference in sensing range between black non-glossy paper (Lightness: 5) and white non-glossy paper when the setting distance is set at 2 m 6.562 ft.

New

Introducing the 1 m 3.281 ft sensing range type!

Convenient timer function models

Types with an ON-delay / OFF-delay timer available.

OFF-delay, e.g. useful when the response of the connected device is slow, ON-delay, e.g. useful to detect objects that take a long time to move.

- Operation: ON-delay, OFF-delay
- Timer period: 0.1 to 5 sec.
(individual setting possible)

An easy to set adjuster with indicator

Equipped with a 2-turn adjuster with indicator, making it easy to set for short or long distances.

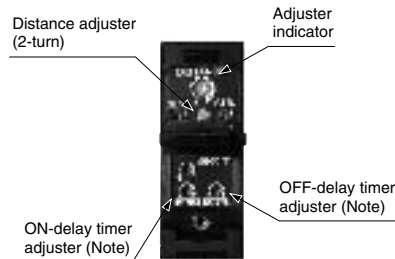

Convenient terminal block type

Cabling enabled by way of a terminal block that eliminates waste.

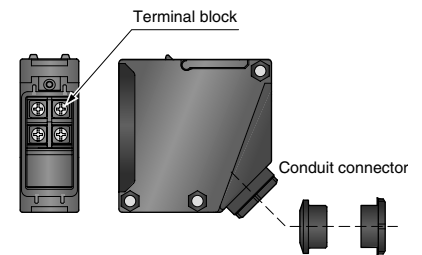

Stable sensing even in harsh environments prone to water or dust.

Little affected by contamination on lens

Even if the lens surface gets somewhat dirty from dust particles, there is very little change in the operation field, rendering stable and consistent detection even for objects appearing close to the front surface of the unit.

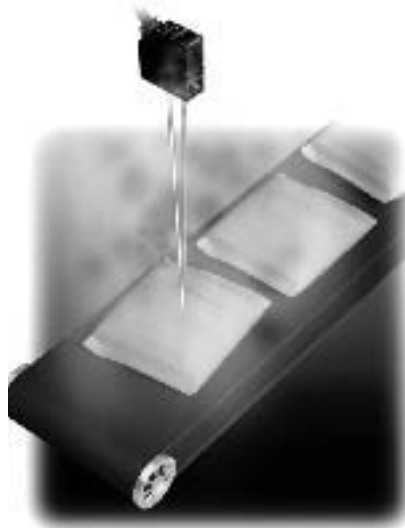

Waterproof

IP67 protection permits use in environments where water may splash.

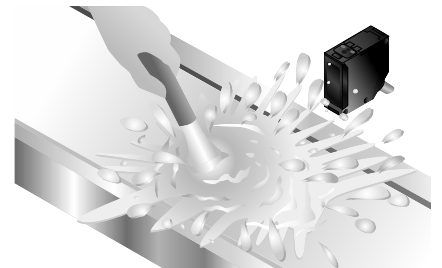

APPLICATIONS

Level check within the hopper

The distance to the object can be set to enable residual amount sensing in the hopper regardless of color.

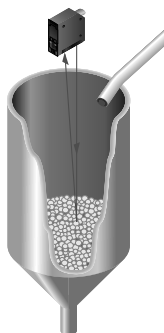

Confirmation of the passage of packages on a conveyor belt

Can accurately detect packages even if they vary in size and color.

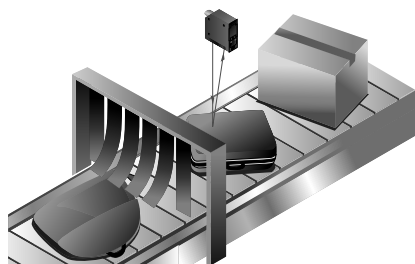

EQ-500

BGS / FGS FUNCTIONS MAKE EVEN THE MOST CHALLENGING SETTINGS POSSIBLE!

The BGS function is best suited for the following case

Background not present

When object and background are separated



BGS (Background suppression) function

The sensor judges that an object is present when light is received at position A of the light-receiving element (2-segment element). This is useful if the object and background are far apart. Not affected if the background color changes or someone passes behind the conveyor.

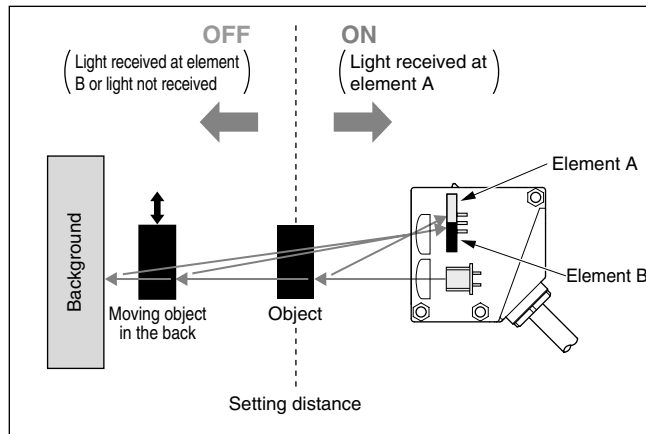

The FGS function is best suited for the following case

Background present

When object and background are close together
When the object is glossy or uneven

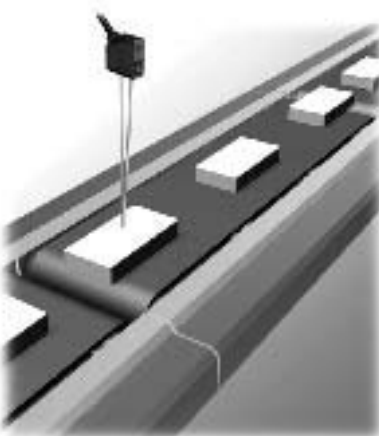



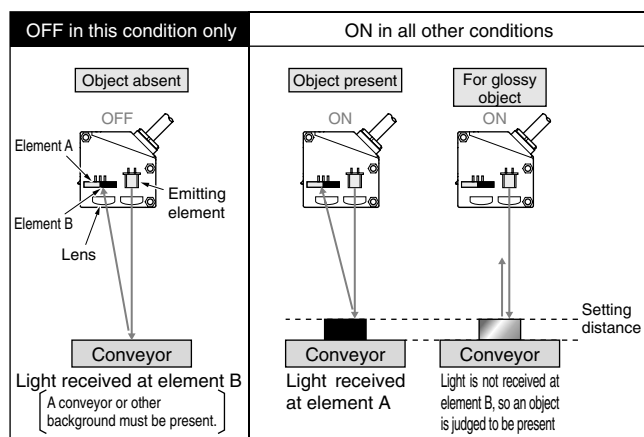

FGS (Foreground suppression) function

The sensor judges that no object is present when light is received at position B of the light receiving element (2-segment element) (The conveyor is detected). This function is useful if the object and the background are close together or if the object is glossy or uneven. However, sensing is impossible if there is no background (conveyor, etc.).

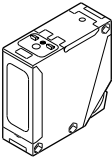

OPTIONS

Type	Appearance	Sensing range	Model No.	Supply voltage	Output	Timer function
Multi-voltage		 0.1 to 2.5 m 0.328 to 8.202 ft	EQ-501	24 to 240 V AC ± 10 % or 12 to 240 V DC ± 10 %	Relay contact 1a	—
			EQ-501T			ON-delay / OFF-delay timer (Timer period: 0.1 to 5 sec.)
		 0.1 to 1.0 m 0.328 to 3.281 ft	EQ-502			—
			EQ-502T			ON-delay / OFF-delay timer (Timer period: 0.1 to 5 sec.)
DC-voltage		 0.1 to 2.5 m 0.328 to 8.202 ft	EQ-511	12 to 24 V DC ± 10 %	NPN open-collector transistor PNP open-collector transistor (Equipped with) 2 outputs	—
			EQ-511T			ON-delay / OFF-delay timer (Timer period: 0.1 to 5 sec.)
		 0.1 to 1.0 m 0.328 to 3.281 ft	EQ-512			—
			EQ-512T			ON-delay / OFF-delay timer (Timer period: 0.1 to 5 sec.)

OPTION

Designation	Model No.	Description
Sensor mounting bracket	MS-EQ5-01	Foot / back angled mounting bracket

Sensor mounting bracket • MS-EQ5-01

Two M5 (length 30 mm 1.181 in) screws with washers and two nuts are attached.

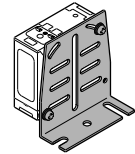

I/O CIRCUIT AND WIRING DIAGRAMS

EQ-501(T) EQ-502(T)

I/O circuit diagram

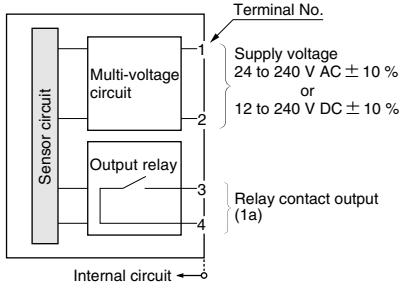

Terminal arrangement diagram

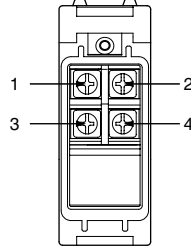

EQ-511(T) EQ-512(T)

I/O circuit diagram

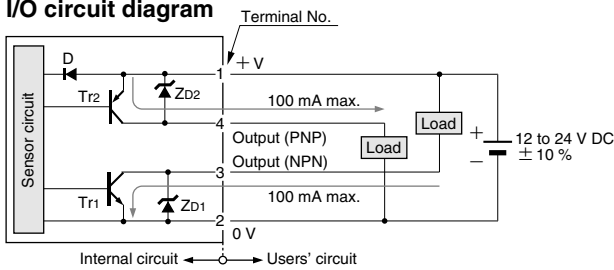

Terminal arrangement diagram

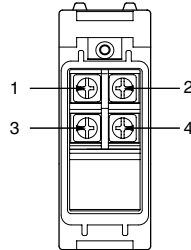

Symbols... D : Reverse supply polarity protection diode
Zd1, Zd2: Surge absorption zener diode
Tr1: NPN output transistor
Tr2: PNP output transistor

SENSING CHARACTERISTICS (TYPICAL)

EQ-501(T) EQ-511(T)

Sensing fields

• Setting distance: 1 m 3.281 ft

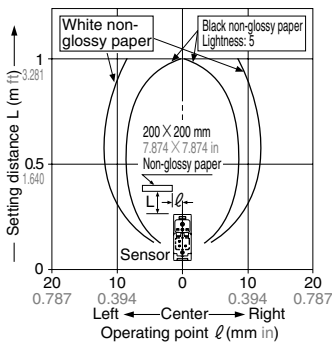

• Setting distance: 2.5 m 8.202 ft

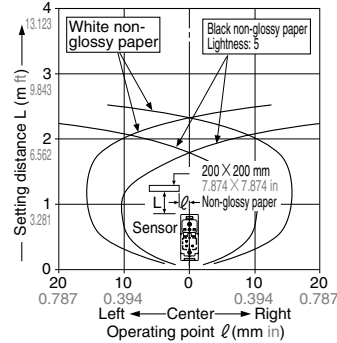

Correlation between material

(200 X 200 mm 7.874 X 7.874 in) and sensing range

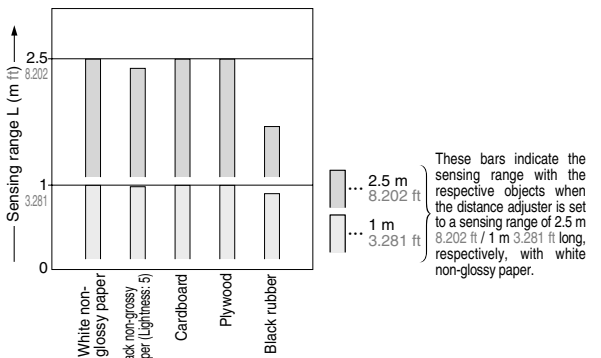

Correlation between color

(200 X 200 mm 7.874 X 7.874 in non-glossy paper) and sensing range

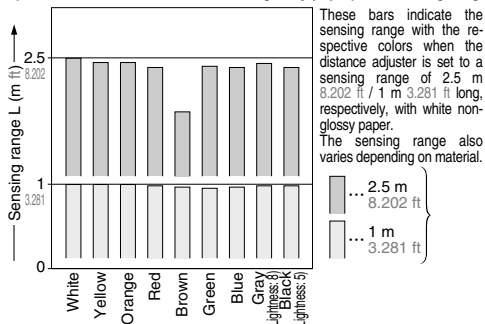

Emitted beam

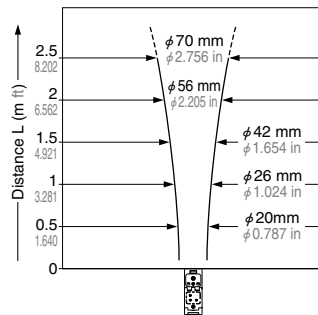

Correlation between sensing object size and sensing range

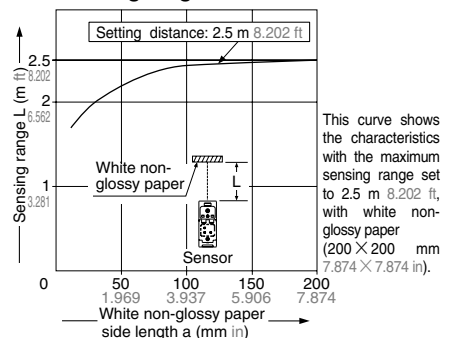

EQ-500

SENSING CHARACTERISTICS (TYPICAL)

EQ-502(T)
EQ-512(T)

Sensing fields

• Setting distance: 0.5 m 1.640 ft

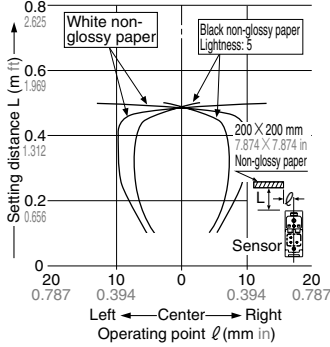

• Setting distance: 1 m 3.281 ft

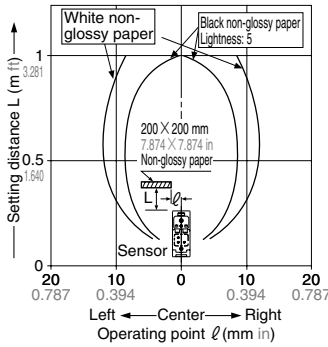

Correlation between material

(200 X 200 mm 7.874 X 7.874 in) and sensing range

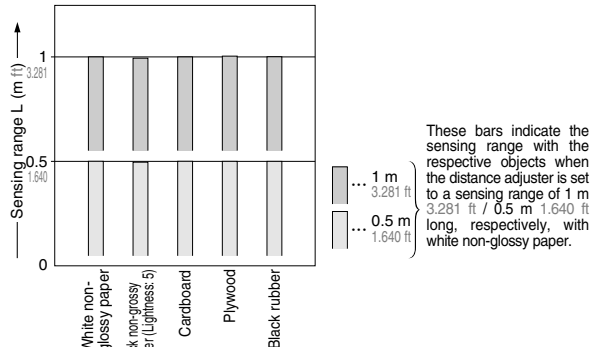

Correlation between color

(200 X 200 mm 7.874 X 7.874 in non-glossy paper) and sensing range

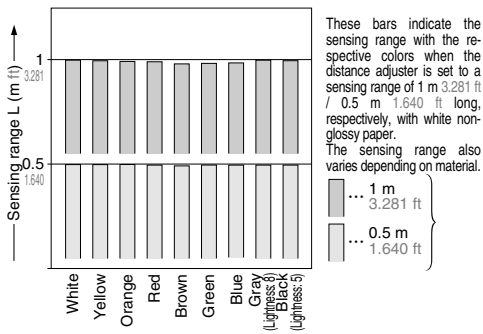

Emitted beam

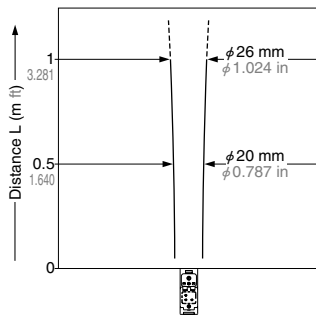

Correlation between sensing object size and sensing range

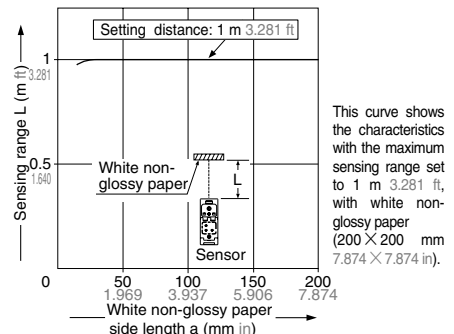

PRECAUTIONS FOR PROPER USE



This product is not a safety sensor. Its use is not intended or designed to protect life and prevent body injury or property damage from dangerous parts of machinery. It is a normal object detection sensor.

Mounting

• The tightening torque should be 0.8 N·m or less.

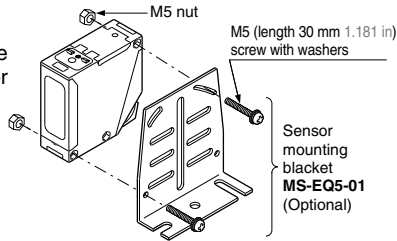

• Care must be taken regarding the sensor mounting direction with respect to the object's direction of movement.

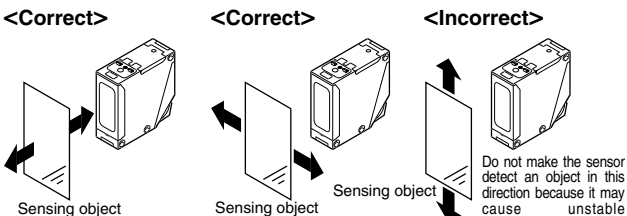

• When detecting a specular object (aluminum or copper foil, etc.) or an object having a glossy surface or coating, please note that there are cases when the object may not be detected due to a change in angle, wrinkles on the object surface, etc.

• If a specular body is present in the background, faulty operation may be caused due to a small change in the angle of the background body. In that case, install the sensor at an inclination and confirm the operation with the actual sensing object.

• When a specular body is present below the sensor, use the sensor by tilting it slightly upwards to avoid faulty operation.

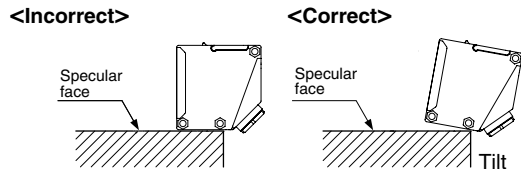

• This product is not easily affected by the reflected light intensity since this sensor is the adjustable range reflective type. When the reflected light intensity is remarkably low, the sensing range may be affected. In that case, mount the sensor, while checking light-up of the stable indicator (green).

• The mounting screws of the terminal cover and display cover should certainly be tightened to maintain water-resistance; the tightening torque of the screws should be 0.3 to 0.5 N·m.

Automatic interference prevention function

• When the sensors are mounted closely, use them in the interference prevented area, as shown below.

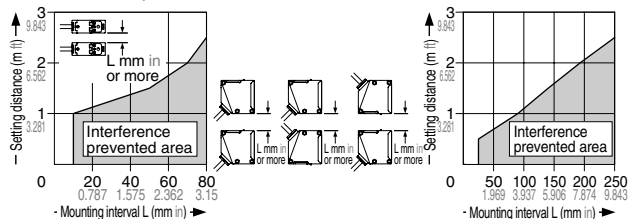

• Note that the detection may be unstable depending on the mounting conditions or the sensing object to be used. In the state that this product is mounted, be sure to check the operation with the actual sensing object to be used.

PRECAUTIONS FOR PROPER USE

Wiring

- Make sure that the power supply is off while wiring.
- Check all wiring before applying power since incorrect wiring may damage the internal circuit. Also, carefully tighten the terminal screws so that the wires of adjacent terminals do not touch.
- The mounting hole for the terminal cover fixing screws inclines 70 degrees to the terminal cover, as shown in the figure below. To avoid damaging this product or screw, take care when tightening or loosening a screw.

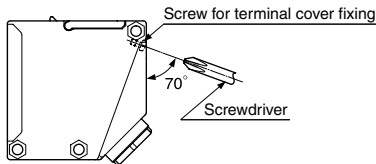

- To maintain water-resistance, the cable should have an outer diameter between $\phi 9$ to $\phi 11$ mm $\phi 0.354$ to $\phi 0.433$ in with a smooth covering material that allows the attached conduit connector to be securely tightened; the tightening torque of the screw should be of 1.5 to 2.0 N·m.
- Verify that the supply voltage variation is within the rating.
- If power is supplied from a commercial switching regulator, ensure that the frame ground (F.G.) terminal of the power supply is connected to an actual ground.
- In case noise generating equipment (switching regulator, inverter motor, etc.) is used in the vicinity of this sensor, connect the frame ground (F.G.) terminal of the equipment to an actual ground.
- Do not run the wires together with high-voltage lines or power lines or put them in the same raceway. This can cause malfunction due to induction.
- If an external surge voltage exceeding 4 kV is impressed (DC-voltage type: 1 kV), the internal circuit will be damaged, and a surge suppressing element should be used.
- Prepare the cable end as shown below.

Conduit connector construction and cabling

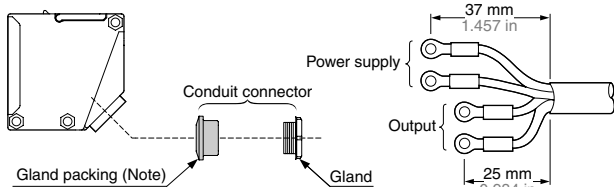

Note: When assembling the conduit connector, pay attention to the direction of the gland packing.

Furthermore, in order to maintain water-resistance, fit the gland packing such that the seating surface of the gland packing contacts the packing holder part of the terminal cover evenly.

- The size of conduit is M20 × 1.5.
- If pressure terminals are to be used, affix the connected pressure terminals to a terminal (M3.5 screw).

Dimensions of the suitable crimp terminals

(Unit: mm in)

	Round type	Y-shaped type

Note: Use crimp terminals with insulating sleeves.

Recommended crimp terminal: Nominal size 1.25 × 3.5 0.049 × 0.138.

- The tightening torque for the terminal screws should be 0.3 to 0.5 N·m.

Part description

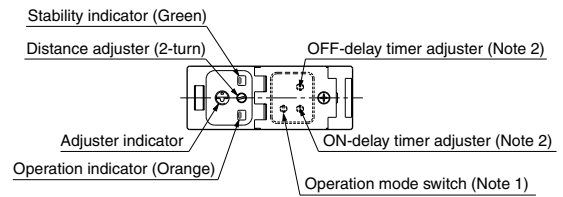

Notes: 1) The operation mode switch of the DC-voltage type is the DIP switch. Refer to 'DC-voltage type' of 'Operation mode switch' for details.

2) Incorporated on EQ-5□T only.

Operation mode switch

Multi-voltage type (L-ON / D-ON mode only)

Operation mode switch	Description
	Detection-ON mode is obtained when the switch is turned fully clockwise (L side).
	Detection-OFF mode is obtained when the switch is turned fully counterclockwise (D side).

Note: Turn the operation mode switch gradually and lightly with the attached screwdriver. Turning with excessive strength will cause damage to the adjuster.

DC-voltage type

L-ON / D-ON mode	→ L		D
BGS / FGS mode	→ BGS		FGS
Timer mode	→ OFF		Timer ON
Not used	→ N.C.		N.C.

BGS / FGS function (DC-voltage type only)

- DC-voltage type sensor incorporates BGS / FGS function. Select either the BGS or FGS function depending on the positions of the background and sensing object.
- BGS / FGS function is set with the operation mode switch.
- Depends on a selection of either BGS or FGS function, the output operation changes as follows.

		Detectable range	Setting distance	Non-detectable area	
BGS	L-ON				ON OFF
	D-ON				ON OFF
FGS	L-ON				ON OFF
	D-ON				ON OFF

EQ-500



PRECAUTIONS FOR PROPER USE

Distance adjustment



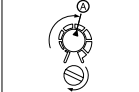

• For DC-voltage type, be sure to set the BGS / FGS function before distance adjustment. If the setting is done after the distance adjustment, the sensing area is changed.

• Turn the distance adjuster gradually and lightly with the attached adjusting screwdriver. Turning with excessive strength will cause damage to the adjuster.

Multi-voltage type, DC-voltage type • BGS select

Step	Description	Distance adjuster
①	Turn the distance adjuster fully counterclockwise to the minimum sensing range position. (0.2 m 0.656 ft approx.)	 Turn fully
②	Place an object at the required distance from the sensor, gradually turn the distance adjuster clockwise to determine point ①, where the sensor changes to the detecting state.	
③	Remove the object. Continue turning the adjuster clockwise until the sensor enters the detecting state again. Then turn the distance adjuster back a little until the sensor returns to the non-detecting state, called point ②. (If the sensor does not go into the detecting state even if the adjuster is turned fully clockwise, point ② is regarded as the maximum position on the scale.)	
④	The optimum position to stably detect objects is the center point between ① and ②.	 Optimum position

DC-voltage type • FGS select

Step	Description	Distance adjuster
①	Turn the distance adjuster fully clockwise to the maximum sensing range position. (2.5 m 8.202 ft approx., 1.0 m 3.281 ft approx. for EQ-512□)	 Turn fully
②	In the state where the sensor detects the background, gradually turn the distance adjuster counterclockwise, to determine point ① where the sensor changes to the non-detecting state.	
③	Place an object at the required distance from the sensor, turn the adjuster counterclockwise further until the sensor goes into the non-detecting state again. Once entered, turn the adjuster backward a little until the sensor returns to the detecting state, called point ②. (If the sensor does not go into the non-detecting state even if the adjuster is turned fully counterclockwise, point ② is regarded as the maximum position on the scale.)	
④	The optimum position to stably detect objects is the center point between ① and ②.	 Optimum position

Timer function (EQ-5□T only)

- EQ-5□T incorporates an OFF-delay timer, which is useful when the response of the connected device is slow, etc., and an ON-delay timer, which is useful for detecting objects that move slowly, for example.
- The OFF-delay and ON-delay timers can be used simultaneously.
- For DC-voltage type, set the DIP switch for the timer mode to 'Timer ON' side.

Time chart

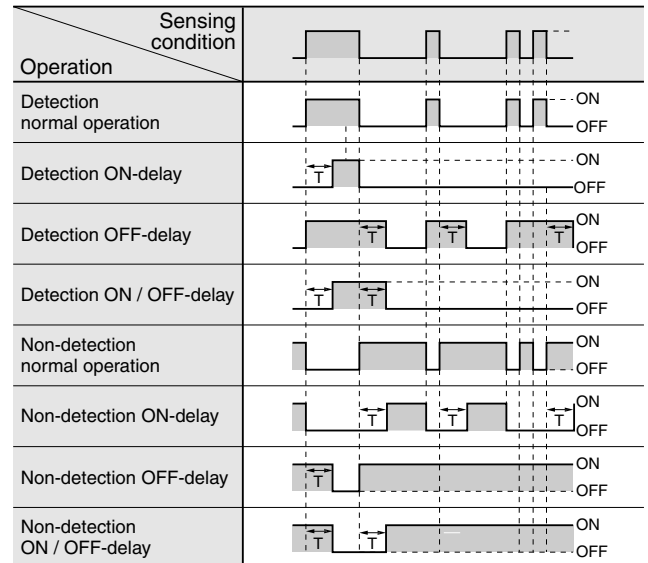

Stability indicator

- Since the EQ-500 series uses a 2-segment photodiode as its receiving element, and sensing is done based on the difference in the incident beam angle of the reflected beam from the sensing object, the output and the operation indicator (orange) operate according to the object distance. Furthermore, the stability indicator (green) shows the margin of the setting distance.

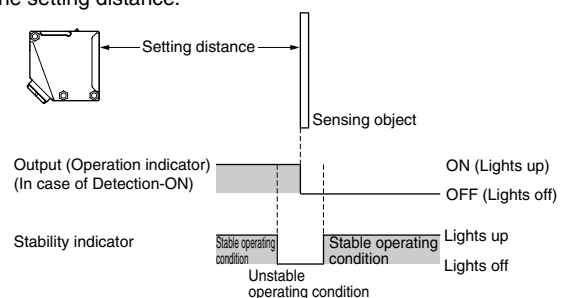

Others

- Take care that the sensor is not directly exposed to fluorescent light from a rapid-starter lamp or a high frequency lighting device, as it may affect the sensing performance.
- Do not use during the initial transient time (50 ms) after the power supply is switched on.
- This sensor is suitable for indoor use only.
- Its distance adjuster is mechanically operated. Do not drop; avoid other shocks.
- Do not use this sensor in places having excessive vapor, dust, etc., or where it may come in direct contact with water, or corrosive gas.
- Take care that the sensor does not come in direct contact with water, oil, grease or organic solvents, such as, thinner, etc.
- This sensor cannot be used in an environment containing inflammable or explosive gases.
- Never disassemble or modify the sensor.

DIMENSIONS (Unit: mm in)

EQ-501(T) EQ-502(T)
EQ-511(T) EQ-512(T) Sensor

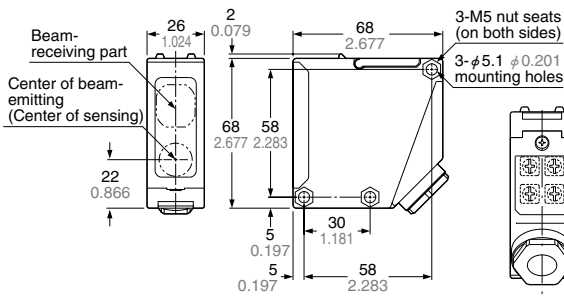
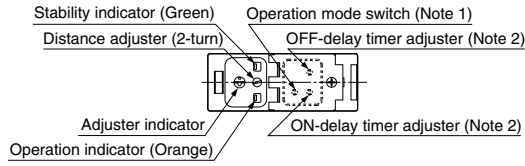

Notes: 1) The operation mode switch of the DC-voltage type is the DIP switch.
2) EQ-5□T does not incorporate those.

Assembly dimensions with sensor mounting bracket MS-EQ5-01 (Optional) (Foot angled mounting)

