





Direct-acting 2/2 or 3/2-way pivoted armature valve

- Direct-acting, media-separated valve up to DN 5
- Maintenance-free pivoted armature technology
- Vibration-proof, block screwed coil system
- Service-friendly, robust manual override
- Explosion-proof variants



Product variants described in the data sheet may differ from the product presentation and description.

Can be combined with

	Type 1087 Timer	▶
	Type 2518 Cable Plug DIN EN 175301 - 803 - Form A	▶

Type description

The 0330 valve is a direct-acting, media-separated pivoted armature valve. It is available as a 2/2 and 3/2-way variant. As a 3/2-way variant, it can be used as a distributor or mixing valve. Various diaphragm materials and circuit functions are available depending on the actual application. The standard brass body meets all European drinking water requirements. Stainless steel (316L), PVDF, and polypropylene bodies complete the offering. The solenoid coils are moulded with a chemically resistant epoxy. Since the coil system is separated from the medium by a diaphragm, the valve is especially suitable for critical media such as aggressive acids and lyes. The 0330 is equipped with manual override for start-up and testing. To reduce energy demands, all the coils can be delivered with electronic power reduction or as an impulse variant. The switching status can be indicated via position feedback as a binary or NAMUR signal. In combination with a plug to DIN EN 175301-803 Form A, the valves satisfy degree of protection IP65/67 – and NEMA 4X when combined with a stainless steel or plastic valve body.

Table of contents

1. General Technical Data	3
2. Circuit functions	4
3. Materials	5
3.1. Chemical Resistance Chart – Bürkert resistApp.....	5
3.2. Material specifications	5
4. Dimensions	6
4.1. Standard version.....	6
Metal housing	6
Plastic housing.....	7
4.2. Explosion proof version	8
5. Device/Process connections	9
5.1. PIN assignment standard version.....	9
5.2. PIN assignment explosion proof version	9
6. Performance specifications	10
6.1. Pressure range and flow rate	10
Standard version.....	10
Use in other circuit functions	10
Explosion proof version	11
Use in other circuit functions	11
7. Product accessories	12
7.1. Accessories standard version.....	12
7.2. Accessories explosion proof version.....	12
7.3. Cable glands for ATEX/IECEx terminal box	13
7.4. Special tool to turn the junction box.....	13
8. Ordering information	14
8.1. Bürkert eShop – Easy ordering and quick delivery.....	14
8.2. Bürkert product filter	14
8.3. Ordering chart.....	14
Standard version.....	14
Explosion proof version	16
8.4. Ordering chart accessories.....	17
Cable plug Type 2518, Form A according to DIN EN 175301 - 803	17
Cable glands for ATEX/IECEx terminal box	17
Mounting plate cpl. for DIN rail mounting.....	17
Locking ring	17

1. General Technical Data

Product properties	
Dimensions	Detailed information can be found in chapter "4. Dimensions" on page 6.
Material	
Seal	EPDM / FKM / FFKM / NBR
Body	Brass Stainless steel (1.4401) PP (Polypropylene) PVDF (Polyvinylidene fluoride)
Material resistance	More detailed information can be found in our resistance table, "3.1. Chemical Resistance Chart – Bürkert resistApp" on page 5.
Weight	Metal body 0.47 kg Plastic body 0.40 kg
Orifice	DN 2...DN 5
Thermal insulation class of solenoid coil	H
Performance data	
Duty cycle	
With brass and stainless steel	100 %
With PP and PVDF	40 % duty cycle (60 % intermittent operation) in 30 min for 8 W version 100 % duty cycle for 5 W version
Max. cycling rate (explosion proof version)	Medium temperature up to +70 °C: 20/min Medium temperature up to +90 °C: 5/min
Switching times¹⁾ standard version	
Frequency AC	Opening: 8...15 ms Closing: 8...15 ms
Frequency DC	Opening: 10...20 ms Closing: 10...20 ms
Switching times¹⁾ explosion proof version	
Orifice 2...4	Opening: 30 ms Closing: 40 ms
Electrical data	
Voltage tolerance	± 10 %
Power consumption standard	
Frequency AC	Inrush: 30 VA Hold: 15 VA Hold: 8 W
Frequency DC	Cold: 11 W Warm: 8 W
Power consumption Impulse (inrush winding)	
Frequency AC	Hold: 20 VA Hold: 11 W
Frequency DC	Cold: 11 W Warm: 8 W
Power consumption explosion proof version	
Frequency AC/DC	Inrush: 40 W Hold: 3 W
Voltages	
Standard version	24 V 50 Hz, 110 V 50 Hz, 230 V 50 Hz, 120 V 60 Hz, 240 V 60 Hz, 12 V DC, 24 V DC (further voltages on request)
Explosion proof version	24 V, 230 V (further voltages on request)

Medium data	
Viscosity	Max. 37 mm ² /s
Operating medium	
With NBR	Neutral medium such as compressed air, town gas, water, hydraulic oil, oils and fats without additives, oxygen
With EPDM	Alkalis, acids to medium concentrations, alkaline washing and bleaching lyes
With FKM	Oxydizing acids and substances, hot oils with additives, salt solutions, waste gases, oxygen
With FFKM	Aggressive mediums, hot air, hot oils
Medium temperature	
With body material brass or stainless steel	NBR: 0 °C...+80 °C EPDM: -30 °C...+90 °C FKM: 0 °C...+90 °C FFKM: +5 °C...+90 °C
With body material PP or PVDF	NBR: 0 °C...+80 °C EPDM: -30 °C...+80 °C FKM: 0 °C...+80 °C FFKM: +5 °C...+80 °C
Process/Port connection & communication	
Port connection	G ¼, NPT ¼, (RC ¼ and G ½ on request, G ½ not possible for PP and PVDF)
Electrical connection	
Standard version	Pin terminal acc. to DIN EN 175301 - 803 Form A for cable pug Type 2518/2509 (also on request with moulded cable or terminal box)
Explosion proof version	Moulded cable (for more detailed information, refer to the operating manual ACP016), terminal box without safety fuse
Approvals and certificates	
Standard version	
Degree of protection	IP65 with cable plug
Explosion proof version	
Degree of protection	IP65
Type of protection	II 2 G Ex mb IIC T4 Gb II 2 D EX mb IIIC T130°Db
Certificate	EPS 16 ATEX 1 111 X IECEX EPS 16.0049X
Environment and installation	
Installation position	As required, preferably with actuator upright
Ambient temperature (max.)	
Standard version	+55 °C
Explosion proof version	+40 °C

1.) Measured at valve outlet at 6 bar and +20 °C. Opening: pressure rise 0...90 %, closing: pressure drop 100...10 %

2. Circuit functions

Circuit functions	Description
	Type: A, solenoid valve 2/2 way Direct-acting Normally closed
	Type: B, solenoid valve 2/2 way Direct-acting Normally opened
	Type: C, solenoid valve 3/2 way Direct-acting Normally closed

DTS 1000079488 EN Version: Y Status: RL (released | freigegeben | valide) printed: 02.02.2021

Circuit functions	Description
	Type: D, solenoid valve 3/2 way Direct-acting Normally opened
	Type: E, mixing valve (solenoid valve) 3/2 way
	Type: F, distribution valve (solenoid valve) 3/2 way Direct-acting
	Type: T, solenoid valve 3/2 way Direct-acting Flow direction optional

3. Materials

3.1. Chemical Resistance Chart – Bürkert resistApp

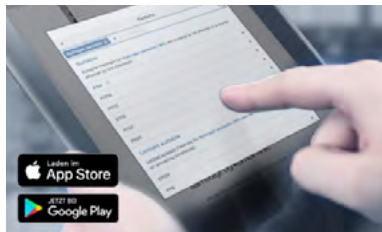

Bürkert resistApp – Chemical Resistance Chart

You want to ensure the reliability and durability of the materials in your individual application case? Verify your combination of media and materials on our website or in our resistApp.

[Start Chemical Resistance Check](#)

3.2. Material specifications

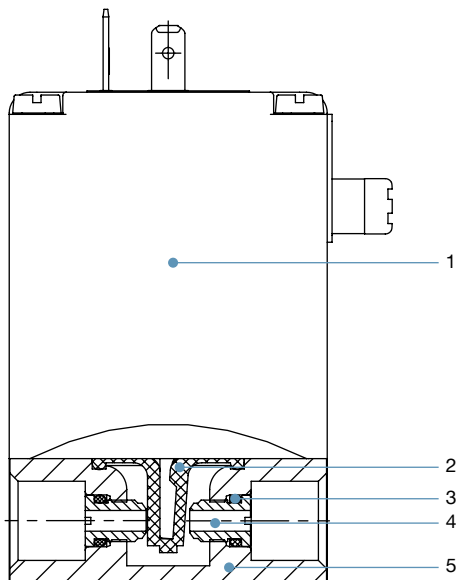

No.	Element	Material
1	Coil	Epoxy
2	Diaphragm	EPDM, FKM, FFKM, NBR
3	O-ring	EPDM, FKM, FFKM, NBR
4	Seat	Brass Stainless steel (1.4401) PP (Polypropylene) PVDF (Polyvinylidene fluoride)
5	Valve body	Brass Stainless steel (1.4401) PP (Polypropylene) PVDF (Polyvinylidene fluoride)

4. Dimensions

4.1. Standard version

Note:

- Dimensions in mm
- The dimensions D1 and L1 apply to G-threads.
- The dimensions D2 and L2 apply to NPT-threads.
- For metal housings, the minimum thread length at the middle connection is 7.5 mm.
- Mounting device: By drilling M4 × 8 (metal housing) or self-tapping screws (plastic housing) on underside of the housing on the hole pattern 38 × 24.
- The dimensions of the cable plug Type 2518 can be found in chapter “8.4. Ordering chart accessories” on page 17.

Metal housing

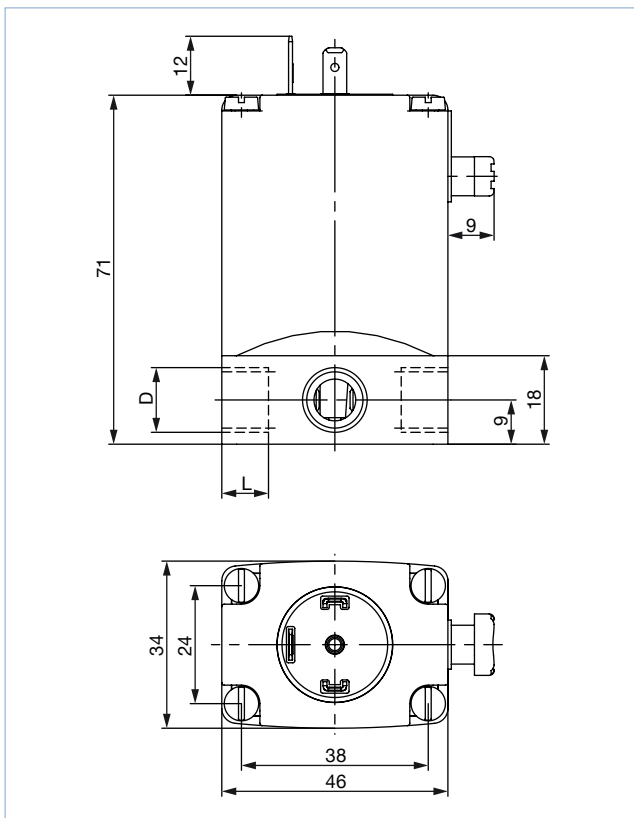

D1	L1	D2	L2
G 1/8	9	-	-
G 1/4	9	NPT 1/4	7.5

Plastic housing

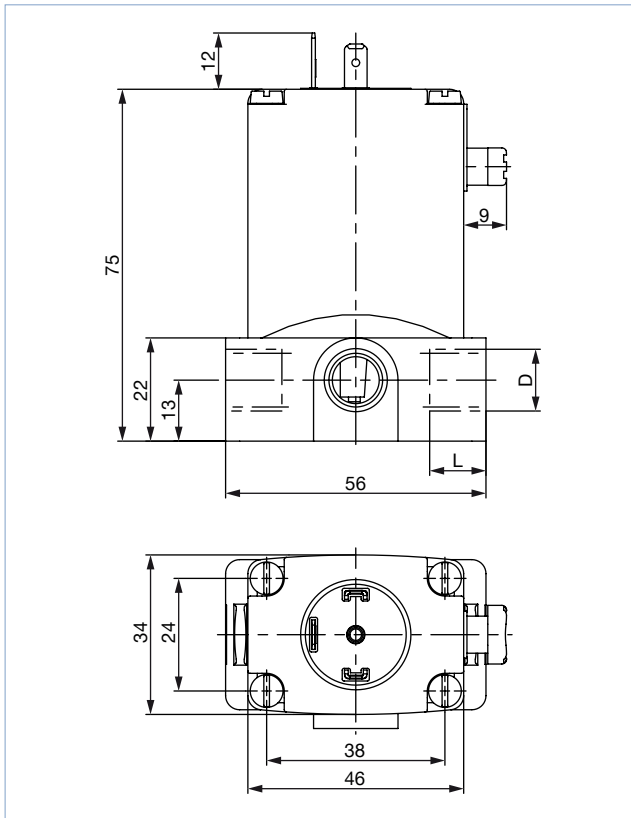

D	L
G ¼	12
NPT ¼	11

4.2. Explosion proof version

Note:

- Dimensions in mm
- The dimensions D1 and L1 apply to G-threads.
- The dimensions D2 and L2 apply to NPT-threads.

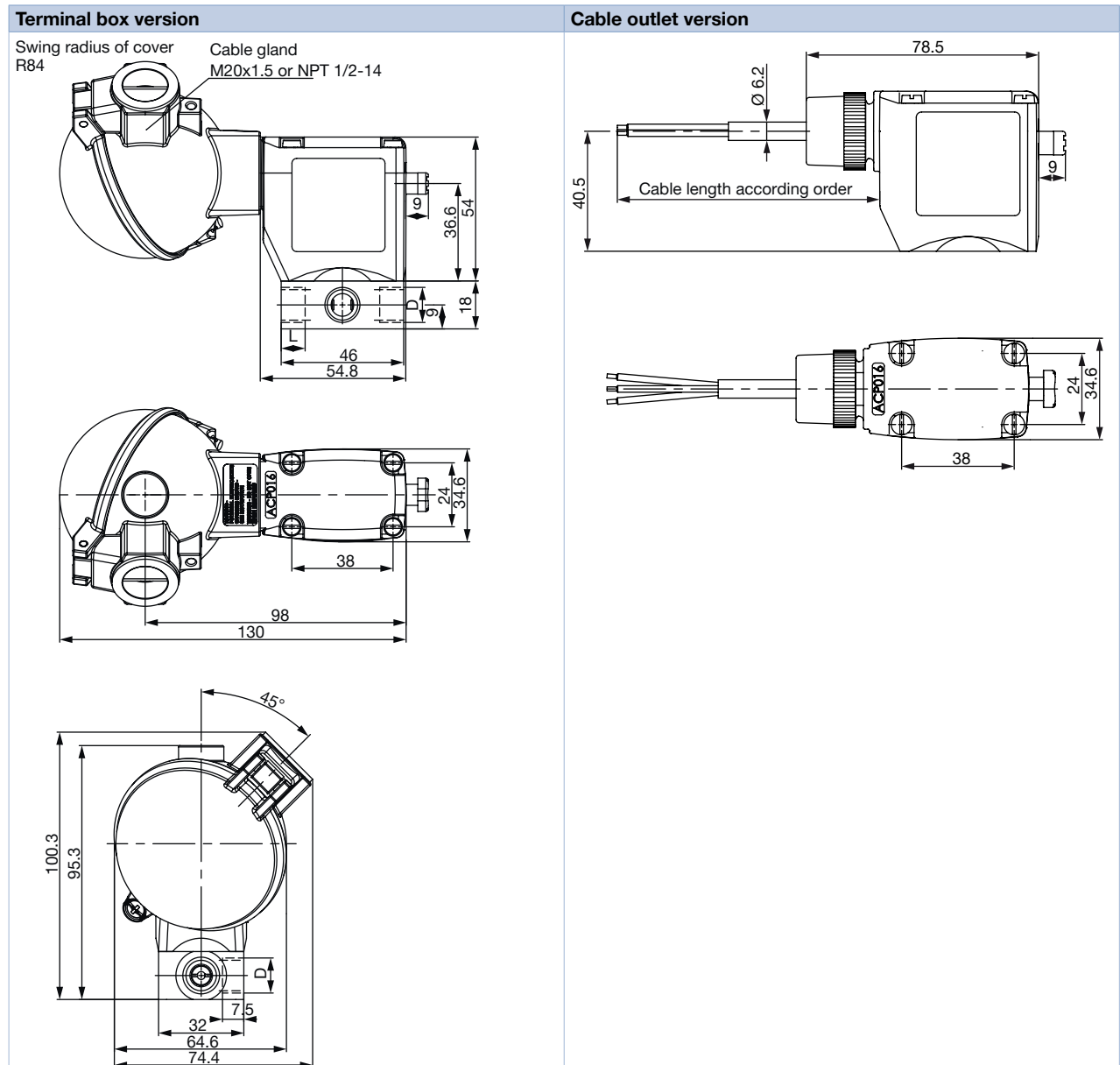

D1	L1	D2	L2
G 1/8	9	-	-
G 1/4	9	NPT 1/4	7.5

DTS 1000079488 EN Version: Y Status: RL (released | freigegeben | valide) printed: 02.02.2021

5. Device/Process connections

5.1. PIN assignment standard version

Note:

The pin assignment (marked No. 1, 2 and 3 in the drawing) depends on the circuit function. In the table, compare the respective pin assignment with the corresponding circuit function.

Circuit function	Connection 1	Connection 2	Connection 3	2 way	3 way
A	P	A	-		
B	B	P	-		
C	P	A	R		
D	R	B	P		
E	P1	A	P2		
F	A	P	B		
T	NC	I _N /OUT	NO		

5.2. PIN assignment explosion proof version

Note:

The pin assignment (marked No. 1, 2 and 3 in the drawing) depends on the circuit function. In the table, compare the respective pin assignment with the corresponding circuit function.

Circuit function	Connec-tion 1	Connec-tion 2	Connec-tion 3	2 way	3 way
A	P	A	-		
B	B	P	-		
C	P	A	R		
D	R	B	P		
E	P1	A	P2		
F	A	P	B		
T	NC	I _N /OUT	NO		

6. Performance specifications

6.1. Pressure range and flow rate

Standard version

Circuit function	DN	K _v value water		Pressure range ^{1.)}		
		DC	AC (50 or 60 Hz)	Standard ^{2.)}	Vacuum ^{3.)}	Impulse ^{4.)}
		[m ³ /h]	[m ³ /h]	[bar]	[bar]	[bar]
Metal body						
A / B / C / D / F	2.0	0.08	0.11	0...16 ^{5.)}	-0.98...10	0...16 ^{5.)}
	3.0	0.14	0.18	0...10	-0.98...6	0...10
	4.0	0.17	0.23	0...5	-0.98...3	0...5
	5.0	0.29	0.29	0...2.5	-0.98...1	0...2.5
E	2.0	0.08	0.11	0...10	-0.98...8	0...10
	3.0	0.14	0.18	0...6	-0.98...5	0...6
	4.0	0.17	0.23	0...3	-0.98...2.5	0...3
	5.0	0.29	0.29	0...1.5	-0.98...1	0...1
T	2.0	0.08	0.11	0...12	-0.98...8	0...10
	3.0	0.14	0.18	0...8	-0.98...5	0...6
	4.0	0.17	0.23	0...4	-0.98...2.5	0...5
	5.0	0.29	0.29	0...2.5	-0.98...1	-

Circuit function	DN	K _v value water ^{6.)} [m ³ /h]	Pressure range ^{1.)}			
			Standard ^{2.)} AC [50 or 60 Hz] [bar]	Standard ^{2.)} DC [bar]	Vacuum ^{3.)} [bar]	Impulse ^{4.)} [bar]
			Plastic body			
A / B / C / D / F	2.0	0.13	0...16 ^{5.)}	0...12	-0.98...10	0...12
	3.0	0.25	0...10	0...8	-0.98...6	0...8
	4.0	0.30	0...5	0...4	-0.98...3	0...4
	5.0	0.40	0...4.5	0...3	-0.98...1	0...3
E / T	2.0	0.13	0...10	0...7	-0.98...7	0...7
	3.0	0.25	0...6	0...4	-0.98...5	0...4
	4.0	0.30	0...3	0...2	-0.98...2.5	0...2

1.) Pressure values with respect to atmospheric pressure (deviating pressure range for 5 W version)

2.) Rated power consumption 8 W

3.) Vacuum possible for all seal materials

4.) Inrush power 11 W

5.) For seal material FKM and FFKM the max. medium pressure is 12 bar

6.) At frequency DC the K_v value is reduced till 10 % to fulfil the function

Use in other circuit functions

The compression springs installed in the valves differ depending on the circuit function. When used in other circuit functions, the permissible operating pressure changes according to the following table.

Circuit function	Max. operating pressure [bar] when using the valve in a new circuit function																	
	Orifice DN 2						Orifice DN 3						Orifice DN 4					
	A ^{1.)}	B ^{1.)}	C	D	E	F	A	B	C	D	E	F	A	B	C	D	E	F
Metal body (8 W respectively 11 W)																		
C	16	1.5	16	1.5	1.5	16	10	1	10	1	1	10	5	0.8	5	0.8	0.8	5
D	4	16	4.5	16	4	4	2.5	10	2.5	10	2	3	2	5	2	5	2	2
T	8	8	10	10	10	8	6	6	6	6	6	6	3	3	3	3	3	3
Plastic body (8 W respectively 11 W)																		
C	16	1.5	16	1.5	1.5	16	10	1	10	1	1	10	5	0.8	5	0.8	0.8	5
D	4	16	4.5	16	4	4	2.5	10	2.5	10	2	3	2	5	2	5	2	2
F	16	1.5	10	1.5	1.5	16	6	1	6	1	1	10	4	1	4	1	1	5

1.) For circuit function A and B the valve must be connected acc. to the pin assignment of 3/2 way valve.

Explosion proof version

Circuit function	DN	K _v value water [m ³ /h]	Pressure range ^{1.) 2.)}	
			Standard	Vacuum
			[bar]	[bar]
Metal body				
A / B / C / D / F	2.0	0.11	0...16	-0.98...10
	3.0	0.18	0...10	-0.98...6
	4.0	0.23	0...5	-0.98...3
	5.0	0.29	0...4	-0.98...2.5
E	2.0	0.11	0...10	-0.98...8
	3.0	0.18	0...6	-0.98...5
	4.0	0.23	0...3.5	-0.98...2.5
	5.0	0.29	0...3	-0.98...2
T	2.0	0.11	0...10	-0.98...8
	3.0	0.18	0...6	-0.98...5

Circuit function	DN	K _v value water [m ³ /h]	Pressure range ^{1.) 2.)}	
			Standard	Vacuum
			[bar]	[bar]
Plastic body				
A / B / C / D / F	2.0	0.13	0...16	-0.98...10
	3.0	0.25	0...10	-0.98...6
	4.0	0.30	0...5	-0.98...3
	5.0	0.40	0...4.5	-0.98...1
E / T	2.0	0.13	0...10	-0.98...7
	3.0	0.25	0...6	-0.98...5
	4.0	0.30	0...3	-0.98...2.5

1.) Devices with FKM or FFKM diaphragm are reduced to a max. pressure of 12 bar.

2.) Pressure data: Measured as overpressure to the atmospheric pressure

Use in other circuit functions

The compression springs installed in the valves differ depending on the circuit function. When used in other circuit functions, the permissible operating pressure changes according to the following table.

Circuit function	Max. operating pressure [bar] when using the valve in a new circuit function																	
	Orifice DN 2						Orifice DN 3						Orifice DN 4					
	A ^{1.)}	B ^{1.)}	C	D	E	F	A	B	C	D	E	F	A	B	C	D	E	F
Metal body (8 W respectively 11 W)																		
C	16	1.5	16	1.5	1.5	16	10	1	10	1	1	10	5	0.8	5	0.8	0.8	5
D	4	16	4.5	16	4	4	2.5	10	2.5	10	2	3	2	5	2	5	2	2
T	8	8	10	10	10	8	6	6	6	6	6	6	3	3	3	3	3	3
Plastic body (8 W respectively 11 W)																		
C	16	1.5	16	1.5	1.5	16	10	1	10	1	1	10	5	0.8	5	0.8	0.8	5
D	4	16	4.5	16	4	4	2.5	10	2.5	10	2	3	2	5	2	5	2	2
F	16	1.5	10	1.5	1.5	16	6	1	6	1	1	10	4	1	4	1	1	5

1.) For circuit function A and B the valve must be connected acc. to the pin assignment of 3/2 way valve.

7. Product accessories

7.1. Accessories standard version

Option	Variable Code	Description
Impulse version	CF02	Bistable magnetic system with inrush and drop-off coil; continuous operation or operation with short current pulses (min. 150 ms) possible
Oxygen versions	NL02	Suitable for applications with oxygen (non-metal materials that are in contact with the medium, are tested and approved according to BAM)
Increased purity requirements e.g. oil, grease and silicone-free	NL50/NL05	Wetted parts are specially cleaned and packaged in accordance with the valves
Increased tightness requirements	PCxx	Standard units are tested at 10^{-2} mbar x l/sec; feasible up to 10^{-6} mbar
Electrical feedback	LF02/LF03	See Type 1060 ▶. Function as opener, closer or toggle switch depending on the connection (no IP65 achievable)
High-power electronics	CZ05	Inrush power 60 W, nominal holding current 3 W; with plastic versions 100 % duty cycle is now feasible
Vacuum version	NA02	Suitable for vacuums up to -0.98 bar
Increased purity and tightness requirements	NA03	Wetted parts are specially cleaned and leak tested to 10^{-4} mbar x l/sec
Increased purity and tightness requirements and vacuum version	NA01	Wetted parts are specially cleaned and leak tested up to 10^{-4} mbar x l/sec and suited for vacuum up to -0.98 bar
Coil with reduced power (5 W)	–	Devices have lower pressure range; with plastic versions 100 % duty cycle is now feasible
Cable plug	JHxx/JGxx/ JFxx	Cable plug is part of the delivery. Cable plug versions (acc. to DIN EN 175301-803 Form A), see datasheet Type 2518 ▶ and Type 2509 ▶
Approvals	PD01	CSA General Purpose valve
	PD02	UR (UL-recognized)/CSA approval
	PD07	DNV-GL (formerly Germanischer Lloyd)
	PR05	cFMus approved coil Class I, Division 1, Groups A, B, C and D - T4 Class II, Division 1, Groups E, F and G - T4 Class III, Division 1 - T4 Class I, Zone 1, AEx mb IIC T4 Gb, Zone 21 AEx mb IIIC T130 C Db Ex mb IIC T4 Gb; Ex mb IIIC T130 C Db
	PE95	UL (UL-listed) approval
	PU15	UL listed for Hazardous Locations for USA and Canada, Class I, Zone 1, AEx eb mb IIC T4; Zone 21, AEx mb tb IIIC T130 °C / Class I, Div 2, Group A,B,C,D; Class II+III, Div 2, Group F,G
PX41	EPS 16 ATEX 1111 X/IECEx EPS 16.0049X, 2G T4 IIC/2D T130 °C IIIC, Tamb -40 °C bis +60 °C, single and block mounting	
Possible conformities (depending on the assembly)	–	EAC, drinking water, FDA



7.2. Accessories explosion proof version

Option	Variable Code	Description
Oxygen versions	NL02	Suitable for applications with oxygen (non-metal materials that are in contact with the medium, are tested and approved according to BAM)
Increased purity requirements e.g. oil, grease and silicone-free	NL50/NL05	Wetted parts are specially cleaned and packaged in accordance with the valves
Increased hermetic requirements	PCxx	Standard units are tested at 10^{-2} mbar x l / sec; feasible up to 10^{-6} mbar
Vacuum version	NA02	Suitable for vacuums up to -0.98 bar
Increased purity and hermetic requirements	NA03	Wetted parts are specially cleaned and leak tested to 10^{-4} mbar x l/sec
Increased purity and hermetic requirements and vacuum version	NA01	Wetted parts are specially cleaned and leak tested up to 10^{-4} mbar x l/sec and suited for vacuum up to -0.98 bar
Electrical feedback	CF15	Coil with intrinsically safe proximity switches (PTB 00 ATEX 2048X) instead of manual override

7.3. Cable glands for ATEX/IECEx terminal box

Note:

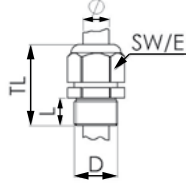
A cable gland in polyamide version is included in the delivery. A nickel-plated brass version can be ordered at a surcharge, see “8.4. Ordering chart accessories” on page 17.

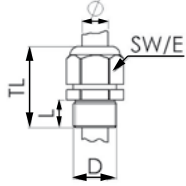
Description	Ex approvals		Dimensions										
	Certification	Identification											
Ex cable gland, Brass, nickel-plated, 6...13 mm 	PTB 04 ATEX 1112 X, IECEx PTB 13.0027X	II 2 G Ex e IIC Gb, II 2 D Ex tb IIIC Db IP68	 <table border="1"> <tr><td>TL</td><td>29...37 mm</td></tr> <tr><td>L</td><td>6 mm</td></tr> <tr><td>D</td><td>20 mm</td></tr> <tr><td>SW</td><td>24 mm</td></tr> <tr><td>E</td><td>27 mm</td></tr> </table>	TL	29...37 mm	L	6 mm	D	20 mm	SW	24 mm	E	27 mm
TL	29...37 mm												
L	6 mm												
D	20 mm												
SW	24 mm												
E	27 mm												
Ex cable gland, Polyamide, 7...13 mm 	PTB 13 ATEX 1015 X, IECEx PTB 13.0034X	II 2 G Ex e IIC Gb, II 2 D Ex tb IIIC Db IP68	 <table border="1"> <tr><td>TL</td><td>36...45 mm</td></tr> <tr><td>L</td><td>10 mm</td></tr> <tr><td>D</td><td>20 mm</td></tr> <tr><td>SW</td><td>24 mm</td></tr> <tr><td>E</td><td>28 mm</td></tr> </table>	TL	36...45 mm	L	10 mm	D	20 mm	SW	24 mm	E	28 mm
TL	36...45 mm												
L	10 mm												
D	20 mm												
SW	24 mm												
E	28 mm												

7.4. Special tool to turn the junction box

Note:

This special tool is not supplied with the valve (see “8.4. Ordering chart accessories” on page 17).

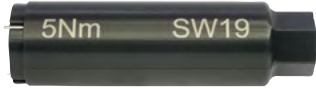
Description	Components of the set
Set SC02-AC10 	<ul style="list-style-type: none"> • Special wrench • Service manual

DTS 1000079488 EN Version: Y Status: RL (released | freigegeben | validé) printed: 02.02.2021

8. Ordering information

8.1. Bürkert eShop – Easy ordering and quick delivery



Bürkert eShop – Easy ordering and fast delivery

You want to find your desired Bürkert product or spare part quickly and order directly? Our online shop is available for you 24/7. Sign up and enjoy all the benefits.

[Order online now](#)

8.2. Bürkert product filter



Bürkert product filter – Get quickly to the right product

You want to select products comfortably based on your technical requirements? Use the Bürkert product filter and find suitable articles for your application quickly and easily.

[Try out our product filter](#)

8.3. Ordering chart

Standard version

Note:

- All devices with connection thread G 1/4, manual override and cable plug **Type 2518** ▶.
- Further versions on request
- Products with reduced delivery time

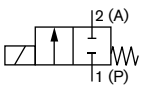
Circuit function	Orifice [mm]	Seal material	Housing or seat material	Article no. per voltage/frequency [V/Hz]		
				024/DC	024/50	230/50
A¹⁾, solenoid valve 2/2 way Direct-acting Normally closed 	3.0	FKM	Brass	020293	022883	124909
	3.0	FKM	Stainless steel	020292	023984	024563
	3.0	FKM	PP	018410	088496	045653
	3.0	FKM	PVDF	018188	020286	069006
	3.0	NBR	Brass	020294	086553	024902
	3.0	EPDM	PP	067214	022105	062398
	4.0	FKM	Brass	024019	025246	124912
	4.0	FKM	Stainless steel	018276	018857	020873
	4.0	FKM	PP	062695	043005	063116
	4.0	FKM	PVDF	023472	069079	087837
	4.0	NBR	Brass	025084	–	046007
	4.0	EPDM	PP	021660	067731	063118
	4.0	EPDM	PVDF	057573	–	125507
	5.0	FKM	PP	062624	067007	022619
	5.0	FKM	PVDF	064512	–	063786
	5.0	EPDM	PP	061321	054261	049969
5.0	EPDM	PVDF	120184	059802	130117	

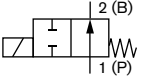
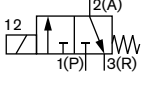
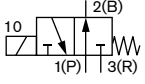
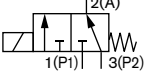
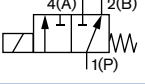
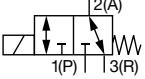
Circuit function	Orifice [mm]	Seal material	Housing or seat material	Article no. per voltage/frequency [V/Hz]		
				024/DC	024/50	230/50
B^{1.)}, solenoid valve 2/2 way Direct-acting Normally opened 	3.0	FKM	Brass	141917	130146	141919
	4.0	FKM	Brass	141920	141921	141923
	3.0	FKM	Stainless steel	141928	141929	141931
	4.0	FKM	Stainless steel	141932	141933	141935
C, solenoid valve 3/2 way Direct-acting Normally closed 	2.0	NBR	Brass	041103	042129	041105
	3.0	NBR	Brass	041107	041108	041116
	3.0	FKM	Stainless steel	052344	045024	052059
	4.0	NBR	Brass	042218	042695	042329
	4.0	FKM	Stainless steel	050483	043324	050979
	4.0	FKM	PP	–	088420	–
	4.0	FKM	PVDF	055788	–	019078
	4.0	EPDM	PP	–	–	063625
D, solenoid valve 3/2 way Direct-acting Normally opened 	2.0	NBR	Brass	056984	041858	041137
	3.0	NBR	Brass	041139	041141	041147
	4.0	NBR	Brass	043129	042696	042903
E, mixing valve (solenoid valve) 3/2 way 	3.0	FKM	PP	069917	066230	022294
	3.0	EPDM	PP	078556	–	078559
	4.0	FKM	PP	061077	086921	053406
	4.0	FKM	PVDF	022340	020550	085599
	4.0	EPDM	PP	067160	044693	066033
F, distribution valve (solenoid valve) 3/2 way Direct-acting 	4.0	FKM	PP	020528	–	–
	4.0	EPDM	PP	–	–	066032
T, solenoid valve 3/2 way Direct-acting Flow direction optional 	2.0	FKM	Brass	124922	138316	124925
	3.0	FKM	Brass	124927	124928	124930
	2.0	FKM	Stainless steel	124932	124933	124935
	3.0	FKM	Stainless steel	124937	124938	124940

1.) The listed article no. and circuit functions have a housing with straight pass.

Explosion proof version

Note:

- All devices with connection thread G ¼ and manual override
- Further versions on request

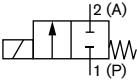
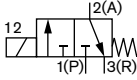
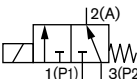
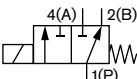
Circuit function	Orifice	Seal material	Housing or seat material	Electrical connection	Article no. per voltage/frequency [V/Hz]	
	[mm]				024/UC	230/UC
A¹⁾, solenoid valve 2/2 way Direct-acting Normally closed 	3.0	NBR	Brass	Terminal box	353707	353708
	3.0	NBR	Brass	Cable	353616	353617
	3.0	FKM	Stainless steel	Terminal box	353709	353710
	3.0	FKM	Stainless steel	Cable	353618	353619
C, solenoid valve 3/2 way Direct-acting Normally closed 	3.0	NBR	Brass	Terminal box	353594	353695
	3.0	NBR	Brass	Cable	353596	353599
	3.0	FKM	Stainless steel	Terminal box	353700	353706
	3.0	FKM	Stainless steel	Cable	353614	353615
E, mixing valve (solenoid valve) 3/2 way 	3.0	FKM	Stainless steel	Terminal box	353712	353702
	3.0	FKM	Stainless steel	Cable	353620	353621
F, distribution valve (solenoid valve) 3/2 way Direct-acting 	3.0	FKM	Stainless steel	Terminal box	394337	353713
	3.0	FKM	Stainless steel	Cable	353622	353623
	4.0	FKM	Stainless steel	Terminal box	353697	–
	4.0	FKM	Stainless steel	Cable	353646	–

1.) The listed article no. and circuit functions have a housing with straight pass.

8.4. Ordering chart accessories

Cable plug Type 2518, Form A according to DIN EN 175301 - 803

Note:

Further versions see data sheet [Type 2518](#) ▶.

Cable plug	Dimensions	Version	Voltage	Article no.
		Without circuitry (AC/DC)	0...250 V AC/DC	314802
		With LED (AC/DC)	12...24 V AC/DC	314812
		With LED and varistor (AC/DC)	12...24 V AC/DC	314820
		With rectifier, LED and varistor	12...24 V AC/DC	314816

Cable glands for ATEX/IECEx terminal box

Note:

- A cable gland in polyamide version is included in the delivery. A nickel-plated brass version can be ordered at surcharge.
- For more information on Ex cable glands, see [“7.3. Cable glands for ATEX/IECEx terminal box”](#) on page 13.

Description	Article no.
Ex cable gland, brass, nickel-plated, 6...13 mm ^{1.)}	773278
Ex cable gland, polyamide, 7...13 mm ^{1.)}	773277
Set SC02-AC10: Special wrench ^{2.)} incl. service manual	293488

1.) Cable diameter

2.) Not included in the scope of delivery of the valve

Mounting plate cpl. for DIN rail mounting

Description	Article no.
	013253

Locking ring

Description	Article no.
	013372

Bürkert – Close to You

For up-to-date addresses
please visit us at
www.burkert.com

DTS 1000079488 EN Version: Y Status: RL (released | freigegeben | validé) printed: 02.02.2021

