

M12 male 0° with cable

PUR 5x0.34 gy UL/CSA 13m

M12

Male straight

5-pole

Art.-No. 7005 - M12 Lite - (plastic hexagonal screw) on request

Plastic housings with good resistance against chemicals and oils. The resistance to aggressive media should be individually tested for your application. Further details on request. Further cable lengths on request.

[Link to Product](#)**Illustration**

(* for cable type 126 and 732)

Male

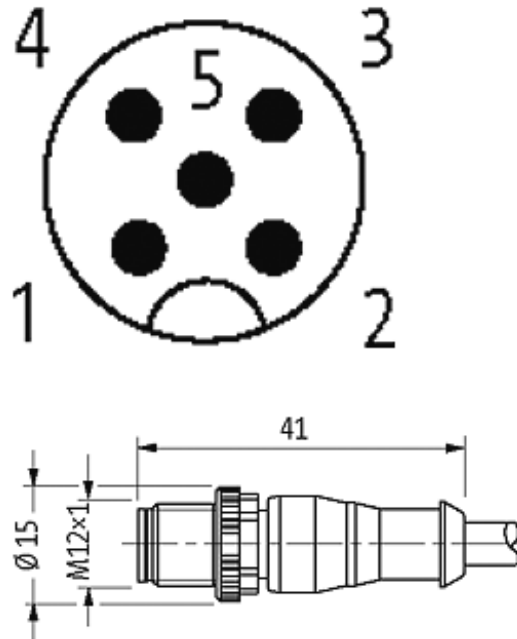

Product may differ from Image

Approvals



* only for products with UL/CSA approved cable

Form

12041

Technical Data

Operating voltage	max. 125 V AC/DC
Operating current per contact	max. 4 A
Locking of ports	Screw thread M12 × 1 mm (recommended torque 0.6 Nm) self-securing
Protection	IP67 inserted and tightened (EN 60529)

Cables

Cable number	225
No./diameter of wires	5 × 0.34 mm ²
Wire isolation	PVC (br, wh, bl, bk, gnye)
C-track properties	2 Mio.
Jacket Color	gray

Shore hardness outer jacket	85 ± 5A
Material (jacket)	PUR/PVC (UL/CSA)
Outer diameter	approx. 5.9 mm
Bend radius (fixed)	10 × outer Ø
Bend radius (moving)	15 × outer Ø
Temperature range (fixed)	-30...+80 °C
Temperature range (mobile)	-5...+80 °C

Commercial data

country of origin	DE
customs tariff number	85444290
minimum order quantity	1