

LUMAWISE ENDURANCE S CONNECTOR SYSTEM

TE Connectivity (TE) LUMAWISE Endurance S connector system is a complete set of products specially designed for street lighting control, compliant with Zhaga Book 18. This consists of a receptacle connector placed on a streetlight and several base and dome combinations to house sense and control modules from the surrounding harsh environments. The IP66 rated receptacle assembly, base and dome combinations provide a sealed electrical interface between new slim design LED streetlights and the associated sensor modules.

The LUMAWISE Endurance S base and dome form the module that is IK09 impact resistance rated which provides a robust packaging solution. This compact design is UV resistant, appealing to the eye and can be mounted facing upward, downwards or sideways bringing flexibility to the street light designer.

Applications

- Street and Area Lighting
- Sensor Ready Control Applications
- Outdoor Luminaires
 - Wall Packs
 - Parking Lots
 - Walkways
- Photo Controls
- Central Management System
- City Management System
- Other sensor modules e.g. occupancy

Electrical

- Contacts rating: 1.5A, 30V (24V typical)
- Meets 10kV dielectric withstand voltage to mounting surface
- 4 pole contacts
 - Pin 1: 24Vdc
 - Pin 2: DALI (or DALI based protocol) -/common ground
 - Pin 3: DALI (or DALI based protocol) +
 - Pin 4: General I/O

Mechanical

- Mounting: M20X1.5 thread
- Height above luminaire: 10mm
- IP65 & IP66
- Receptacle: Ø30mm
- Gasket: Ø36.5mm
- Thread length: 18.5mm
- IK09 rated system solution



Benefits

- Follows industry standard Zhaga Book 18
- Extend product life in harsh environments with an IP65 and IP66 rated product
- IK09 high impact resistant
- Flexibility in design with upwards, downwards and sideways facing mounting versatility
- Secure low torque mating of sealing cap or base and receptacle
- Condensation minimized with an optional vent feature



Materials





- PBT receptacle
- LSR gasket
- Polycarbonate domes
- UL UV-f1 rated for outdoor use

Specifications

- Application Specification: [114-133074](#)
- Product Specification: [108-133073](#)
- Rated IEC61984 and UL773
- CB Certified

Product Selection Information

		Part Number	Description	Color	Height
RECEPTACLE - SEALING CAP		2213858-1	Receptacle (includes sealing ring, washer and nut)	-	-
		2213795-1 2213795-2	Sealing Cap	Dark Gray Light Gray	-

		Part Number	Description	Color	Height
40mm BASE - DOMES		2213837-1	Base	-	-
		2329013-1	Dome	Smoke Gray	Low (24.25 mm)
		1-2329013-1	Dome	Clear	Low (24.25 mm)
		2329013-2	Dome	Smoke Gray	Tall (39.25 mm)
		1-2329013-2	Dome	Clear	Tall (39.25 mm)



[2329013-2](#)
LUMAWISE Endurance S Dome
Smoke Gray - Tall - 40mm



[2213837-1](#)
LUMAWISE Endurance S Base
40mm



[2213858-1](#)
LUMAWISE Endurance S
Receptacle

Receptacle

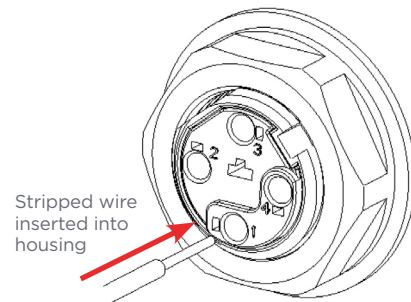

Stripped wire inserted into housing

Wire poke-in locations (4)

Pin #	Function
1	+24V power supply
2	Negative pole for Dali or Dali based protocol & shared ground return for 24V power supply
3	Positive pole for Dali or Dali based protocol
4	General digital I/O (greater than 7V)

LUMAWISE Endurance S products represented on this page are not shown actual size.

Colored wire insertion markings and additional keying solutions are also available, contact [Product and Customer Support](#).

Product Selection Information

	Part Number	Description	Color	Height
80mm BASES - DOMES	 2213831-3	Base	-	-
	 2213831-2	Base with Vent	-	-
	 2328823-1	Dome	Smoke Gray	Low (33.43 mm)
	 1-2328823-1	Dome	Clear	Low (33.43 mm)
	 2328823-2	Dome	Smoke Gray	Medium (43.43 mm)
	 1-2328823-2	Dome	Clear	Medium (43.43 mm)
	 2328823-3	Dome	Smoke Gray	Tall (58.43 mm)
	 1-2328823-3	Dome	Clear	Tall (58.43 mm)
OPTIONAL ACCESSORIES	 1-2337216-1	Skirt	Black	-
	 1-2337216-2	Skirt	Light Gray	-
	 1-2337216-3	Skirt	Dark Gray	-

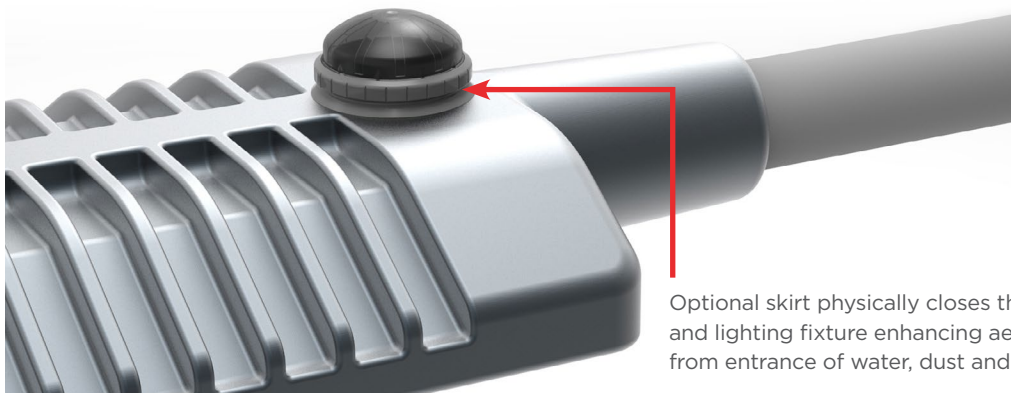

Optional skirt physically closes the gap between control module and lighting fixture enhancing aesthetics and further protecting from entrance of water, dust and insects.

[2213831-2](#)

LUMAWISE Endurance S Base with Vent
80mm

Flat surface for label placement.

An optional vent in the 80mm base assembly enables pressure optimization inside the sealed control module. The vent also helps to minimize condensation through vapor diffusion.

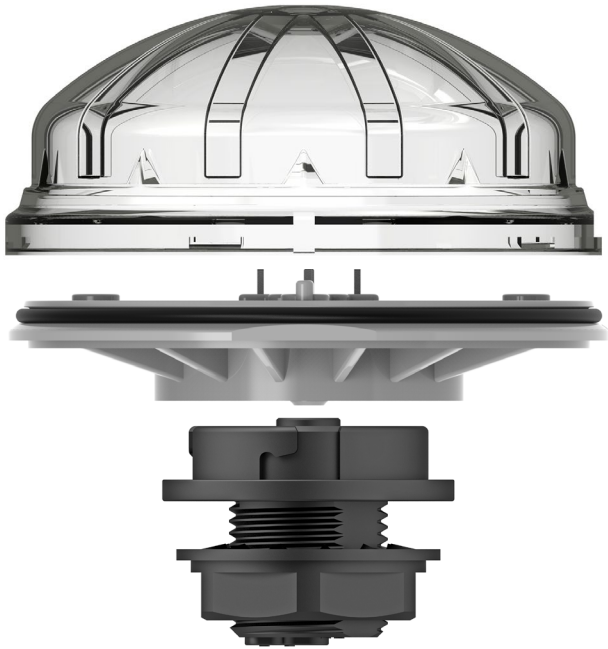
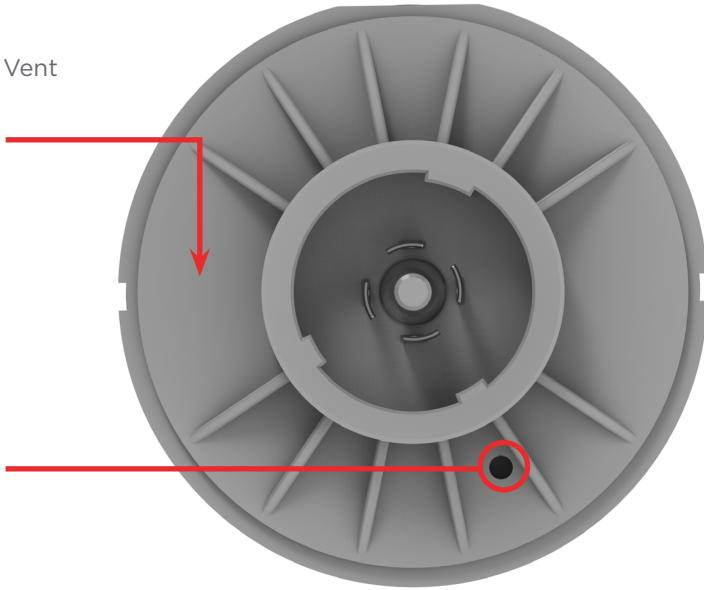

[1-2328823-1](#)

LUMAWISE Endurance S Dome
Clear - Low - 80mm

[2213831-3](#)

LUMAWISE Endurance S Base
80mm

[2213858-1](#)

LUMAWISE Endurance S Receptacle

LUMAWISE Endurance S products represented on this page are shown actual size.



TE Connectivity is a participating member of the Zhaga Consortium, an industry-wide cooperation enabling the interchangeability of LED light sources and simplifying LED applications for general lighting.

te.com

© 2019 TE Connectivity. All Rights Reserved. LUMAWISE, TE, TE Connectivity, and the TE connectivity (logo) are trademarks of the TE Connectivity. Other logos, product and company names mentioned herein may be trademarks of their respective owners.

While TE has made every reasonable effort to ensure the accuracy of the information in this brochure, TE does not guarantee that it is error-free, nor does TE make any other representation, warranty or guarantee that the information is accurate, correct, reliable or current. TE reserves the right to make any adjustments to the information contained herein at any time without notice. TE expressly disclaims all implied warranties regarding the information contained herein, including, but not limited to, any implied warranties of merchantability or fitness for a particular purpose. The dimensions in this catalog are for reference purposes only and are subject to change without notice. Specifications are subject to change without notice. Consult TE for the latest dimensions and design specifications.

1-1773915-3 JN 02/2019

USA: +1 (800) 522-6752
Canada: +1 (905) 475-6222
Mexico: +52 (0) 55-1106-0800
Latin/S. America: +54 (0) 11-4733-2200
Germany: +49 (0) 6251-133-1999
UK: +44 (0) 800-267666
France: +33 (0) 1-3420-8686
The Netherlands: +31 (0) 73-6246-999
China: +86 (0) 400-820-6015

