



### Model Number

**V1S-W-5M-PUR**

Cable connector, M12, 4-pin, PUR cable

### Features

- Knurled nut suitable for tool assembly
- Immunity to vibration, with mechanical latching
- Gold-plated and machined contacts
- Protection degree IP67 / IP68 / IP69K
- Halogen-free

### Dimensions

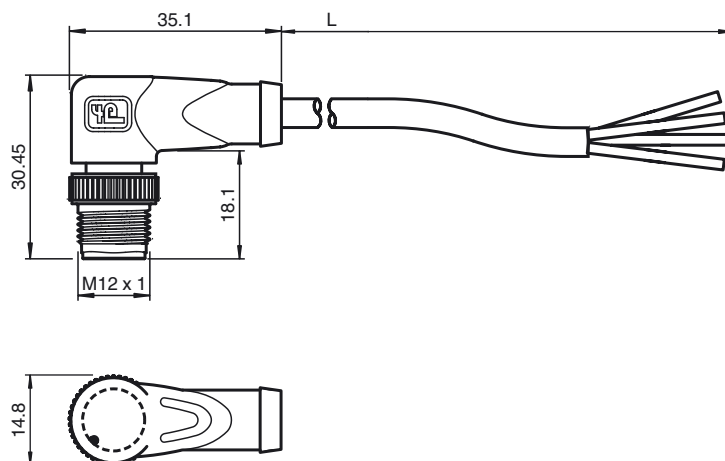

### Technical data

#### General specifications

Number of pins	4
Connection 1	Male connector
Construction type 1	right angle
Threading 1	M12
Connection 2	cable end

#### Electrical specifications

Operating voltage	$U_B$	max. 250 V AC/DC
Operating current		max. 4 A
Contact resistance		< 10 mΩ

#### Ambient conditions

Ambient temperature	Body: -40 ... 90 °C (-40 ... 194 °F) cable, fixed: -40 ... 80 °C (-40 ... 176 °F) cable, flexing: -25 ... 80 °C (-13 ... 176 °F)
Pollution Degree	3

#### Mechanical specifications

Pin diameter	1 mm
Protection degree	IP67 / IP68 / IP69k
Material	
Contacts	CuSn / Au
Contact surface	Au
Body	TPU, black
Cable	PUR
Sleeve connector	Diecast zinc
Core insulation	PP
Cable	fine-strand, flexible
Sheath diameter	Ø 4.8 mm
Bending radius	> 10 x cable diameter, moving > 8 x cable diameter, fixed
Color	grey
Cores	4 x 0.34 mm <sup>2</sup>
Conductor construction	19 x 0.15 mm Ø
Length	L 5 m
Flammability	
Contact material	94 HB
Housing	94 V-2

#### Compliance with standards and directives

Standard conformity	
Protection degree	EN 60529:2000
Standards	IEC 61076-2-101:2008

### Electrical connection

