



## GN SERIES | AC OUTPUT

PANEL MOUNT SOLID STATE RELAYS



### Features

- Current ratings from 10 to 125 Amps
- Output voltage 24-280 VAC and 48-660 VAC
- Available with or without IP20 touch-safe cover
- LED Input Status Indicator
- UL, CSA and TUV Approved, CE Compliant to EN60950-1
- Improved SEMS screw and washer
- Redesigned housing with anti-rotation barriers
- EMC Compliant to level 3

### PRODUCT SELECTION

Control Voltage	10 A	25 A	50 A	75 A	100 A	125 A
<b>3-32 VDC</b>	84134000	84134010	84134020	84134030	84134040	84134080
<b>18-36 VAC</b>	84134002	84134012	84134022	84134032	84134042	84134082
<b>90-280 VAC</b>	84134001	84134011	84134021	84134031	84134041	84134081

### SPECIFICATIONS

Output <sup>(1)</sup>

Description	280 VAC	660 VAC
<b>Operating Voltage (47-440 Hz) [Vrms]</b>	24-280	48-600
<b>Transient Voltage [Vpk] <sup>(2)</sup></b>	600	1200
<b>Maximum Off-State Leakage Current @ Rated Voltage [mArms]</b>	0.1	0.25
<b>Minimum Off-State dv/dt @ Maximum Rated Voltage [V/μsec]</b>	500	500

## Output <sup>(1)</sup>

Description	10 A	25 A	50 A	75 A	100 A	125 A
Maximum Load Current [Arms] <sup>(3)</sup>	10	25	50	75	100	125
Minimum Load Current [mArms]	50	50	100	100	100	100
Maximum 1 Cycle Surge Current (50/60 Hz) [Apk]	150/175	275/300	710/750	1050/1100	1120/1200	1600/1700
1 Second surge current (Apk. Ta=25°C) 50/60 Hz	50	85	150	225	300	375
Maximum On-State Voltage Drop @ Rated Current [Vpk]	1.35	1.35	1.35	1.3	1.3	1.25
Thermal Resistance Junction to Case (Rjc) [°C/W]	0.4	0.4	0.25	0.16	0.16	0.11
Maximum 1/2 Cycle I <sup>2</sup> t for Fusing (50/60Hz) [A <sup>2</sup> sec]	110/120	380/370	2520/2320	5500/5000	6270/6000	12800/12050
Minimum Heat Sink for Rated Current @ 40°C [°C/W]	5	2	1	0.7	0.5	0.5

## Input <sup>(1)</sup>

Description	8413xxx0	8413xxx2	8413xxx1
Control Voltage Range	3-32 VDC <sup>(4)</sup>	18-36 VAC	90-280 VAC <sup>(5)</sup>
Maximum Reverse Voltage	-32 VDC	-	-
Minimum Turn-On Voltage	3 VDC <sup>(4)</sup>	18 VAC	90 VAC
Must Turn-Off Voltage	1 VDC	4 VAC	10 VAC
Minimum Input Current (for on-state) [mA]	10	13	6
Maximum Input Current [mA]	15	15	10
Nominal Input Impedance [Ohm]	Current Regulated		
Maximum Turn-On Time [µsec]	1/2 Cycle <sup>(6)</sup>	20	20
Maximum Turn-Off Time [µsec]	1/2 Cycle	30	30

## General <sup>(1)</sup>

Description	Parameters
Dielectric Strength, Input/Output/Base (50/60 Hz)	4000 Vrms
Minimum Insulation Resistance (@ 500 VDC)	10 <sup>9</sup> Ohms
Maximum Capacitance, Input/Output	8 pF
Ambient Operating Temperature Range <sup>(7)</sup>	-40 to 80 °C
Ambient Storage Temperature Range	-40 to 125 °C
Weight (typical)	2.53 oz (72 g)
Housing Material	UL94 V-0
Baseplate Material	Aluminum
Input Terminal Screw Torque Range (lb-in/Nm)	13-15 / 1.5-1.7
Load Terminal Screw Torque Range (lb-in/Nm)	18-20 / 2-2.2
SSR Mounting Screw Torque Range (lb-in/Nm)	18-20 / 2-2.2
Humidity per IEC60068-2-78	93% non-condensing
LED Input Status Indicator	Green
MTBF (Mean Time Between Failures) at 40°C ambient temperature <sup>(8)</sup>	11,641,553 hours (1,328 years)
MTBF (Mean Time Between Failures) at 60°C ambient temperature <sup>(8)</sup>	7,210,376 hours (823 years)

## MECHANICAL SPECIFICATIONS (1)

Tolerance:  $\pm 0.02$  in / 0.5 mm

All dimensions are in: inches [millimeters]

### Screw Termination, IP00

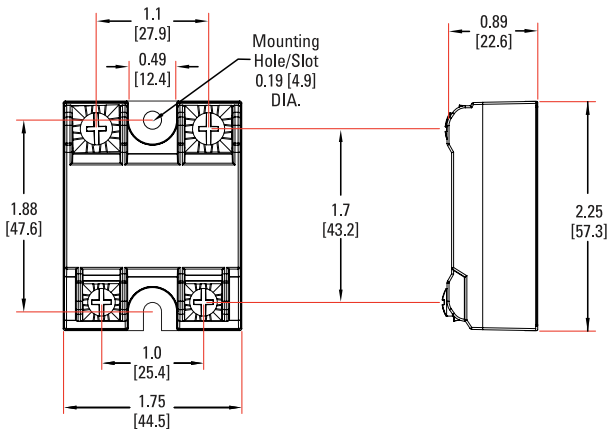

### Screw Termination, IP20

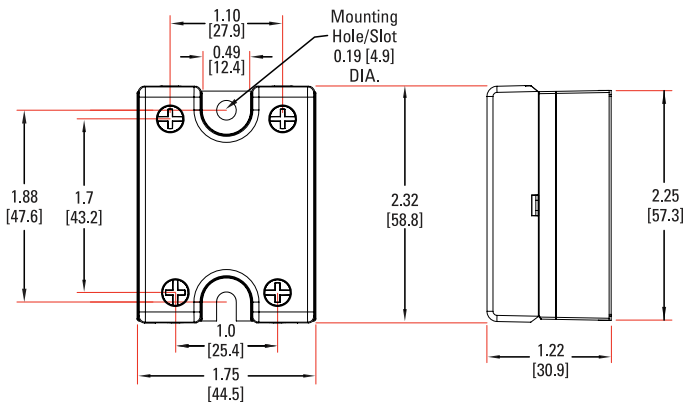

## EQUIVALENT CIRCUIT BLOCK DIAGRAMS

### GN Series DC Control

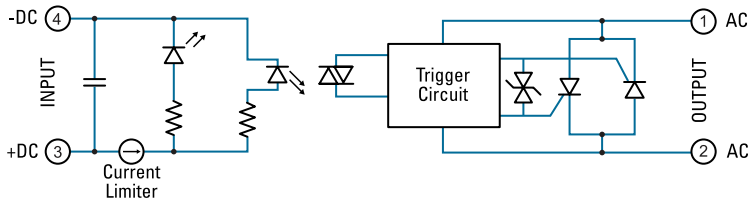

### Input Current vs Input Voltage Standard Regulated DC Input

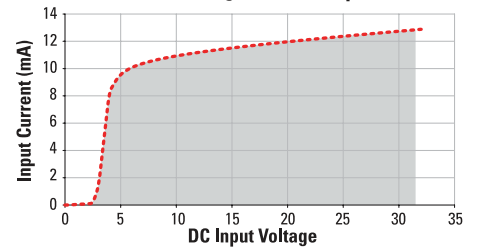

### GN Series AC Control

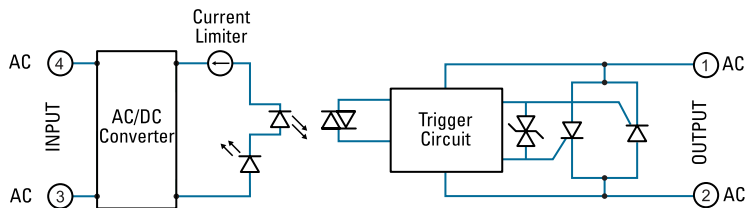

### Input Current vs Input Voltage Standard Regulated AC Input

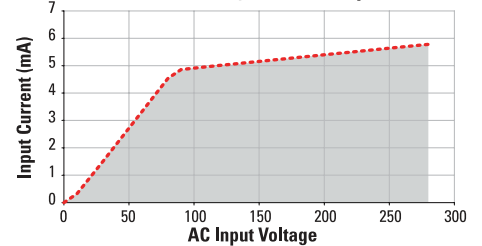

### Input Current vs Input Voltage Regulated AC Input Option E

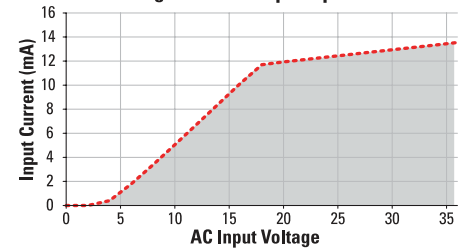

# WIRING DIAGRAM

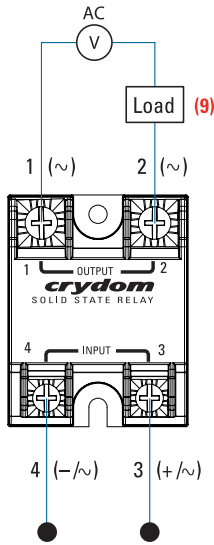

Recommended Wire Sizes		
Terminals	Wire Size (Solid / Stranded)	Wire Pull-Out Strength (lb)[N]
Input	24 AWG (0.2 mm <sup>2</sup> ) / 0.2 [minimum]	10 [44.5]
	2 x 12 AWG (3.3 mm <sup>2</sup> ) / 3.3 [maximum]	90 [400]
Output	20 AWG (0.5 mm <sup>2</sup> ) / 0.518 [minimum]	30 [133]
	2 x 10 AWG (5.3 mm <sup>2</sup> ) / 5.3	110 [490]
	2 x 8 AWG (8.4 mm <sup>2</sup> ) / 8.4 [maximum]	90 [400]

# SURGE CURRENT INFORMATION



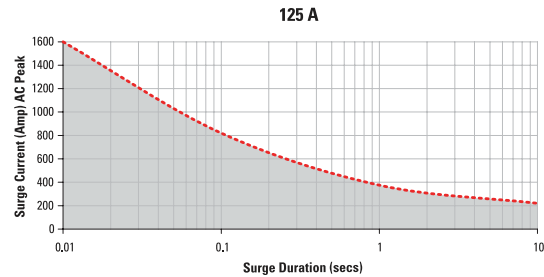
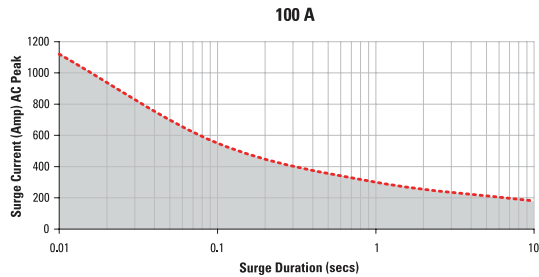
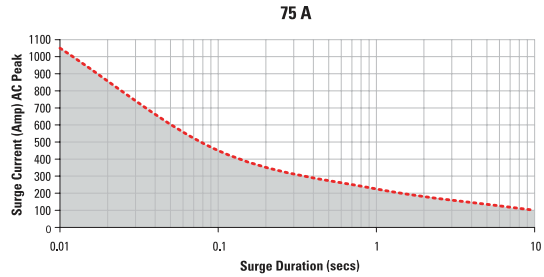
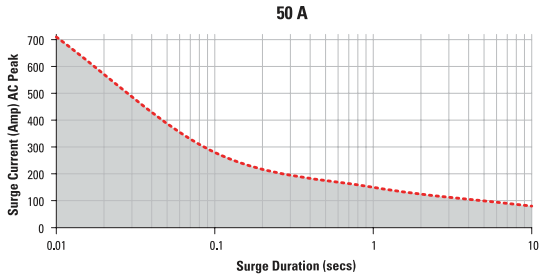
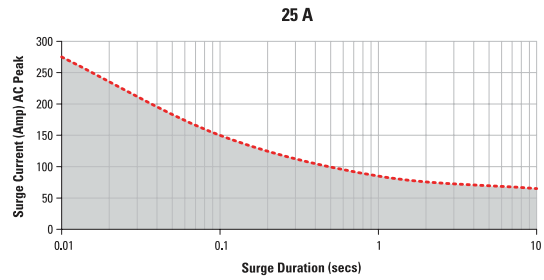
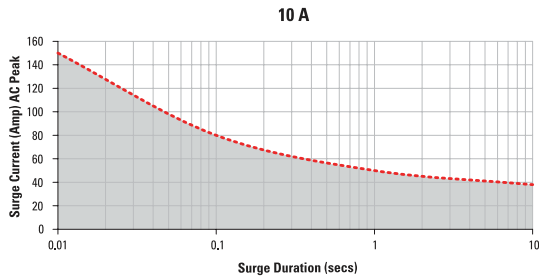

--- Single Pulse (10)

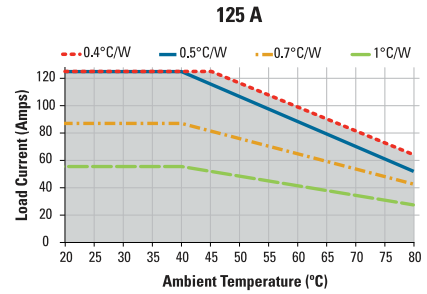
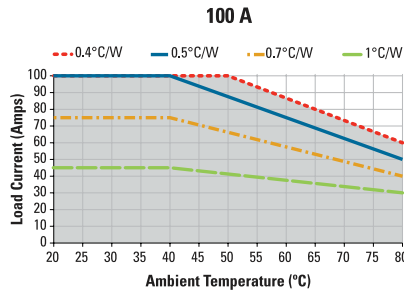
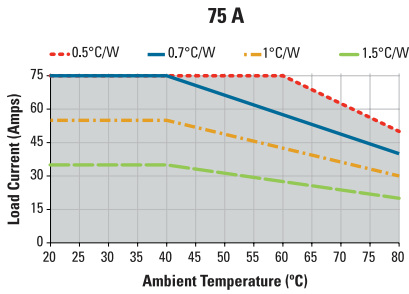
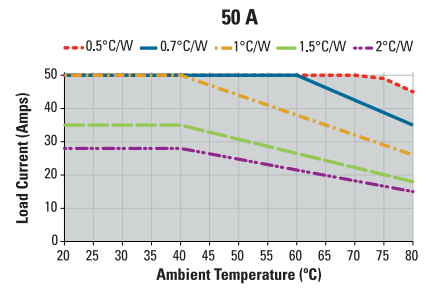
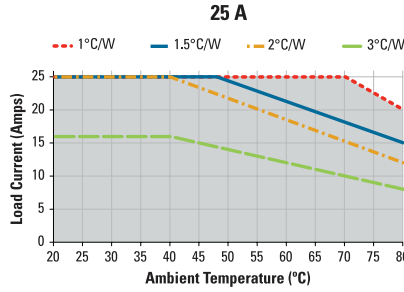
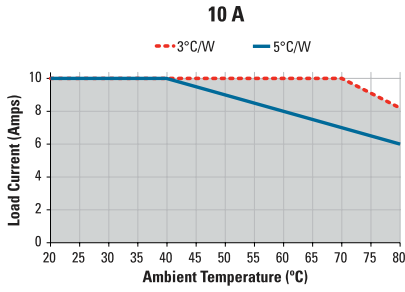

# THERMAL DERATE INFORMATION



# ACCESSORIES

Recommended Accessories					
					
Cover	Hardware Kit	Heat Sink Part No.	Thermal Resistance [°C/W]	Lug Terminal	Thermal Pad
KS101	HK1	HS501DR	5.0	TRM1	HSP-1
		HS301 / HS301DR	3.0	TRM6	HSP-2
	HS251	2.5			
	HS201 / HS201DR	2.0			
	HS202 / HS202DR	2.0			
	HS172	1.7			
	HS151 / HS151DR	1.5			
	HS122 / HS122DR	1.2			
	HS103 / HS103DR	1.0			
	HS101	1.0			
	HS073	0.7			
	HS072	0.7			
	HS053	0.5			
	HS033	0.36			
HS023	0.25				

## ORDERING OPTIONS

Example : 84134010H

	8413	4	0	1	0	H
<b>Series</b>						
8413						
<b>Touch Safe Cover</b>						
4 : Not included (IP00) 7 : Included (IP20)						
<b>Operating Voltage</b>						
0 : 24-280 VAC/Zero Voltage Turn-On 1 : 48-660 VAC/Zero Voltage Turn-On 2 : 24-280 VAC/Instantaneous Turn-On 3 : 48-660 VAC/Instantaneous Turn-On						
<b>Rated Load Current</b>						
0 : 10 Amps 1 : 25 Amps 2 : 50 Amps 3 : 75 Amps 4 : 100 Amps 8 : 125 Amps						
<b>Control Voltage</b>						
0 : 3-32 VDC 1 : 90-280 VAC 2 : 18-36 VAC						
<b>Thermal Pad</b>						
Blank : Not Included H : Included						

— Required for valid part number  
□ For options only and not required for valid part number

Not all part number combinations are available.  
Contact Technical Support for information on the availability of a specific part number.

## GENERAL NOTES

- (1) All parameters at 25°C unless otherwise specified.
- (2) Output will self trigger between 450-600 Vpk / 900-1200 Vpk for 280 VAC/660 VAC models not suitable for capacitive loads.
- (3) Heat sinking required, see derating curves.
- (4) 14-32 VDC for 48-660 VAC models.
- (5) For ambient temperatures above 40°C the maximum control voltage must not exceed 250 VAC.
- (6) Turn-on time for Instantaneous turn-on versions is 0.1 msec.
- (7) AC models operating range is -20 to 80°C.
- (8) All parameters at 50% power rating and 100% duty cycle (contact Crydom tech support for detailed report).
- (9) Load can be wired to either SSR output terminal 1 or 2.
- (10) For single surge pulse Tc=25°C; Tj=125°C. For AC Output SSRs, AC Rms value of surge current equals the peak value divided by  $\sqrt{2}$  (1.414).

For additional information or specific questions, contact Technical Support.

## AGENCY APPROVALS & CERTIFICATIONS



EN60950-1: Meets the requirements of sections 1.5: 1.7: 2.9: 2.10.5.3: 4.2: 4.5: 4.7:

Certified according to EN 62314:2006

IEC 61000-4-2 Electrostatic Discharge Level 3

IEC 61000-4-4 Electrically Fast Transients Level 3

IEC 61000-4-5 Electrical Surges Level 3

## WARNINGS



### RISK OF MATERIAL DAMAGE AND HOT ENCLOSURE

- The product's side panels may be hot, allow the product to cool before touching
- Follow proper mounting instructions including torque values
- Do not allow liquids or foreign objects to enter this product

**Failure to follow these instructions can result in serious injury, or equipment damage.**



### HAZARD OF ELECTRIC SHOCK, EXPLOSION OR ARC FLASH

- Disconnect all power before installing or working with this equipment
- Verify all connections and replace all covers before turning on power

**Failure to follow these instructions will result in death or serious injury.**

Datasheets provided by Sensata Technologies, Inc., its subsidiaries and/or affiliates ("Sensata") are solely intended to assist third parties ("Buyers") who are developing systems that incorporate Sensata products (also referred to herein as "components"). Buyer understands and agrees that Buyer remains responsible for using its independent analysis, valuation, and judgment in designing Buyer's systems and products. Sensata datasheets have been created using standard laboratory conditions and engineering practices. Sensata has not conducted any testing other than that specifically described in the published documentation for a particular datasheet. Sensata may make corrections, enhancements, improvements, and other changes to its datasheets or components without notice.

Buyers are authorized to use Sensata datasheets with the Sensata component(s) identified in each particular datasheet. HOWEVER, NO OTHER LICENSE, EXPRESS OR IMPLIED, BY ESTOPPEL OR OTHERWISE TO ANY OTHER SENSATA INTELLECTUAL PROPERTY RIGHT, AND NO LICENSE TO ANY THIRD PARTY TECHNOLOGY OR INTELLECTUAL PROPERTY RIGHT, IS GRANTED HEREIN. SENSATA DATASHEETS ARE PROVIDED "AS IS". SENSATA MAKES NO WARRANTIES OR REPRESENTATIONS WITH REGARD TO THE DATASHEETS OR USE OF THE DATASHEETS, EXPRESS, IMPLIED, OR STATUTORY, INCLUDING ACCURACY OR COMPLETENESS. SENSATA DISCLAIMS ANY WARRANTY OF TITLE AND ANY IMPLIED WARRANTIES OF MERCHANTABILITY, FITNESS FOR A PARTICULAR PURPOSE, QUIET ENJOYMENT, QUIET POSSESSION, AND NON-INFRINGEMENT OF ANY THIRD PARTY INTELLECTUAL PROPERTY RIGHTS WITH REGARD TO SENSATA DATASHEETS OR USE THEREOF.

All products are sold subject to Sensata's terms and conditions of sale supplied at [www.sensata.com](http://www.sensata.com). SENSATA ASSUMES NO LIABILITY FOR APPLICATIONS ASSISTANCE OR THE DESIGN OF BUYERS' PRODUCTS. BUYER ACKNOWLEDGES AND AGREES THAT IT IS SOLELY RESPONSIBLE FOR COMPLIANCE WITH ALL LEGAL, REGULATORY, AND SAFETY-RELATED REQUIREMENTS CONCERNING ITS PRODUCTS, AND ANY USE OF SENSATA COMPONENTS IN ITS APPLICATIONS, NOTWITHSTANDING ANY APPLICATIONS-RELATED INFORMATION OR SUPPORT THAT MAY BE PROVIDED BY SENSATA.

Mailing Address: Sensata Technologies, Inc., 529 Pleasant Street, Attleboro, MA 02703, USA

## CONTACT US

### Americas

+1 (877) 502 5500  
[sales.crydom@sensata.com](mailto:sales.crydom@sensata.com)

### Europe, Middle East & Africa

+44 (1202) 416170  
[ssr-info.eu@sensata.com](mailto:ssr-info.eu@sensata.com)

### Asia Pacific

[sales.isasia@list.sensata.com](mailto:sales.isasia@list.sensata.com)  
China +86 (21) 2306 1500  
Japan +81 (45) 277 7117  
Korea +82 (31) 601 2004  
India +91 (80) 67920890  
Rest of Asia +886 (2) 27602006  
ext 2808