



GDME 2013 schwarz/black

Industrial Connectors:Rectangular connectors GDM-series:Type AEN 175301-803 (DIN 43650) / ISO 4400:Cable socket with electronic insert

Product description

Description	cable socket with central screw M 3 x 40, strain relief and transparent cover, possibility to fit electronic inserts
Type	GDME 2013 schwarz/black
Order No.	933 030-100
Other standard types	grey housing, Order no. 933 030-106
Number of contacts	2 + PE
Cable gland	PG 13.5 (black)
Conductor size	max. 1.5 mm ²
Standard	DIN EN 175 301-803-A
Housing Color	black, with transparent cover
Construction type	A

Drawing

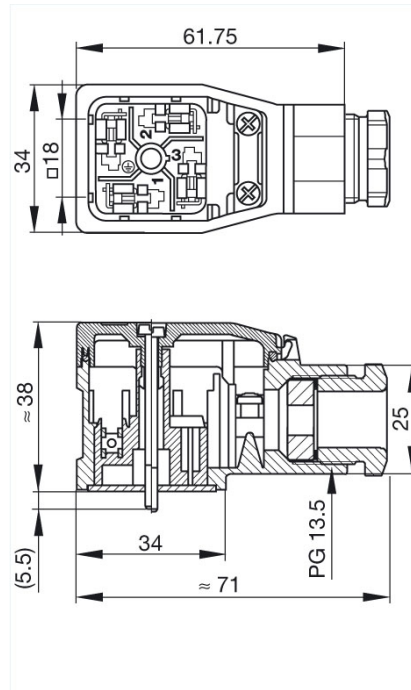

Technical data

Pin dimensions	6.3 mm x 0.8 mm, 4.8 mm x 0.8 mm
Rated voltage	AC 400 V, DC 250 V without inserts
Rated current	16 A
Contact resistance	≤ 4 mOhm

Type of termination	screw
Suitable cables	10 mm to 14 mm diameter
Mounting	central nut
Material	
Contact surface material	Sn
Contact bearer material	PA
Housing material	PA
Environmental conditions	
Protection class (IEC 60529)	IP 65 (gasket necessary)
Pollution severity	3
Temperature range	-40 °C to +85 °C
Inflammability class	
Housing	94 V1
Contact bearer	94 V1
Approvals	
VDE	VDE
SEV	SEV
GL	GL
Packing unit	
Packaging unit	50 pieces
Scope of delivery and accessories	
Accessories to order separately	(NBR) flat gasket GDM 3-7, Order no. 730 801-002; (EPDM) flat gasket GDM 3-21, Order no. 731 739-004; knurled screw GDME 3N-7, Order no. 732 280-001