



GSP 213 PG13,5 schwarz/black

Industrial Connectors:Rectangular connectors GDM-series:Type A EN 175301-803 (DIN 43650) / ISO 4400:Appliance connector

Product description

Description	appliance connector with thread, appliance connector, threaded sleeve, grip ring, o-ring (NBR)
Type	GSP 213 PG13,5 schwarz/black
Order No.	931 298-003
Number of contacts	2 + PE
Cable gland	PG 13.5
Standard	DIN EN 175 301-803-A
Housing Color	black
Construction type	A

Drawing

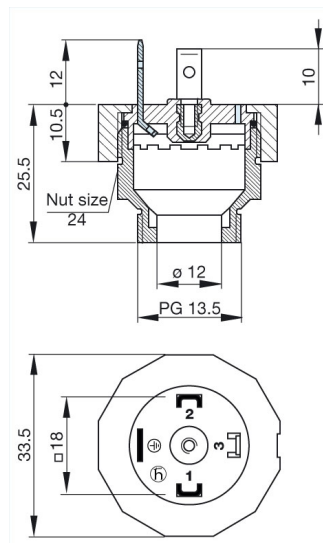

Technical data

Rated voltage	UC 400 V
Rated current	16 A
Contact resistance	≤ 4 mOhm
Type of termination	solder
Mounting	screw

Material

Contact surface material	Sn
Contact bearer material	PA
Housing material	PA

Environmental conditions

Protection class (IEC 60529)	IP 65 (gasket necessary) (mated)
Pollution severity	3
Temperature range	-40 °C to +125 °C

Inflammability class

Contact bearer	94 HB
----------------	-------

Approvals

VDE	VDE
SEV	SEV
Packing unit	
Packaging unit	200 pieces