

The supplier acknowledges that, with the acceptance of the drawings, the manufacturer is in a position to manufacture the illustrated part in accordance with the drawings in reproducible form and series production. Through the selected manufacturing processes or materials, which could subsequently lead to an impairment of the components. Verbal agreements over and above that are not valid. Deviations from this rule must be written and must be signed by the purchaser.

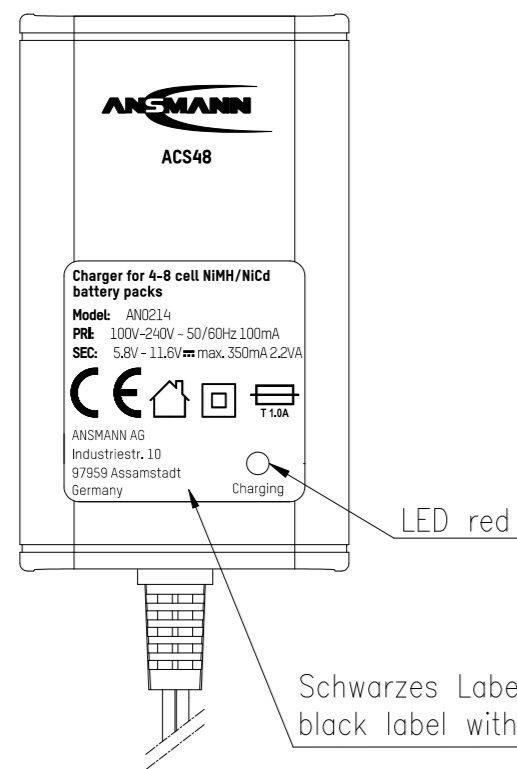

LED red

Schwarzes Label mit weißer Bedruckung/
black label with white printing

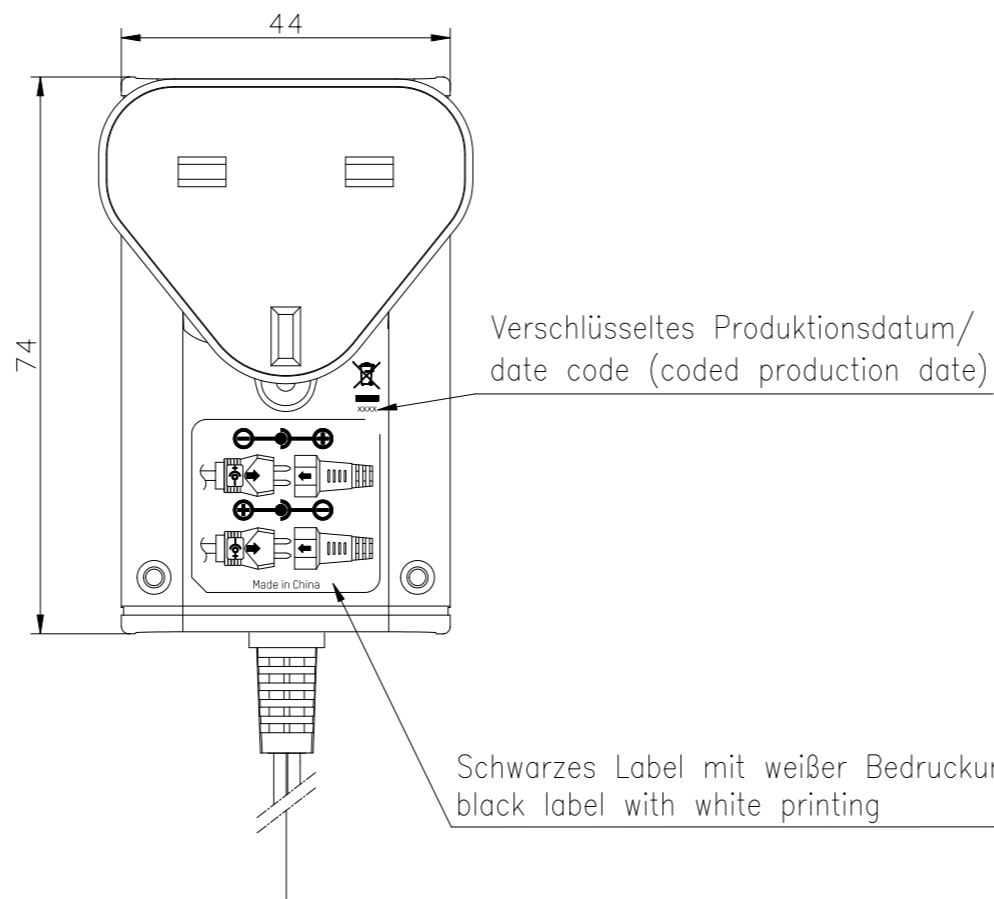

Schwarzes Label mit weißer Bedruckung/
black label with white printing

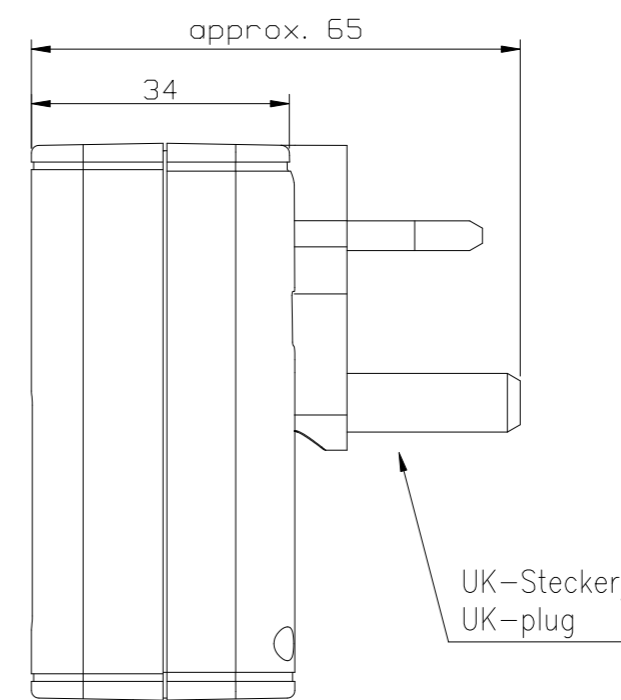

UK-Stecker/
UK-plug

inkl. Euro Stecker /
incl. Euro plug

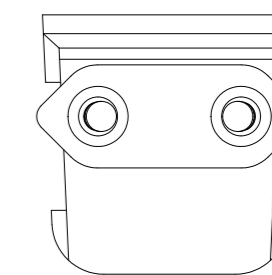

Rundleitung schwarz geschirmt 1,8m ±10cm lang/
roundcable black with shield 1.8m ±10cm long

Bindstreifen/
tape

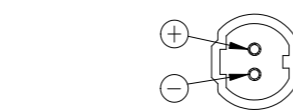

polarisierte Umpolkupplung/
polarized reversal socket

Technische Daten/ technical data	: Steckerladegerät/ plug-in charger
Chemie/ chemistry	: NiMH/NiCd
Zellenzahl/ no. of cells	: 4-8 Zellen/ cells
ladbare Kapazität/ loadable capacity	: min. 3500/1500mAh 4/8 cells max. ----mAh
Eingangsspannung/ input voltage	: 100-240VAC ±10% / 50/60Hz
Eingangsschutz/ primary electrical protection	: Sicherung T1A fuse
Leistungsaufnahme im Leerlauf/ stand-by power consumption	: < 0.5W
Nenn-Leistungsaufnahme/ nominal power consumption	: ca./ approx. 2.2W
Ableitstrom/ Leakage current	: < 100uA
Ausgangsspannung im Leerlauf/ no load output voltage	: ca./ approx. 15VDC
Nennausgangsspannung/ nominal output voltage	: 4.8...9.6VDC (4-8 Zellen/ cells)
Nennladestrom/ nominal charge current	: 350mA ±10% @ 4.8V 150mA ±10% @ 9.6V
Ausgangs-Schutz/ secondary electrical protection	: gegen Kurzschluß- und Falschpolung/ against short circuit and wrong polarity
Akku-Vollerkennung/ battery full detection	: ---
Sicherheitstimer/ safety timer	: ---
Spannungsfestigkeit/ electric strength	: 4 kV Eingang/Ausgang primary/secondary
Schutzklasse/ protection class	: II
Betriebstemperatur/ operating temperature	: 0°C...+40°C
Lagertemperatur/ storage temperature	: -25°C...+70°C

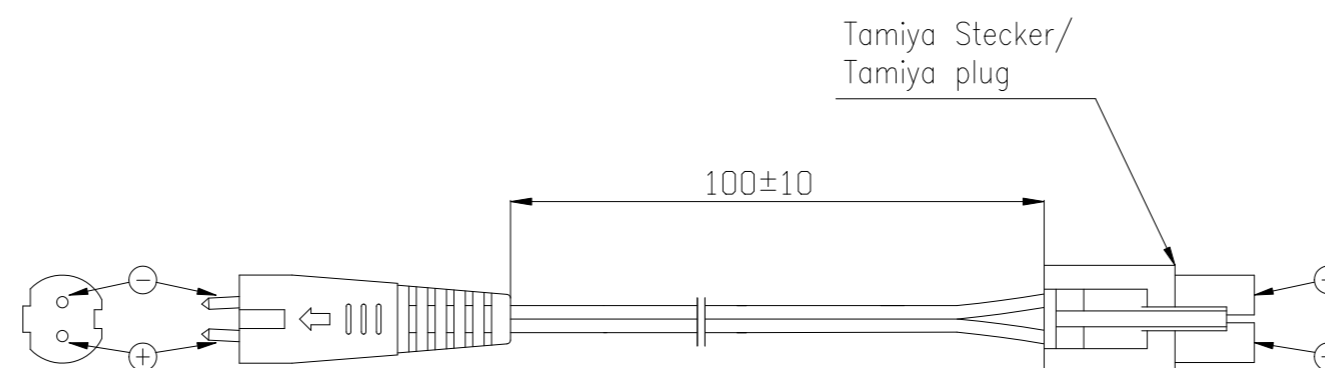

Tamiya Stecker/
Tamiya plug

Nettogewicht/ net weight	: xxxg
Gehäuse/ case	: Steckergehäuse, schwarz, Typ/ APS1000 plug-in housing, black, type
Gehäusematerial/ case material	: ABS plastic
Leiterplattenmaterial/ pcb material	: CEM1
Schutzart/ case protection	: IP 20
Typenschild Vorderseite/ ratingplate front	: ---
Typenschild Rückseite/ ratingplate back	: schwarzer Aufkleber mit weißer Bedruckung/ black label with white printing/
Anleitungen/ instructions	: ---
Approbationen/ approvals	: CE
Normen/ standards	: IEC/EN 60335-1, IEC/EN60335-2-29
Anzeigen/ indicators	: LED rot leuchtet beim Laden/ LED red lights during charge

Klinkenstecker/
jackplug
Ø2,5x13±0.5mm

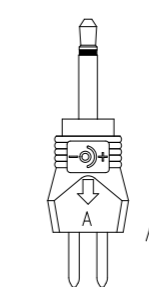

A

Klinkenstecker/
jackplug
Ø3,5x15mm

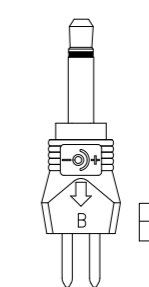

B

Hohlstecker/
hollowplug
Ø2,1xØ5x12mm

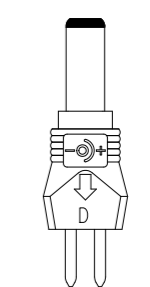

D

Hohlstecker/
hollowplug
Ø2,5xØ5,5x12mm

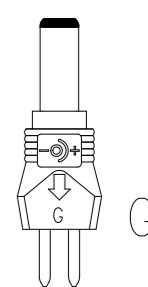

G

Hohlstecker/
hollowplug
Ø1,35xØ3,5x10mm

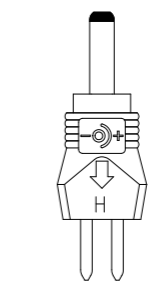

H

Hohlstecker/
hollowplug
Ø1,7xØ4x10mm

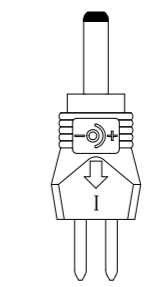

I

Hohlstecker/
hollowplug
Ø1,75xØ4,75x10mm

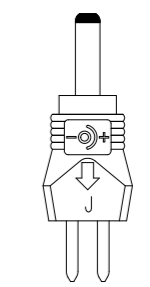

J

Hohlstecker/
hollowplug
Ø2,1xØ5,5x12mm

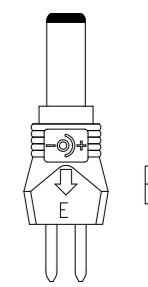

E

Verwendungsbereich/ Application range für Anfrage/for inquiry AN0214	Zul. Abweichung/ Allowable deviation	Oberfläche/ Surface	Maßstab/Scale (DIN A2): 1:1	Gewicht/Weight
	Allgemeintoleranz DIN ISO 2768-m		Werkstoff/Work material, Modell-Nr. XXXXXXXXXXXXXXXXXXXXXXXXXX	
	2014	Datum/Date Name	Zeichnungsname/Drawing name	
	Erstellt/ Drawn by	27.05.14 CB	ACS48	
	ANSMANN		Zeichnungsnummer/Drawing number Artikelnummer/Part number	Blatt/ Sheet
VO ---	12.06.18 SIT	Ursprung/Origin Proj. IS-2013-00227	1001-0024-UK	1
Version	Änderung/Change	Datum/Date Name	Ersatz für/Replaced by	Ersatz durch/Replacement through: