



**Circuit-breaker, 3p, 160A + RCD 30mA, type B, AC/DC sensitive**

**Part no. NZMH2-A160-FIA30-500AC**  
**Article no. 184961**

**Delivery programme**



Product range			Circuit-breaker
Protective function			System and cable protection, fire protection, personnel protection
Standard/Approval			IEC
Installation type			Fixed
Release system			Thermomagnetic release, AC/DC sensitive earth-fault release
Construction size			NZM2
Description			For equipment with power electronics, such as inverters and variable frequency drives Ready-to-connect combination consisting of type B circuit-breaker and residual current circuit-breaker and type A passive section Suitability for the application in three-phase systems without neutral conductor Personnel protection and preventive fire protection for 0 - 100 kHz fault current frequency Operational voltage range Type B 50 - 500 V AC (+ 10 %) Type A functionality even without operational voltage for rated frequency of 50/60 Hz Not UL/CSA approved Adjusting buttons can be sealed. Rated operating voltage 500 V AC (+/- 10 %) Rated frequency 50/60 Hz Rated fault current $I_{\Delta n} = 0.03 \text{ A}$
Number of poles			3 pole
Standard equipment			Screw connection
Rated operational voltage	U <sub>e</sub>	V AC	500
<b>Switching capacity</b>			
400/415 V 50 Hz	I <sub>cu</sub>	kA	150
<b>Rated current = rated uninterrupted current</b>			
Rated current = rated uninterrupted current	I <sub>n</sub> = I <sub>u</sub>	A	160
<b>Setting range</b>			
Overload trip			
	I <sub>r</sub>	A	125 - 160
Short-circuit releases			
Non-delayed	I <sub>i</sub> = I <sub>n</sub> x ...		6 - 10
Short-circuit releases	I <sub>rm</sub>	A	960 - 1600

**Technical data**

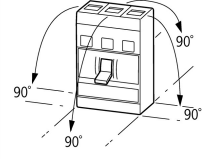
<b>General</b>			
Standards			IEC/EN 60947, VDE 0660, EN 62423: Type B
Protection against direct contact			Finger and back of hand proof to VDE 0106 Part 100
Climatic proofing			Damp heat, constant, to IEC 60068-2-78 Damp heat, cyclic, to IEC 60068-2-30
Ambient temperature			
Ambient temperature, storage		°C	- 40 - + 70

Operation	°C	-25 - +70
Mechanical shock resistance (10 ms half-sinusoidal shock) according to IEC 60068-2-27	g	20 (half-sinusoidal shock 20 ms)
Safe isolation to EN 61140		
Between auxiliary contacts and main contacts	V AC	500
between the auxiliary contacts	V AC	300
Weight	kg	2.345
Mounting position		<p>Vertical and 90° in all directions</p>  <p>With residual-current release XFI:  - NZM1, N1, NZM2, N2: vertical and 90° in all directions  with plug-in adapter elements  - NZM1, N1, NZM2, N2: vertical, 90° right/left  with withdrawable unit:  - NZM3, N3: vertical, 90° left  - NZM4, N4: vertical  with remote operator:  - NZM2, N(S)2, NZM3, N(S)3, NZM4, N(S)4: vertical and 90° in all directions</p>
Direction of incoming supply		bottom
Degree of protection		
Device		In the operating controls area: IP20 (basic degree of protection)
Enclosures		With insulating surround: IP40 With door coupling rotary handle: IP66
Terminations		Tunnel terminal: IP10 Phase isolator and strip terminal: IP00
Other technical data (sheet catalogue)		Weight Temperature dependency, Derating Effective power loss

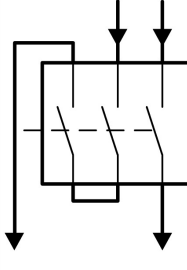
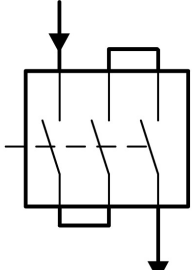
### Circuit-breakers

Rated current = rated uninterrupted current	$I_n = I_u$	A	160
Rated surge voltage invariability	$U_{imp}$		
Main contacts		V	8000
Auxiliary contacts		V	6000
Rated operational voltage	$U_e$	V AC	500
Rated operational voltage	$U_e$	V DC	750
			<p>Angabe gilt für 3-polige Anlagenschutzschalter mit thermomagnetischem Auslöser NZMN(H)1(2)(3)-A... bis 500 A.</p> <p>Für Bemessungsbetriebsspannung Schalten über 3 Strombahnen gilt:  Korrekturfaktor DC für Schnellauslöseransprechwert: NZM1: 1.25, NZM2: 1.35, NZM3: 1.45</p> <p>Einstellwert für <math>I_i</math> bei DC = Einstellwert <math>I_i</math> AC/Korrekturfaktor DC</p> <p><b>Verschaltungsart:</b>  <b>2-polig, + und -, zweiseitig</b></p>  <p><b>Verschaltungsart:</b>  <b>1-polig, + oder -, zweiseitig</b></p> 
Overvoltage category/pollution degree			III/3
Rated insulation voltage	$U_i$	V	1000
Use in unearthed supply systems		V	 500

### Switching capacity

Rated short-circuit making capacity	$I_{cm}$		
240 V	$I_{cm}$	kA	330
400/415 V	$I_{cm}$	kA	330

440 V 50/60 Hz	I <sub>cm</sub>	kA	286
525 V 50/60 Hz	I <sub>cm</sub>	kA	105
Rated short-circuit breaking capacity I <sub>cn</sub>	I <sub>cn</sub>		
I <sub>cu</sub> to IEC/EN 60947 test cycle O-t-CO	I <sub>cu</sub>	kA	
240 V 50/60 Hz	I <sub>cu</sub>	kA	150
400/415 V 50/60 Hz	I <sub>cu</sub>	kA	150
440 V 50/60 Hz	I <sub>cu</sub>	kA	130
525 V 50/60 Hz	I <sub>cu</sub>	kA	50
500 V DC	I <sub>cu</sub>	kA	60
750 V DC	I <sub>cu</sub>	kA	60
I <sub>cs</sub> to IEC/EN 60947 test cycle O-t-CO-t-CO	I <sub>cs</sub>	kA	
240 V 50/60 Hz	I <sub>cs</sub>	kA	150
400/415 V 50/60 Hz	I <sub>cs</sub>	kA	150
440 V 50/60 Hz	I <sub>cs</sub>	kA	130
525 V 50/60 Hz	I <sub>cs</sub>	kA	37.5
500 V DC	I <sub>cs</sub>	kA	15
750 V DC	I <sub>cs</sub>	kA	15
			Maximum back-up fuse, if the expected short-circuit currents at the installation location exceed the switching capacity of the circuit-breaker.
Rated short-time withstand current			
t = 0.3 s	I <sub>cw</sub>	kA	1.9
t = 1 s	I <sub>cw</sub>	kA	1.9
Utilization category to IEC/EN 60947-2			A
Rated making and breaking capacity			
Rated operational current	I <sub>e</sub>	A	
AC-1			
380 V 400 V	I <sub>e</sub>	A	160
415 V	I <sub>e</sub>	A	160
AC--3			
380 V 400 V	I <sub>e</sub>	A	160
415 V	I <sub>e</sub>	A	160
Lifespan, mechanical(of which max. 50 % trip by shunt/undervoltage release)	Operations		20000
Lifespan, electrical			
AC-1			
400 V 50/60 Hz	Operations		10000
415 V 50/60 Hz	Operations		10000
AC--3			
400 V 50/60 Hz	Operations		6500
415 V 50/60 Hz	Operations		6500
Max. operating frequency		Ops/h	120
Total downtime in a short-circuit		ms	< 10

### Terminal capacity

Standard equipment			Screw connection
Round copper conductor			
Box terminal			
Solid		mm <sup>2</sup>	1 x (10 - 16) 2 x (6-16)
Stranded		mm <sup>2</sup>	1 x (25 - 185) 2 x (25 - 70)
Tunnel terminal			
Solid		mm <sup>2</sup>	1 x 16
Stranded		mm <sup>2</sup>	
Stranded		mm <sup>2</sup>	1 x (25 - 185)
Bolt terminal and rear-side connection			

Direct on the switch			
Solid		mm <sup>2</sup>	1 x (10 - 16) 2 x (6 - 16)
Stranded		mm <sup>2</sup>	1 x (25 - 185) 2 x (25 - 70)
Al conductors, Cu cable			
Solid		mm <sup>2</sup>	1 x 16
Bolt terminal and rear-side connection			
Flat copper strip, with holes	min.	mm	2 x 16 x 0.8
Flat copper strip, with holes	max.	mm	10 x 24 x 0.8
Cu strip (number of segments x width x segment thickness)			
Box terminal			
	min.	mm	2 x 9 x 0.8
	max.	mm	10 x 16 x 0.8 (2x) 8 x 15.5 x 0,8
Bolt terminal and rear-side connection			
Flat copper strip, with holes	min.	mm	2 x 16 x 0.8
Flat copper strip, with holes	max.	mm	10 x 24 x 0.8
Copper busbar (width x thickness)		mm	
Bolt terminal and rear-side connection			
Screw connection			M8

## Design verification as per IEC/EN 61439

Technical data for design verification			
Rated operational current for specified heat dissipation	I <sub>n</sub>	A	160
Operating ambient temperature min.		°C	-25
Operating ambient temperature max.		°C	70
IEC/EN 61439 design verification			
10.2 Strength of materials and parts			
10.2.2 Corrosion resistance			Meets the product standard's requirements.
10.2.3.1 Verification of thermal stability of enclosures			Meets the product standard's requirements.
10.2.3.2 Verification of resistance of insulating materials to normal heat			Meets the product standard's requirements.
10.2.3.3 Verification of resistance of insulating materials to abnormal heat and fire due to internal electric effects			Meets the product standard's requirements.
10.2.4 Resistance to ultra-violet (UV) radiation			Meets the product standard's requirements.
10.2.5 Lifting			Does not apply, since the entire switchgear needs to be evaluated.
10.2.6 Mechanical impact			Does not apply, since the entire switchgear needs to be evaluated.
10.2.7 Inscriptions			Meets the product standard's requirements.
10.3 Degree of protection of ASSEMBLIES			Does not apply, since the entire switchgear needs to be evaluated.
10.4 Clearances and creepage distances			Meets the product standard's requirements.
10.5 Protection against electric shock			Does not apply, since the entire switchgear needs to be evaluated.
10.6 Incorporation of switching devices and components			Does not apply, since the entire switchgear needs to be evaluated.
10.7 Internal electrical circuits and connections			Is the panel builder's responsibility.
10.8 Connections for external conductors			Is the panel builder's responsibility.
10.9 Insulation properties			
10.9.2 Power-frequency electric strength			Is the panel builder's responsibility.
10.9.3 Impulse withstand voltage			Is the panel builder's responsibility.
10.9.4 Testing of enclosures made of insulating material			Is the panel builder's responsibility.
10.10 Temperature rise			The panel builder is responsible for the temperature rise calculation. Eaton will provide heat dissipation data for the devices.
10.11 Short-circuit rating			Is the panel builder's responsibility. The specifications for the switchgear must be observed.
10.12 Electromagnetic compatibility			Is the panel builder's responsibility. The specifications for the switchgear must be observed.
10.13 Mechanical function			The device meets the requirements, provided the information in the instruction leaflet (IL) is observed.

## Technical data ETIM 6.0

Low-voltage industrial components (EG000017) / Power circuit-breaker for trafo/generator/installation prot. (EC000228)		
Electric engineering, automation, process control engineering / Low-voltage switch technology / Circuit breaker (LV < 1 kV) / Circuit breaker for power transformer, generator and system protection (ecl@ss8.1-27-37-04-09 [AJZ716010])		
Rated permanent current I <sub>u</sub>	A	160
Rated voltage	V	50 - 550
Rated short-circuit breaking capacity I <sub>cu</sub> at 400 V, 50 Hz	kA	150
Overload release current setting	A	125 - 160
Adjustment range short-term delayed short-circuit release	A	960 - 1600
Adjustment range undelayed short-circuit release	A	0 - 0
Integrated earth fault protection		No
Type of electrical connection of main circuit		Screw connection
Device construction		Built-in device plug-in technique
Suitable for DIN rail (top hat rail) mounting		No
DIN rail (top hat rail) mounting optional		No
Number of auxiliary contacts as normally closed contact		0
Number of auxiliary contacts as normally open contact		0
Number of auxiliary contacts as change-over contact		0
Switched-off indicator available		No
With under voltage release		No
Number of poles		3
Position of connection for main current circuit		Front side
Type of control element		Rocker lever
Complete device with protection unit		Yes
Motor drive integrated		No
Motor drive optional		Yes
Degree of protection (IP)		IP20

# Characteristics

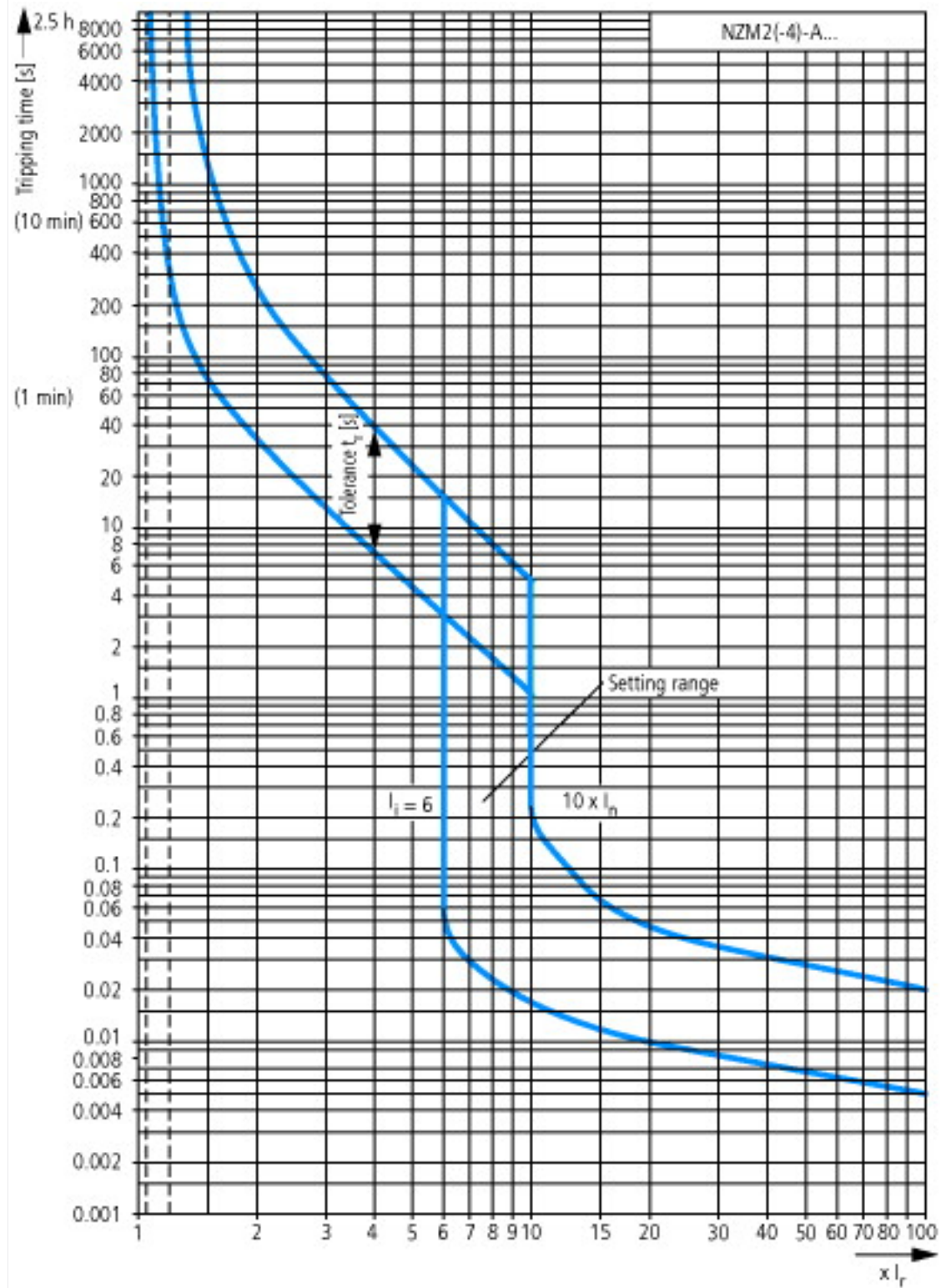

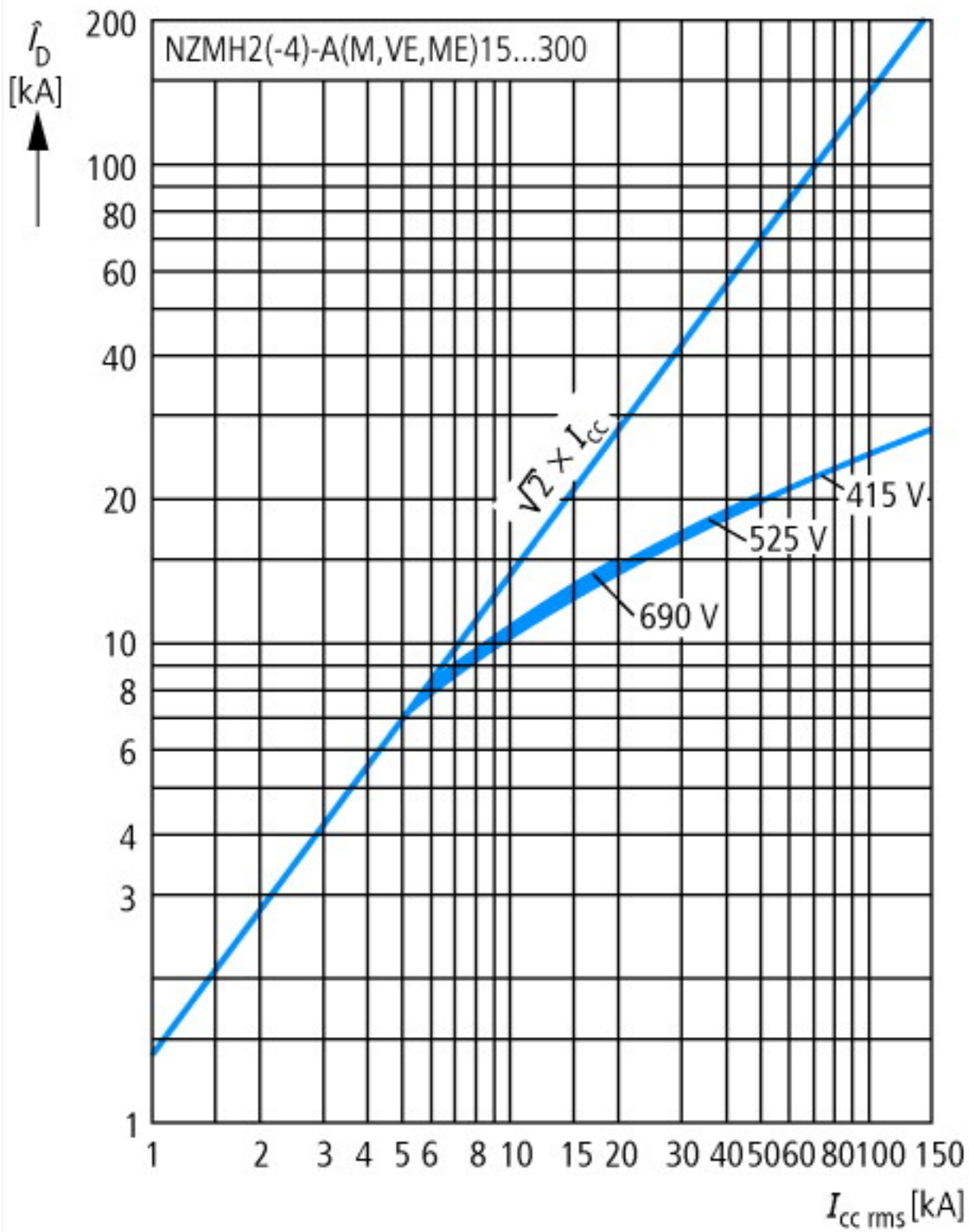

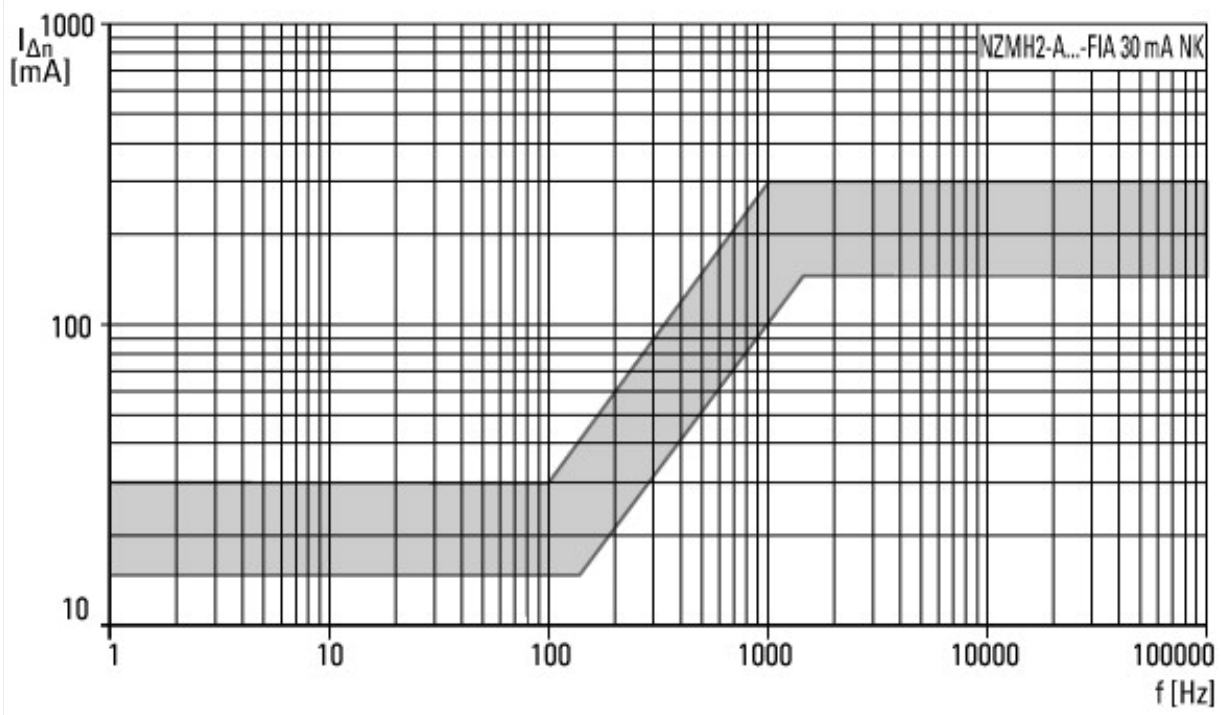



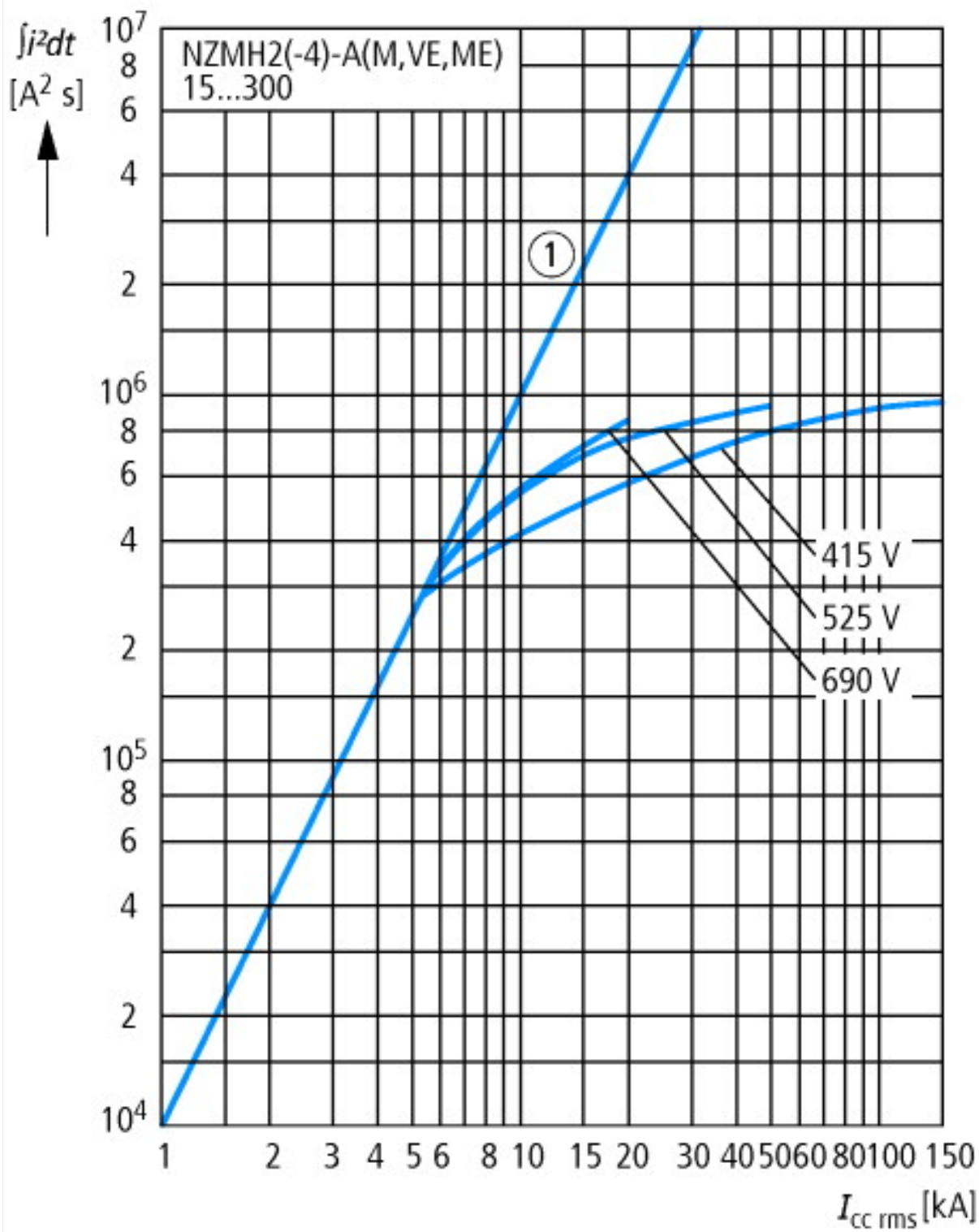

# Dimensions

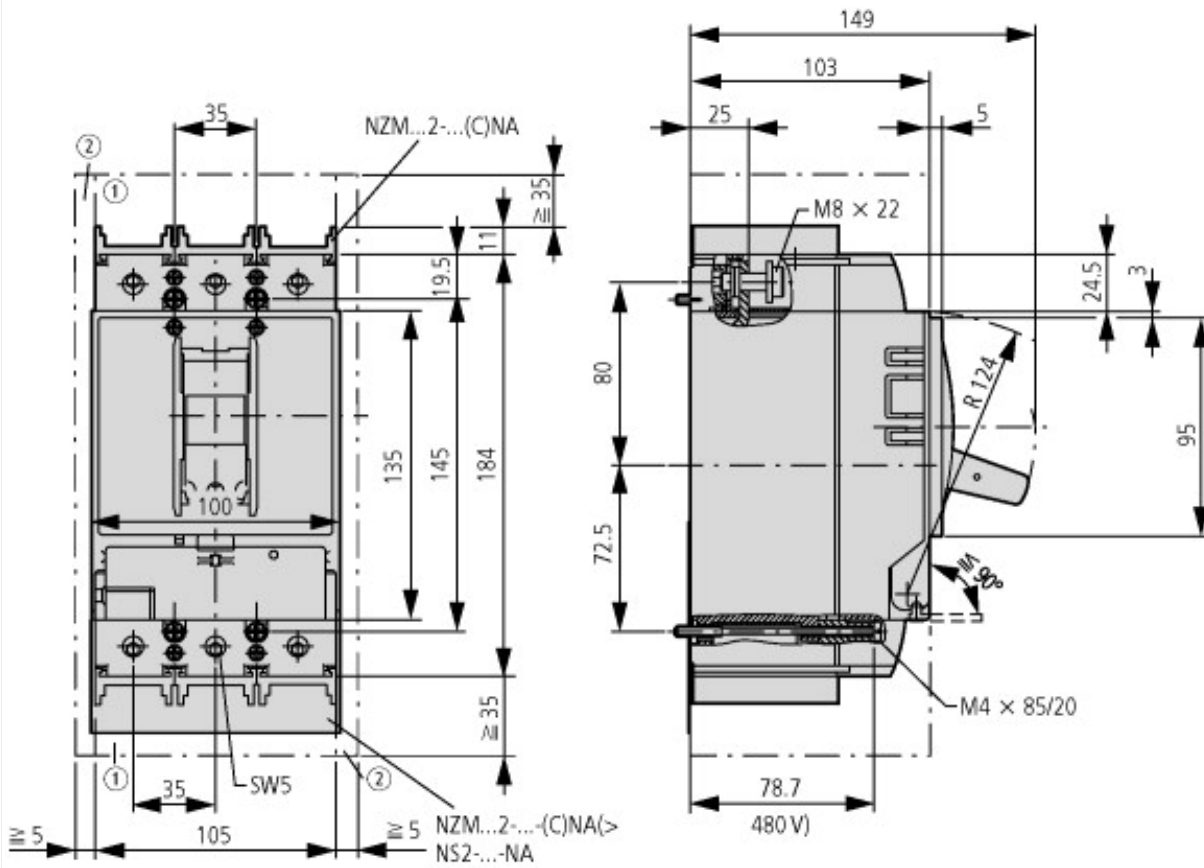

- ① Blow out area, minimum clearance to adjacent parts
- ② Minimum clearance to adjacent parts

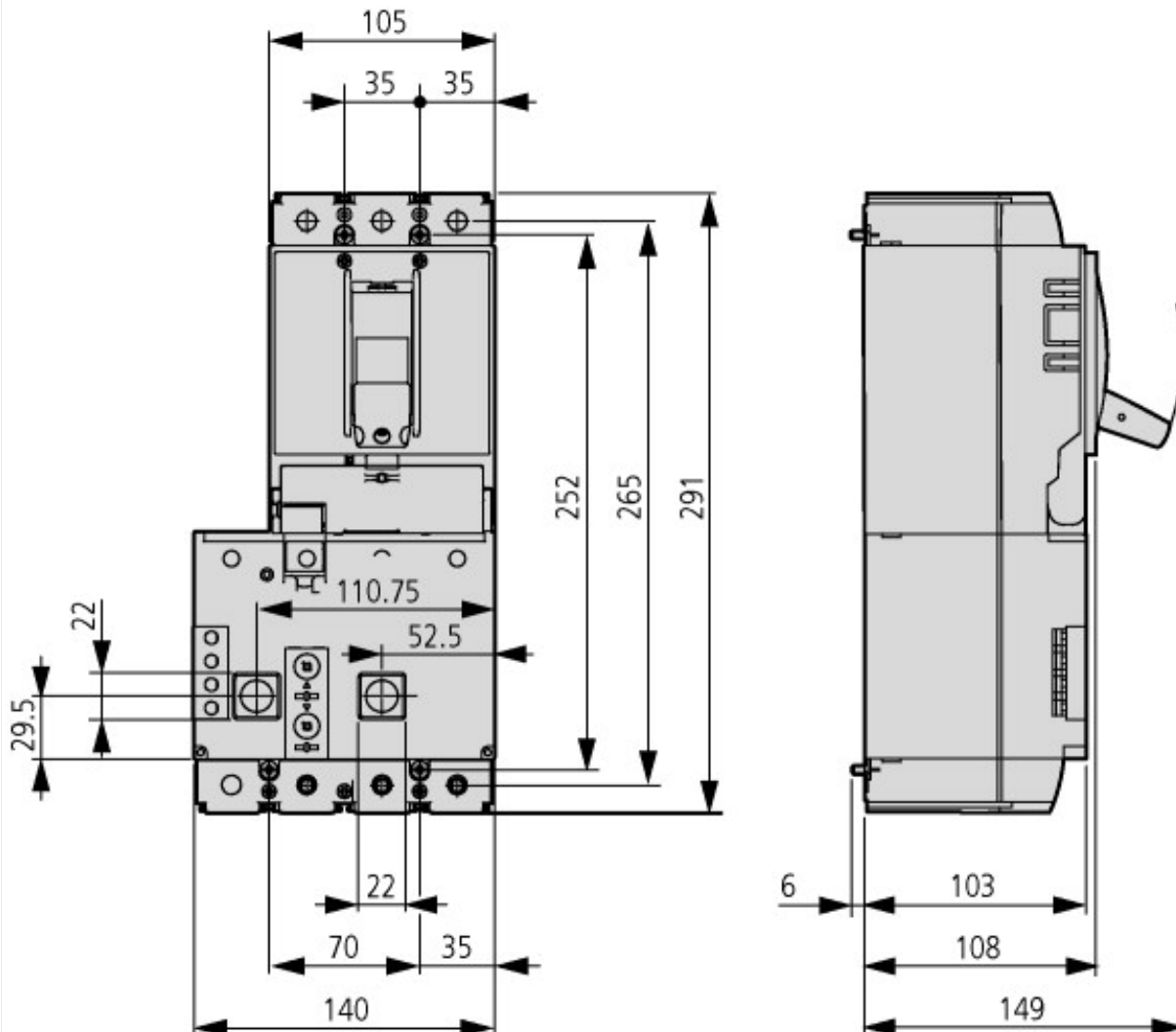

## Additional product information (links)

### IL01219040Z Residual current device with 3 pole NZM2, AC/DC

IL01219040Z Residual current device with 3 pole NZM2, AC/DC	<a href="ftp://ftp.moeller.net/DOCUMENTATION/AWA_INSTRUCTIONS/IL01219040Z2016_03.pdf">ftp://ftp.moeller.net/DOCUMENTATION/AWA_INSTRUCTIONS/IL01219040Z2016_03.pdf</a>
Weight	<a href="http://ecat.moeller.net/flip-cat/?edition=HPLEN&amp;startpage=17.171">http://ecat.moeller.net/flip-cat/?edition=HPLEN&amp;startpage=17.171</a>
Temperature dependency, Derating	<a href="http://ecat.moeller.net/flip-cat/?edition=HPLEN&amp;startpage=17.172">http://ecat.moeller.net/flip-cat/?edition=HPLEN&amp;startpage=17.172</a>
Effective power loss	<a href="http://ecat.moeller.net/flip-cat/?edition=HPLEN&amp;startpage=17.174">http://ecat.moeller.net/flip-cat/?edition=HPLEN&amp;startpage=17.174</a>
CurveSelect characteristics program	<a href="http://www.eaton.eu/DE/Europe/Electrical/CustomerSupport/ConfigurationTools/CharacteristicsProgram/index.htm">http://www.eaton.eu/DE/Europe/Electrical/CustomerSupport/ConfigurationTools/CharacteristicsProgram/index.htm</a>