

Low-Power, High-Speed CMOS Analog Switches

DESCRIPTION

The DG401, DG403, DG405 monolithic analog switches were designed to provide precision, high performance switching of analog signals. Combining low power (0.35 μ W, typ.) with high speed (t_{ON} : 75 ns, typ.), the DG401 series is ideally suited for portable and battery powered industrial and military applications.

Built on the Vishay Siliconix proprietary high-voltage silicon-gate process to achieve high voltage rating and superior switch on/off performance, break-before-make is guaranteed for the SPDT configurations. An epitaxial layer prevents latchup.

Each switch conducts equally well in both directions when on, and blocks up to 30 V peak-to-peak when off. On-resistance is very flat over the full ± 15 V analog range, rivaling JFET performance without the inherent dynamic range limitations.

The three devices in this series are differentiated by the type of switch action as shown in the functional block diagrams.

FEATURES

- 44 V supply max. rating
- ± 15 V analog signal range
- On-resistance - $R_{DS(on)}$: 30 Ω
- Low leakage - $I_{D(on)}$: 40 pA
- Fast switching - t_{ON} : 75 ns
- Ultra low power requirements - P_D : 0.35 μ W
- TTL, CMOS compatible
- Single supply capability
- **Compliant to RoHS directive 2002/95/EC**



RoHS*
COMPLIANT

BENEFITS

- Wide dynamic range
- Break-before-make switching action
- Simple interfacing

APPLICATIONS

- Audio and video switching
- Sample-and-hold circuits
- Battery operation
- Test equipment
- Communications systems
- PBX, PABX

FUNCTIONAL BLOCK DIAGRAM AND PIN CONFIGURATION



Two SPST Switches per Package

TRUTH TABLE	
Logic	Switch
0	OFF
1	ON

Logic "0" ≤ 0.8 V
Logic "1" ≥ 2.4 V

* Pb containing terminations are not RoHS compliant, exemptions may apply

FUNCTIONAL BLOCK DIAGRAM AND PIN CONFIGURATION

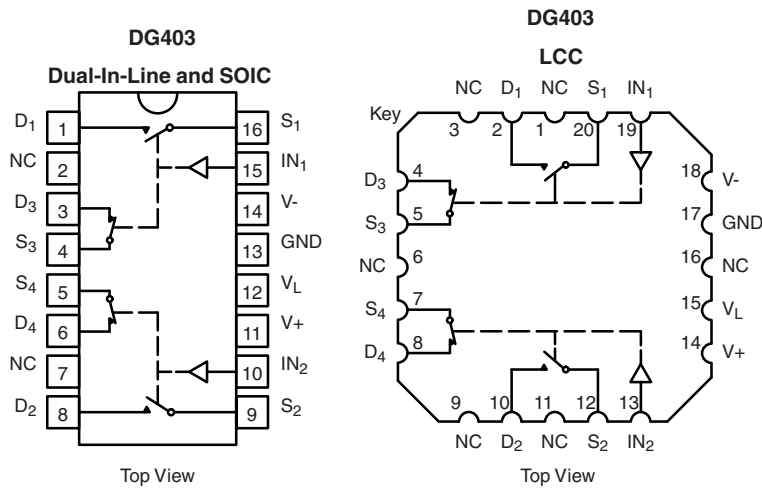

Two SPDT Switches per Package

TRUTH TABLE		
Logic	SW ₁ , SW ₂	SW ₃ , SW ₄
0	OFF	ON
1	ON	OFF

Logic "0" ≤ 0.8 V
Logic "1" ≥ 2.4 V



Two DPST Switches per Package

TRUTH TABLE	
Logic	Switch
0	OFF
1	ON

Logic "0" ≤ 0.8 V
Logic "1" ≥ 2.4 V



ORDERING INFORMATION		
Temp. Range	Package	Part Number
DG401		
- 40 °C to 85 °C	16-Pin Plastic DIP	DG401DJ DG401DJ-E3
	16-Pin Narrow SOIC	DG401DY DG401DY-T1 DG401DY-E3 DG401DY-T1-E3
DG403		
- 40 °C to 85 °C	16-Pin Plastic DIP	DG403DJ DG403DJ-E3
	16-Pin Narrow SOIC	DG403DY DG403DY-E3 DG403DY-T1 DG403DY-T1-E3
DG405		
- 40 °C to 85 °C	16-Pin Plastic DIP	DG405DJ DG405DJ-E3
	16-Pin Narrow SOIC	DG405DY DG405DY-E3 DG405DY-T1 DG405DY-T1-E3

ABSOLUTE MAXIMUM RATINGS			
Parameter	Limit	Unit	
V+ to V-	44	V	
GND to V-	25		
V _L	(GND - 0.3) to (V+) + 0.3		
Digital Inputs ^a , V _S , V _D	(V-) - 2 to (V+) + 2 or 30 mA, whichever occurs first		
Current (Any Terminal) Continuous	30	mA	
Current, S or D (Pulsed 1 ms, 10 % Duty)	100		
Storage Temperature	(DJ, DY Suffix) - 65 to 125	°C	
Power Dissipation (Package) ^b	16-Pin Plastic DIP ^c	450	mW
	16-Pin SOIC ^d	600	

Notes:

- Signals on S_x, D_x, or IN_x exceeding V+ or V- will be clamped by internal diodes. Limit forward diode current to maximum current ratings.
- All leads welded or soldered to PC board.
- Derate 6 mW/°C above 75 °C.
- Derate 7.6 mW/°C above 75 °C.

SPECIFICATIONS ^a							
Parameter	Symbol	Test Conditions Unless Specified V ₊ = 15 V, V ₋ = - 15 V V _L = 5 V, V _{IN} = 2.4 V, 0.8 V ^f	Temp. ^b	Typ. ^c	D Suffix - 40 °C to 85 °C		Unit
					Min. ^d	Max. ^d	
Analog Switch							
Analog Signal Range ^e	V _{ANALOG}		Full		- 15	15	V
Drain-Source On-Resistance	R _{DS(on)}	I _S = - 10 mA, V _D = ± 10 V V ₊ = 13.5 V, V ₋ = - 13.5 V	Room Full	30		45 55	Ω
Δ Drain-Source On-Resistance	ΔR _{DS(on)}	I _S = - 10 mA, V _D = ± 5 V, 0 V V ₊ = 16.5 V, V ₋ = - 16.5 V	Room Full	3		3 5	
Switch Off Leakage Current	I _{S(off)}	V ₊ = 16.5 V, V ₋ = - 16.5 V V _D = ± 15.5 V, V _S = ± 15.5 V	Room Hot	- 0.01	- 0.5 - 5	0.5 5	nA
	I _{D(off)}		Room Hot	- 0.01	- 0.5 - 5	0.5 5	
Channel On Leakage Current	I _{D(on)}	V ₊ = 16.5 V, V ₋ = - 16.5 V V _S = V _D = ± 15.5 V	Room Hot	- 0.04	- 1 - 10	1 10	
Digital Control							
Input Current V _{IN} Low	I _{IL}	V _{IN} under test = 0.8 V All Other = 2.4 V	Full	0.005	- 1	1	μA
Input Current V _{IN} High	I _{IH}	V _{IN} under test = 2.4 V All Other = 0.8 V	Full	0.005	- 1	1	
Dynamic Characteristics							
Turn-On Time	t _{ON}	R _L = 300 Ω, C _L = 35 pF See Figure 2	Room	75		150	ns
Turn-Off Time	t _{OFF}		Room	30		100	
Break-Before-Make Time Delay (DG403)	t _D	R _L = 300 Ω, C _L = 35 pF	Room	35	5		
Charge Injection	Q	C _L = 10 nF V _{gen} = 0 V, R _{gen} = 0 Ω	Room	60			pC
Off Isolation Reject Ratio	OIRR	R _L = 100 Ω, C _L = 5 pF f = 1 MHz	Room	72			dB
Channel-to-Channel Crosstalk	X _{TALK}		Room	90			
Source Off Capacitance	C _{S(off)}	f = 1 MHz, V _S = 0 V	Room	12			pF
Drain Off Capacitance	C _{D(off)}		Room	12			
Channel On Capacitance	C _D , C _{S(on)}		Room	39			
Power Supplies							
Positive Supply Current	I ₊	V ₊ = 16.5 V, V ₋ = - 16.5 V V _{IN} = 0 or 5 V	Room Full	0.01		1 5	μA
Negative Supply Current	I ₋		Room Full	- 0.01	- 1 - 5		
Logic Supply Current	I _L		Room Full	0.01		1 5	
Ground Current	I _{GND}		Room Full	- 0.01	- 1 - 5		

Notes:

- Refer to PROCESS OPTION FLOWCHART.
- Room = 25 °C, Full = as determined by the operating temperature suffix.
- Typical values are for DESIGN AID ONLY, not guaranteed nor subject to production testing.
- The algebraic convention whereby the most negative value is a minimum and the most positive a maximum, is used in this datasheet.
- Guaranteed by design, not subject to production test.
- V_{IN} = input voltage to perform proper function.

Stresses beyond those listed under "Absolute Maximum Ratings" may cause permanent damage to the device. These are stress ratings only, and functional operation of the device at these or any other conditions beyond those indicated in the operational sections of the specifications is not implied. Exposure to absolute maximum rating conditions for extended periods may affect device reliability.

TYPICAL CHARACTERISTICS 25 °C, unless otherwise noted



Input Switching Threshold vs. Logic Supply Voltage

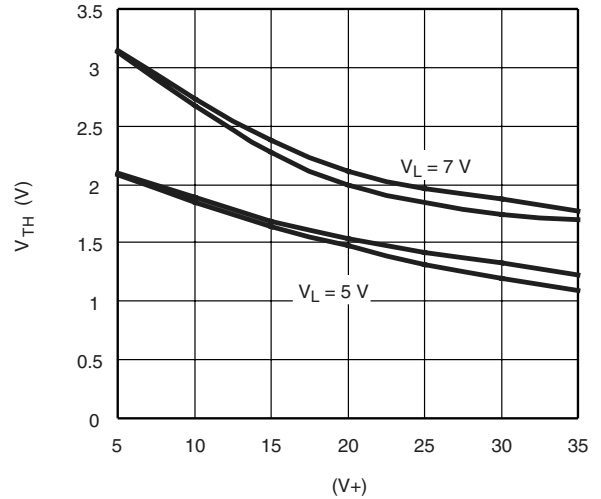

Input Switching Threshold vs. Supply Voltages



R_{DS(on)} vs. V_D and Temperature



R_{DS(on)} vs. V_D and Power Supply Voltage

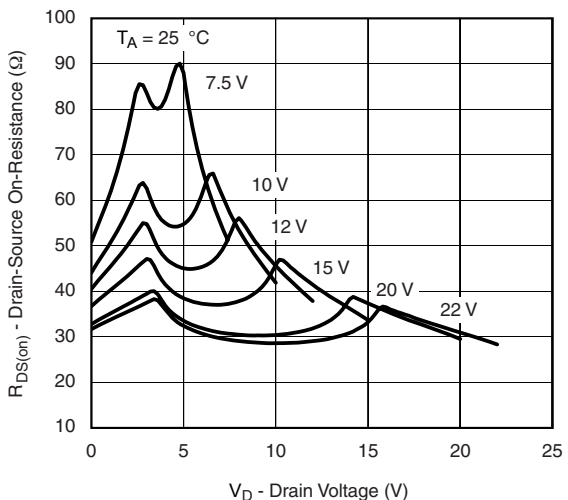

R_{DS(on)} vs. V_D and Power Supply Voltage (V₋ = 0 V)

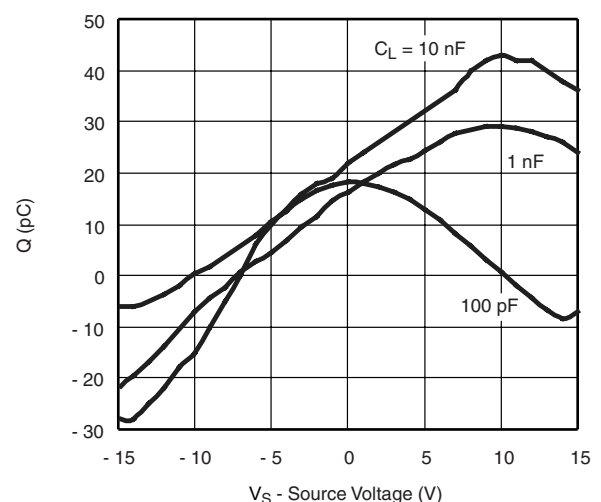

Charge Injection vs. Analog Voltage

TYPICAL CHARACTERISTICS 25 °C, unless otherwise noted



Leakage Current vs. Temperature



Leakage Current vs. Analog Voltage

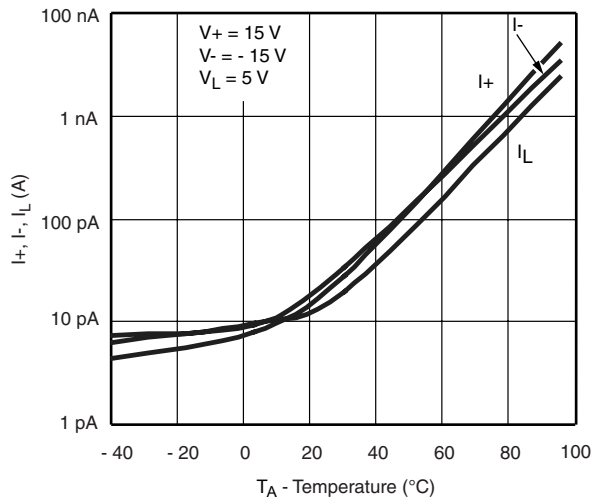

Supply Current vs. Temperature

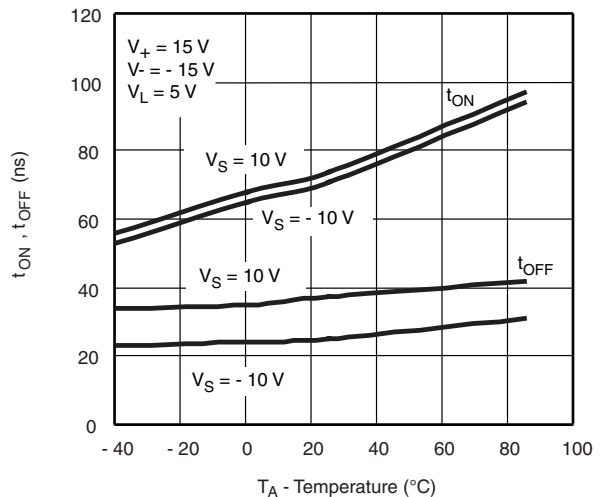

Switching Time vs. Temperature*



Switching Time vs. Power Supply Voltage*

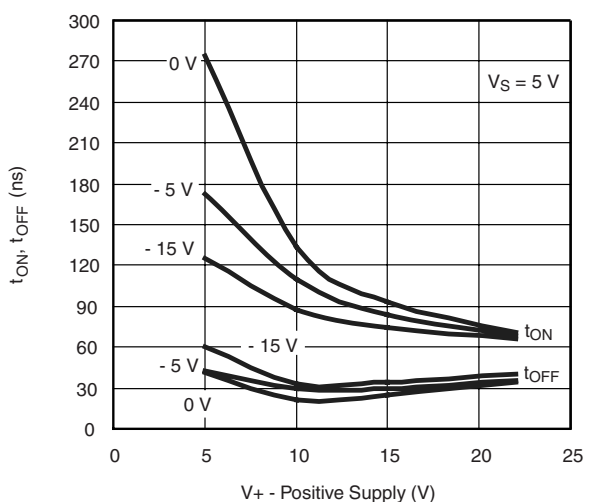

Switching Time vs. Positive Supply Voltage*

* Refer to Figure 2 for test conditions.

TYPICAL CHARACTERISTICS 25 °C, unless otherwise noted



Supply Current vs. Switching Frequency

SCHEMATIC DIAGRAM Typical Channel



Figure 1.

TEST CIRCUITS

V_O is the steady state output with the switch on. Feedthrough via switch capacitance may result in spikes at the leading and trailing edge of the output waveform.



C_L (includes fixture and stray capacitance)

$$V_O = V_S \frac{R_L}{R_L + r_{DS(on)}}$$

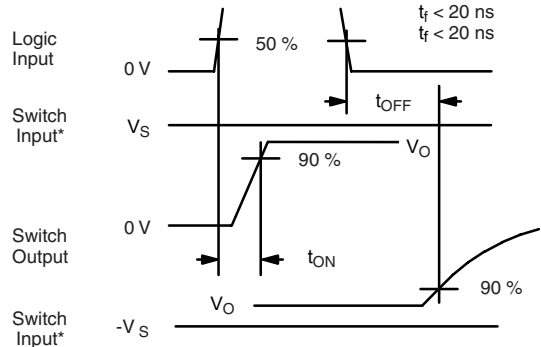

* $V_S = 10\text{ V}$ for t_{ON} , $V_S = -10\text{ V}$ for t_{OFF}

Note: Logic input waveform is inverted for switches that have the opposite logic sense control

Figure 2. Switching Time



C_L (includes fixture and stray capacitance)

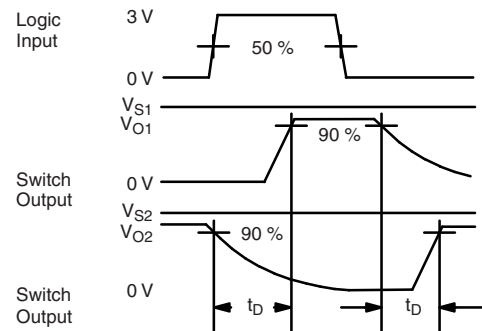

Figure 3. Break-Before-Make



Figure 4. Charge Injection

TEST CIRCUITS



Figure 5. Off Isolation



Figure 7. Crosstalk



Figure 6. Insertion Loss



Figure 8. Capacitances

APPLICATIONS



Figure 9. Stereo Source Selector



Figure 10. Dual Slope Integrator

Dual Slope Integrators:

The DG403 is well suited to configure a selectable slope integrator. One control signal selects the timing capacitor C_1 or C_2 . Another one selects e_{in} or discharges the capacitor in preparation for the next integration cycle.

Band-Pass Switched Capacitor Filter:

Single-pole double-throw switches are a common element for switched capacitor networks and filters. The fast switching times and low leakage of the DG403 allow for higher clock rates and consequently higher filter operating frequencies.



Figure 11. Band-Pass Switched Capacitor Filter

APPLICATIONS
Peak Detector:

A_3 acting as a comparator provides the logic drive for operating SW_1 . The output of A_2 is fed back to A_3 and compared to the analog input e_{in} . If $e_{in} > e_{out}$ the output of A_3 is high keeping SW_1 closed. This allows C_1 to charge up to

the analog input voltage. When e_{in} goes below e_{out} A_3 goes negative, turning SW_1 off. The system will therefore store the most positive analog input experienced.



Figure 12. Positive Peak Detector

Vishay Siliconix maintains worldwide manufacturing capability. Products may be manufactured at one of several qualified locations. Reliability data for Silicon Technology and Package Reliability represent a composite of all qualified locations. For related documents such as package/tape drawings, part marking, and reliability data, see www.vishay.com/ppg?70049.



SOIC (NARROW): 16-LEAD
JEDEC Part Number: MS-012



Dim	MILLIMETERS		INCHES	
	Min	Max	Min	Max
A	1.35	1.75	0.053	0.069
A ₁	0.10	0.20	0.004	0.008
B	0.38	0.51	0.015	0.020
C	0.18	0.23	0.007	0.009
D	9.80	10.00	0.385	0.393
E	3.80	4.00	0.149	0.157
e	1.27 BSC		0.050 BSC	
H	5.80	6.20	0.228	0.244
L	0.50	0.93	0.020	0.037
∅	0°	8°	0°	8°

ECN: S-03946—Rev. F, 09-Jul-01
DWG: 5300



PDIP: 16-LEAD



Dim	MILLIMETERS		INCHES	
	Min	Max	Min	Max
A	3.81	5.08	0.150	0.200
A₁	0.38	1.27	0.015	0.050
B	0.38	0.51	0.015	0.020
B₁	0.89	1.65	0.035	0.065
C	0.20	0.30	0.008	0.012
D	18.93	21.33	0.745	0.840
E	7.62	8.26	0.300	0.325
E₁	5.59	7.11	0.220	0.280
e₁	2.29	2.79	0.090	0.110
e_A	7.37	7.87	0.290	0.310
L	2.79	3.81	0.110	0.150
Q₁	1.27	2.03	0.050	0.080
S	0.38	1.52	.015	0.060

ECN: S-03946—Rev. D, 09-Jul-01
DWG: 5482



CERDIP: 16-LEAD



Dim	MILLIMETERS		INCHES	
	Min	Max	Min	Max
A	4.06	5.08	0.160	0.200
A ₁	0.51	1.14	0.020	0.045
B	0.38	0.51	0.015	0.020
B ₁	1.14	1.65	0.045	0.065
C	0.20	0.30	0.008	0.012
D	19.05	19.56	0.750	0.770
E	7.62	8.26	0.300	0.325
E ₁	6.60	7.62	0.260	0.300
e ₁	2.54 BSC		0.100 BSC	
e _A	7.62 BSC		0.300 BSC	
L	3.18	3.81	0.125	0.150
L ₁	3.81	5.08	0.150	0.200
Q ₁	1.27	2.16	0.050	0.085
S	0.38	1.14	0.015	0.045
∞	0°	15°	0°	15°

ECN: S-03946—Rev. G, 09-Jul-01
DWG: 5403



20-LEAD LCC



Dim	MILLIMETERS		INCHES	
	Min	Max	Min	Max
A	1.37	2.24	0.054	0.088
A₁	1.63	2.54	0.064	0.100
B	0.56	0.71	0.022	0.028
D	8.69	9.09	0.342	0.358
E	8.69	9.09	0.442	0.358
e	1.27 BSC		0.050 BSC	
L	1.14	1.40	0.045	0.055
L₁	1.96	2.36	0.077	0.093

ECN: S-03946—Rev. B, 09-Jul-01
DWG: 5321

RECOMMENDED MINIMUM PADS FOR SO-16



Recommended Minimum Pads
Dimensions in Inches/(mm)

[Return to Index](#)



Disclaimer

ALL PRODUCT, PRODUCT SPECIFICATIONS AND DATA ARE SUBJECT TO CHANGE WITHOUT NOTICE TO IMPROVE RELIABILITY, FUNCTION OR DESIGN OR OTHERWISE.

Vishay Intertechnology, Inc., its affiliates, agents, and employees, and all persons acting on its or their behalf (collectively, "Vishay"), disclaim any and all liability for any errors, inaccuracies or incompleteness contained in any datasheet or in any other disclosure relating to any product.

Vishay makes no warranty, representation or guarantee regarding the suitability of the products for any particular purpose or the continuing production of any product. To the maximum extent permitted by applicable law, Vishay disclaims (i) any and all liability arising out of the application or use of any product, (ii) any and all liability, including without limitation special, consequential or incidental damages, and (iii) any and all implied warranties, including warranties of fitness for particular purpose, non-infringement and merchantability.

Statements regarding the suitability of products for certain types of applications are based on Vishay's knowledge of typical requirements that are often placed on Vishay products in generic applications. Such statements are not binding statements about the suitability of products for a particular application. It is the customer's responsibility to validate that a particular product with the properties described in the product specification is suitable for use in a particular application. Parameters provided in datasheets and / or specifications may vary in different applications and performance may vary over time. All operating parameters, including typical parameters, must be validated for each customer application by the customer's technical experts. Product specifications do not expand or otherwise modify Vishay's terms and conditions of purchase, including but not limited to the warranty expressed therein.

Except as expressly indicated in writing, Vishay products are not designed for use in medical, life-saving, or life-sustaining applications or for any other application in which the failure of the Vishay product could result in personal injury or death. Customers using or selling Vishay products not expressly indicated for use in such applications do so at their own risk. Please contact authorized Vishay personnel to obtain written terms and conditions regarding products designed for such applications.

No license, express or implied, by estoppel or otherwise, to any intellectual property rights is granted by this document or by any conduct of Vishay. Product names and markings noted herein may be trademarks of their respective owners.