

Circuit Breaker for Equipment thermal-magnetic, Flange type, Manual ON/OFF, Screw terminals



See below:

**Approvals and Compliances**

**Description**

- Flange type
- Thermal-magnetic circuit breaker
- 1-pole
- Manual ON/OFF type
- Insensitive to shock or vibration
- Bolts and nuts

**Unique Selling Proposition**

- Tripping characteristic Fast or Slow
- Positively trip-free release
- Available with cover
- Different mounting possibilities

**Applications**

- Power supplies
- Uninterruptible power supply
- Power tools
- Household appliances

**Weblinks**

[pdf datasheet](#), [html-datasheet](#), [General Product Information](#), [Distributor-Stock-Check](#), [Detailed request for product](#), [Product News](#)

**Technical Data**

Rated Voltage AC	240 V: 50/60 Hz
Rated Voltage DC	28 V
Rated current range AC	0.05 - 15 A , see approbations
Conditional short circuit capacity	IEC: Inc, PC1, AC 240 V: 1 kA
Short circuit capacity Icn	AC 240 V : 200 A AC/DC 28 V : 400 A
Degree of Protection	from front side IP 40 acc. to IEC 60529
Dielectric Strength	50Hz: > 1.5 kV Impulse 1.2/50 µs: > 2.5 kV
Insulation Resistance	500 VDC > 100 MΩ
Endurance typical	2 x Ir: 5000 switching cycles
Endurance minimum	Manual ON/OFF type AC : 2 x Ir , cos φ 0.6 :  DC : 2 x Ir , L/R = 2 - 3 ms : 5000 switching cycles

Overload	IEC: min. 40 trips @ 6 x Ir, cos φ 0.6 UL / CSA: min. 50 trips @ 1.5 x Ir, cos φ 0.75
Allowable Operation Temp.	-5 °C to 60 °C
Vibration Resistance	± 1.5 mm @ 10 - 60 Hz acc. to IEC 60068-2-6, test Fc 10 G @ 60 - 500 Hz acc. to IEC 60068-2-6, test Fc
Shock Resistance	100 G / 6ms acc. to IEC 60068-2-27, test Ea
Tripping Type	Thermal-Magnetic
Actuation Type	Manual ON/OFF
Weight	ca. 10g

**Approvals and Compliances**

Detailed information on product approvals, code requirements, usage instructions and detailed test conditions can be looked up in [Details about Approvals](#)



**Approvals**

The approval mark is used by the testing authorities to certify compliance with the safety requirements placed on electronic products.  
 Approval Reference Type: TM12

Approval Logo	Certificates	Certification Body	Description
	VDE Approvals	VDE	VDE Certificate Number: 99673
	UL Approvals	UL	UL File Number: E71572
	CSA Approvals	CSA	CSA Certification Record: LR 37712
	CQC Approvals	CQC	CQC Certificate Number: 2012010307564275

## Product standards

Product standards that are referenced

Organization	Design	Standard	Description
	Designed according to	IEC 60934	Circuit-breakers for equipment (CBE)
	Designed according to	UL 1077	Standard for Supplementary Protectors for Use in Electrical Equipment
	Designed according to	GB 17701	Circuit-breaker for equipment





## Application standards

Application standards where the product can be used

Organization	Design	Standard	Description
	Designed for applications acc.	IEC/UL 60950	IEC 60950-1 includes the basic requirements for the safety of information technology equipment.

## Compliances

The product complies with following Guide Lines

Identification	Details	Initiator	Description
	CE declaration of conformity	SCHURTER AG	The CE marking declares that the product complies with the applicable requirements laid down in the harmonisation of Community legislation on its affixing in accordance with EU Regulation 765/2008.
	RoHS	SCHURTER AG	EU Directive RoHS 2011/65/EU
	China RoHS	SCHURTER AG	The law SJ / T 11363-2006 (China RoHS) has been in force since 1 March 2007. It is similar to the EU directive RoHS.
	REACH	SCHURTER AG	On 1 June 2007, Regulation (EC) No 1907/2006 on the Registration, Evaluation, Authorization and Restriction of Chemicals 1 (abbreviated as "REACH") entered into force.

## Dimension [mm]

TMx12-112

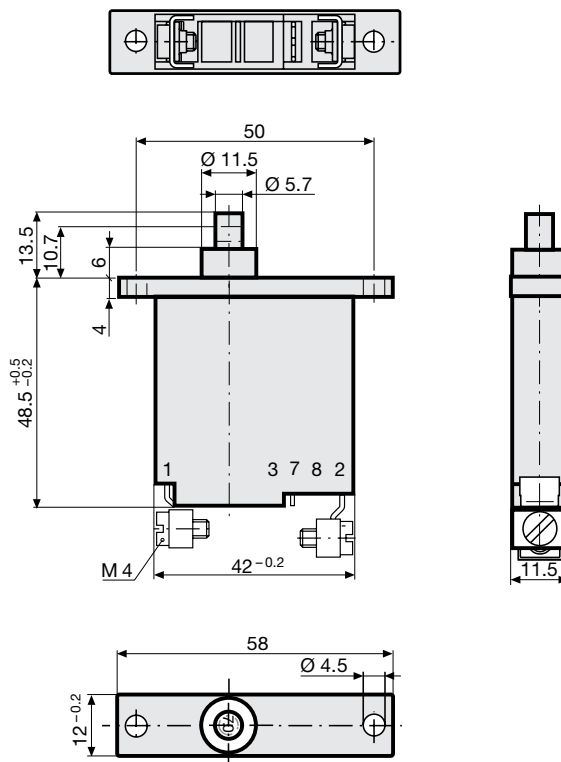

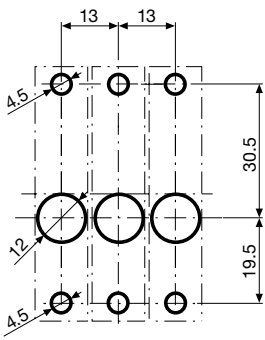

Installation from rear

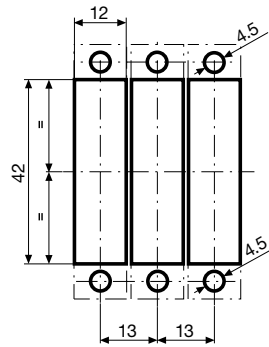

Installation from front

Diagrams

Tap 4,8 x 0,8 mm

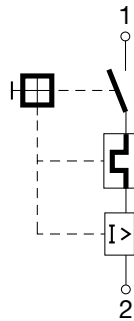

Tap 4,8 x 0,8 mm

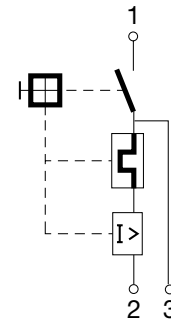

Tap 4,8 x 0,8 mm

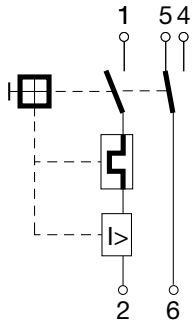

Tap 4,8 x 0,8 mm

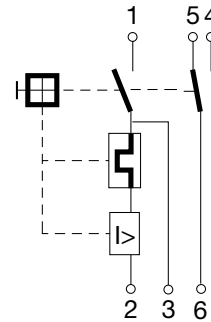

Approval		Main circuit			Auxiliary circuit		
		Rated current	Rated Voltage AC	Rated Voltage DC	Rated current	Rated Voltage AC	Rated Voltage DC
	UL 1077	0.05...15 A	240 V	28 V	2 A	120 V	-
	CSA C22.2 No. 235				3 A	-	28 V
	CSA C22.2 No. 235	0.05...16 A	240 V	28 V	1 A	240 V	-
	EN 60934	0.05...16 A	240 V	28 V	1 A	240 V	28 V
	GB 17701	0.05...16 A	240 V	28 V	1 A	240 V	28 V

## Typical internal resistance TMF12

Rated Current [A]	Internal Resistance [ $\Omega$ ]
0.05	335.00
0.50	4.37
1.00	1.23
2.00	0.369
3.00	0.181
4.00	0.097
5.00	0.055
6.00	0.044
7.00	0.0231
8.00	0.0227
9.00	0.0142
10.00	0.0123
11.00	0.012
12.00	0.012
13.00	0.0108
14.00	0.0091
15.00	0.0089
16.00	0.0071

## Typical internal resistance TMT12

Rated Current [A]	Internal Resistance [ $\Omega$ ]
0.05	260.00
0.50	4.03
1.00	1.006
2.00	0.323
3.00	0.161
4.00	0.086
5.00	0.0494
6.00	0.0396
7.00	0.0257
8.00	0.0249
9.00	0.0129
10.00	0.0112
11.00	0.0111
12.00	0.0111
13.00	0.0109
14.00	0.0092
15.00	0.0090
16.00	0.0075

## Effect of ambient temperature

The units are calibrated for an ambient temperature of +23°C. To determine the rated current for a lower or higher ambient temperature, use a correction factor (typical value) from the table below:

Ambient Temperature [°C]	Correction factor
-5	0.87
0	0.90
10	0.95
23	1.00
30	1.05
40	1.12
50	1.20
60	1.30

Example: Rated current = 5 A, Environmental temperature = 50 °C, --> Correction factor = 1.2, Resulting current = 6.0 A

**Time-Current-Curves**

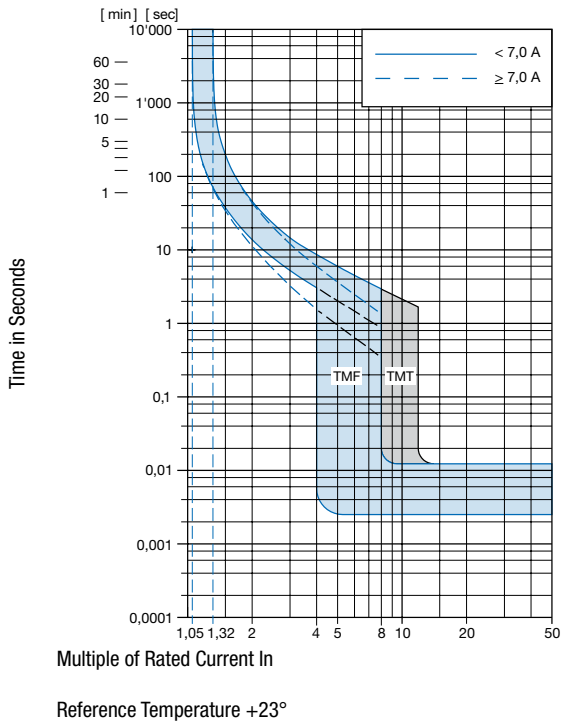

**Config. Code**

TM F 12 - 1 2 3 A B C - 1.23

The characters are placeholders for the correspondingly keys of selections from the key tables.

TM **F** 12 - 1 2 3 A B C - 1.23 = Magnetic release range

Magnetic release range	Configuration key
Fast	F
Slow	T

TM F 12 - **1** 2 3 A B C - 1.23 = Mounting

Mounting	Configuration key
Screwflange mounting	1

TM F 12 - 1 **2** 3 A B C - 1.23 = Actuation Type

Actuation Type	Configuration key
Manual ON/OFF (push/push)	2

TM F 12 - 1 2 **3** A B C - 1.23 = Terminal

Terminal	Configuration key
Screw clamp terminals	2

TM F 12 - 1 2 3 **A** B C - 1.23 = Auxiliary contact

Auxiliary contact	Configuration key
Auxiliary contact	S

TM F 12 - 1 2 3 A **B** C - 1.23 = Shunt terminal

Shunt terminal	Configuration key
Shunt terminal	N

TM F 12 - 1 2 3 A B **C** - 1.23 = Setting indication

Setting indication	Configuration key
Setting indication	R

TM F 12 - 1 2 3 A B C - **1.23** = Rated current

Rated current	Configuration key
0.05 A	0.05
0.1 A	0.1
0.15 A	0.15
0.2 A	0.2
0.3 A	0.3
0.4 A	0.4
0.5 A	0.5

Other rated currents on request

Rated current	Configuration key
0.6 A	0.6
0.7 A	0.7
0.8 A	0.8
0.9 A	0.9
1.0	1
1.1 A	1.1
1.2 A	1.2
1.3 A	1.3
1.4 A	1.4
1.5 A	1.5
1.6 A	1.6
1.7 A	1.7
1.8 A	1.8
1.9 A	1.9
2.0 A	2
2.1 A	2.1
2.3 A	2.3
2.5 A	2.5
2.8 A	2.8
3.0 A	3
3.3 A	3.3

Other rated currents on request

Rated current	Configuration key
3.5 A	3.5
4.0 A	4
4.5 A	4.5
5.0 A	5
5.5 A	5.5
6.0	6
6.5 A	6.5
7.0 A	7
7.5 A	7.5
8.0 A	8
8.5 A	8.5
9.0 A	9
9.5 A	9.5
10.0 A	10
11.0 A	11
12.0 A	12
13.0 A	13
14.0 A	14
15.0 A	15
16.0 A	16

Other rated currents on request

## Variants

Rated current	Construction variants			Config. Code	Order Number
	Auxiliary contact	Shunt terminal	Setting indication		
1.0			●	TMF12-122R-1	4410.0818
3.0 A			●	TMF12-122R-3	4410.0819
5.0 A			●	TMF12-122R-5	4410.0820

Availability for all products can be searched real-time: <https://www.schurter.com/en/Stock-Check/Stock-Check-SCHURTER>

**Packaging Unit** 20 Pcs

## Accessories

### Description



T-Line Accessories  
 Accessories to T-Line