

## OT FIT 40/220...240/1A0 LT2 LP

OPTOTRONIC FIT LT2 LP | Compact constant current LED driver – Non dimmable



### Product family features

- Supply voltage: 220...240 V
- Line frequency: 0 Hz | 50 Hz | 60 Hz
- Line voltage: 198...264 V
- According to EN 61347-1, 61347-2-13, 62384
- RI suppression: to EN 55015
- Line harmonics according to EN 61000-3-2
- Immunity according to EN 61547
- Lifetime: up to 100,000 h (temperature at  $T_c = 65^\circ\text{C}$ , max. 10 % failure rate)
- Independent connection via through-looping (depending on version of product)

### Product family benefits

- Versatile scope of application due to output power range of up to 40 W
- Fulfill safety requirement due to overload, overtemperature protection
- High efficiency
- Higher quality of light thanks to < 5% output ripple current

### Areas of application

- Installation in emergency lighting systems according to IEC 61347-2-13, appendix J
- Luminaires with flexible current setting (LEDset2)
- Suitable for indoor SELV installations
- Suitable for luminaires of protection classes I and II
- Suitable for downlights, spotlights and LED panels
- Independent mounting via Cable Clamp Kit possible



## Technical data

### Electrical data

Nominal input voltage	220...240 V
Mains frequency	0/50/60 Hz
Input voltage AC	198...264 V
Input voltage DC	176...276 V
Total harmonic distortion	< 15 %
Power factor $\lambda$	0.98
ECG efficiency	87.5 %
Device power loss	6.0 W
Inrush current	17 A <sup>1)</sup>
Max. ECG no. on circuit breaker 10 A (B)	19
Max. ECG no. on circuit breaker 16 A (B)	30
Max. ECG no. on circuit breaker 25 A (B)	-
Surge capability (L/N-Ground)	2 kV <sup>2)</sup>
Surge capability (L-N)	1 kV
Nominal output voltage	15...50 V
U-OUT (working voltage)	60 V
Nominal output current	500...1050 mA
Output current LEDset open	Not allowed
Output current LEDset shorted	1050 mA
Output current tolerance	±5 %
Output ripple current (100 Hz)	< 5 %
Output PSTLM	≤1
Output SVM	≤0.4
Nominal output power	13...40 W
Galvanic isolation	SELV
Current set	LEDset2

<sup>1)</sup>  $t_{width} = 225 \mu s$  (measured at 50 %  $I_{peak}$ )

<sup>2)</sup> L+N / PE of basic isolated LED module

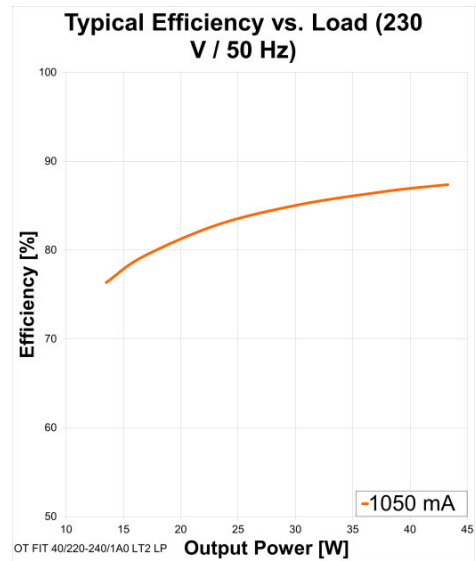
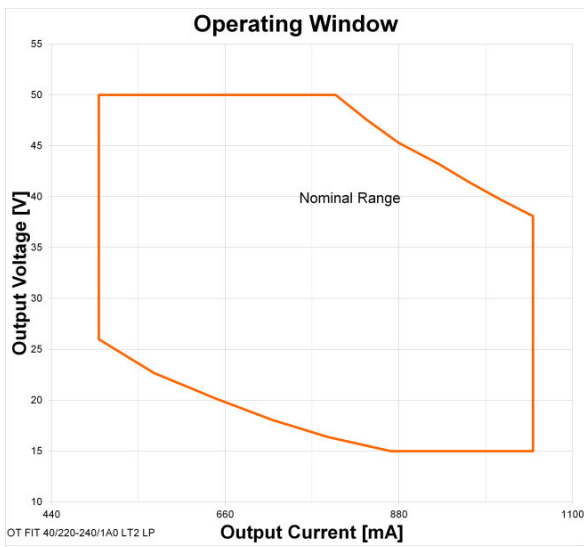

OT FIT 40 Operating Window

Typical Efficiency vs. Load (230 V 50 Hz)

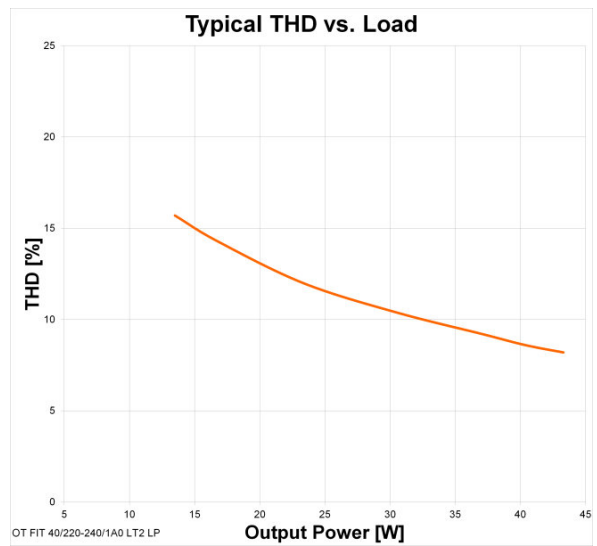
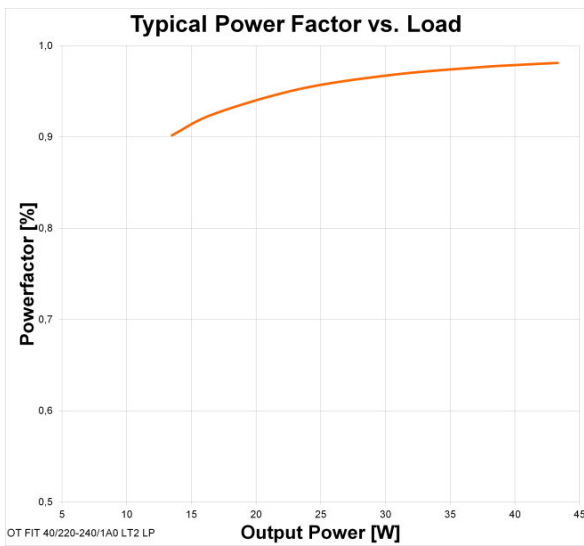

OT FIT 40 Typical Power Factor vs. Load

OT FIT 40 Typical THD vs. Load

## Product datasheet

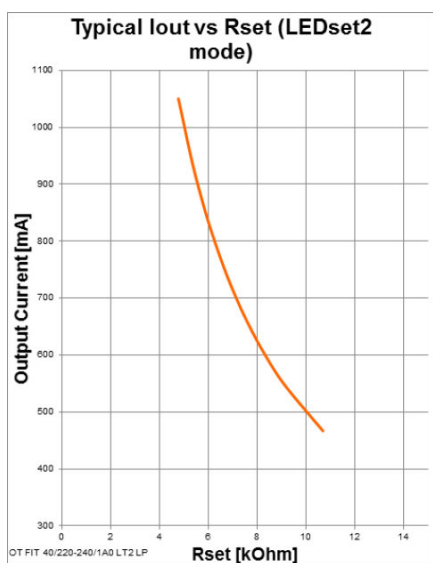

Typical Iout vs Rset (LEDset2 mode)\_new

## Dimensions & weight

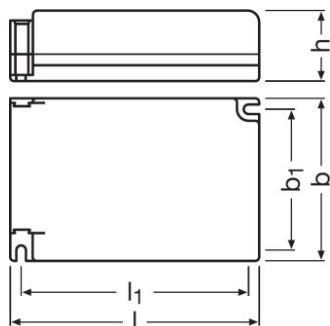

Mounting hole spacing, length	94.0 mm
Mounting hole spacing, width	58.0 mm
Product weight	135.00 g
Cable cross-section, input side	0.5...1.5 mm <sup>2</sup>
Cable cross-section, output side	0.5...1.5 mm <sup>2</sup>
Wire preparation length, input side	9.0...10.0 mm
Wire preparation length, output side	8.0...9.0 mm
Length	103.0 mm
Width	67.0 mm
Height	22.5 mm

## Colors & materials

Casing material	Plastic
-----------------	---------

## Temperatures & operating conditions

Ambient temperature range	-20...+45 °C
Maximum temperature at tc test point	75 °C
Max.housing temperature in case of fault	110 °C
Temperature range at storage	-40...+85 °C
Permitted rel. humidity during operation	5...85 % <sup>1)</sup>

<sup>1)</sup> Maximum 56 days/year at 85 %

## Lifespan

ECG lifetime	50000 / 100000 h <sup>1)</sup>
--------------	--------------------------------

<sup>1)</sup>  $T_c = 75^\circ\text{C}$ , 0.2% / 1,000 h failure rate /  $T_c = 65^\circ\text{C}$ , 0.1% / 1,000 h failure rate

## Capabilities

Dimmable	No
Overheating protection	Automatic reversible
Overload protection	Automatic reversible
Short-circuit protection	Automatic reversible
No-load proof	Yes
Max. cable length to lamp/LED module	2.0 m
Suitable for fixtures with prot. class	I / II
Type of connection, output side	Push terminal
Number of channels	1

## Programming

Programming device	LEDset
--------------------	--------

## Certificates & standards









Approval marks – approval	CE
Standards	Acc. to IEC 61347-1/Acc. to IEC 61347-2-13/Acc. to IEC 62384/Acc. to IEC 61000-3-2/Acc. to IEC 61547/Acc. to EN 55015
Type of protection	IP20

## Logistical data

Commodity code	850440829000
----------------	--------------

## Product datasheet

### Download Data

File	
	User instruction OPTOTRONIC LED Power Supply
	Product Datasheet Datasheet OT FIT 40LT2 LP
	Certificates OT ENEC 40038447 210721
	Certificates CEAG OT FIT 40220-2401A0 LT2 LP
	Certificates INOTEC OT FIT 40220-2401A0 LT2 LP
	Certificates CCC Certificate 2018171002002040
	Certificates CCC Certificate 2018171002002039
	Declarations of conformity OT FIT LT2 LP CE 3520188 021220
	CAD data 3-dim OT FIT-LT2-15-25-40 cable clamp 3Ddrawing
	CAD data 3-dim OT FIT-LT2-15-25-40 housing 3Ddrawing
	CAD data 3-dim OT FIT-LT2-15-25-40 housing with cable clamp 3Ddrawing

### Logistical Data

Product code	Product description	Packaging unit (Pieces/Unit)	Dimensions (length x width x height)	Volume	Gross weight
4052899490734	OT FIT 40/220...240/1A0 LT2 LP	Shipping carton box 20	348 mm x 218 mm x 67 mm	5.08 dm <sup>3</sup>	2862.00 g

The mentioned product code describes the smallest quantity unit which can be ordered. One shipping unit can contain one or more single products. When placing an order, for the quantity please enter single or multiples of a shipping unit.

### Disclaimer

Subject to change without notice. Errors and omission excepted. Always make sure to use the most recent release.