









# Kunststoffschellen im Überblick



## Kunststoffschellen

	Abranyl® AN	Abranyl® ABT	Abranyl® ABM	Multiclip MC	Multiclip UT
Durchmesser Ø (mm)	12-50	14-42	10-42	16-40	16-40
Grundmaterial	Nylon	Nylon	Nylon	Polypropylen	Nylon
Temperaturbereich °C	<b>-10°C bis +90°C</b> (in Spitzen von -25°C bis +110°C)	<b>-10°C bis +90°C</b> (in Spitzen von -25°C bis +110°C)	<b>-10°C bis +90°C</b> (in Spitzen von -25°C bis +110°C)	<b>-20°C bis +100°C</b> (in Spitzen von -30°C bis +120°C)	<b>-10°C bis +90°C</b> (in Spitzen von -25°C bis +110°C)
Zuglast (kg)	<b>60</b>	<b>60</b>	<b>60</b>	<b>10</b>	<b>10</b>
 Europäische Technische Zulassung/Bewertung (ETA)	<b>X</b>	 <small>in Kombination von zugelassenem Zubehör, XHA-Nägeln (22-38 mm) und FORCE ONE</small>	<b>X</b>	<b>X</b>	 <small>in Kombination von zugelassenem Zubehör, XHA-Nägeln (22-38 mm) und FORCE ONE</small>
 Schwarze Schellen: UV-beständig	<b>X</b>	✓	✓	<b>X</b>	<b>X</b>
 Halogenfrei	✓	✓	✓	✓	✓
 RoHS konform	✓	✓	✓	✓	✓
 KIWA Zulassung	✓	✓	✓	<b>X</b>	<b>X</b>
 UL Zertifikat	<b>X</b>	✓	<b>X</b>	<b>X</b>	<b>X</b>
 Patentierte Schelle	<b>X</b>	✓	✓	<b>X</b>	<b>X</b>
Abfederung von Dehnung	✓	✓	✓	<b>X</b>	<b>X</b>
Multi-Durchmesser	✓ 2 Durchmesser pro Größe, außer bei Ø 10, 12, 14	✓ 3 Durchmesser pro Größe	✓ 3 Durchmesser pro Größe	<b>X</b>	<b>X</b>
Schnelle Installation mit:	 Nageldübel NP	 Gasnagler FORCE ONE und FOX	 Tacomax®	 Nageldübel NP	 Gasnagler FORCE ONE und FOX
 Befestigung mit metrischem Gewinde	✓ M6	<b>X</b>	✓ mit Insermax®	<b>X</b>	<b>X</b>
Parallelmontage möglich	<b>X</b>	<b>X</b>	<b>X</b>	✓	✓
Anwendungen	Elektro- und Sanitär	Elektro- und Sanitär	Elektro- und Sanitär	Elektro	Elektro
Seite	271	271	272	273	274

# Schelle Abranyl®

## Vorteile



- Beim Eindrücken des Rohrs schließt die Schelle selbständig; Sie sparen Zeit und Geld
- Vielseitige Installation mit Schrauben, Nageldübel, Tacomax® oder Insermax®
- KIWA zertifiziert; Schelle ist für Warmwasserrohre bis 90 °C einsetzbar
- Hohe Anwendungszuverlässigkeit
- Schwarze Schellen: UV-beständig
- Halogenfrei

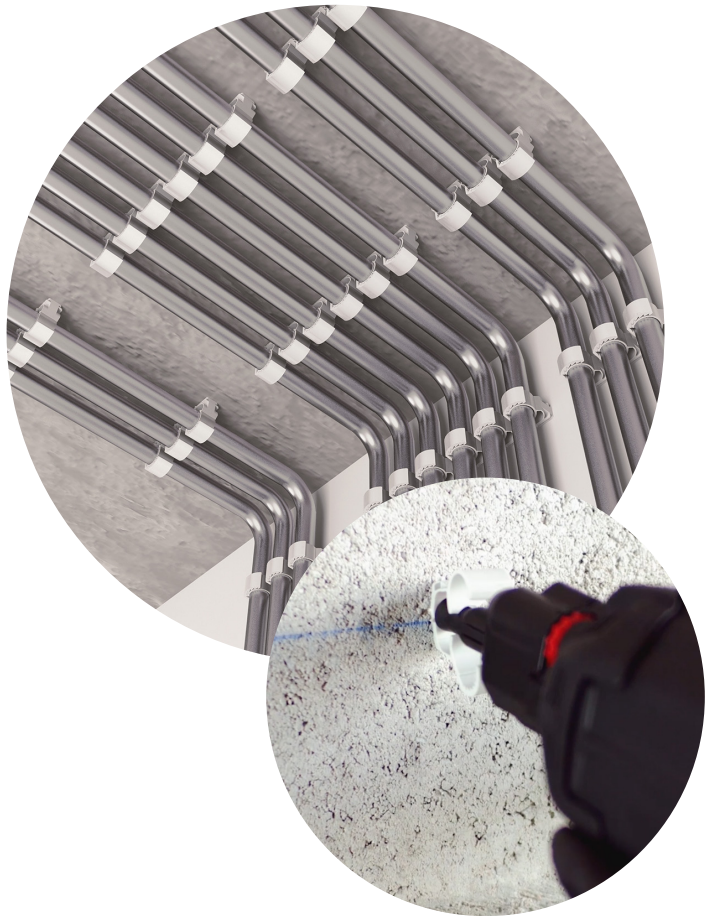

## Zulassungen und Zertifikate



ABT  
in Kombination von zugelassenem  
Zubehör, XHA-Nägeln  
(22-38 mm) und FORCE ONE

## Montage

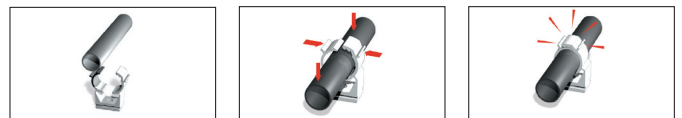

## Installationsmöglichkeiten

Typ	mit Dübel und Schraube <sup>1</sup>	mit Profilen <sup>2</sup>	mit Nageldübel <sup>3</sup>	mit Tacomax®	mit Insermax®	mit Gasnagler FORCE ONE	Hinweis
AN	●	●	●	-	-	-	Millionenfach verkauft und auf dem Markt etabliert
ABM	●	●	○	●	●	-	Beste Schelle für eine Vielzahl an Installationen aufgrund ihrer universellen Einsetzbarkeit
ABT	○	●	-	-	-	●	Bevorzuge Schelle für größere Projekte; Sehr schnelle Installation mit dem Gasnagler FORCE ONE und FOX

● Very suitable      ○ Suitable

<sup>1</sup> Mit Dübel Ø6 z.B. FX 6, MZK 6 etc.

<sup>2</sup> Mit CELO-Profilen z.B. PVC 1000, E2000PG, E2000PB

<sup>3</sup> Mit Nageldübel NP 5x35

## Schelle Abranyl®

### Vorteile Abranyl® AN Classic

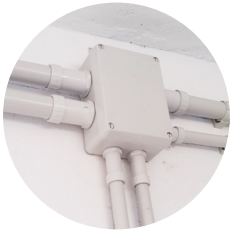

- Multidurchmesser: Eine Schellengröße deckt zwei Rohrdurchmesser ab



#### AN Classic

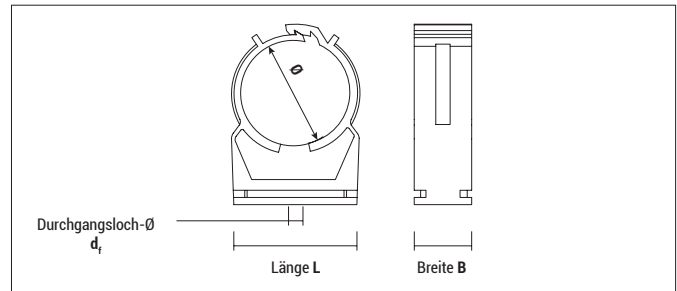

Typ	Ø [mm]	d <sub>f</sub> [mm]	Länge L [mm]	Breite B [mm]
AN 12	11,8	5,0	18,0	13,0
AN 14	13,8	5,0	20,0	14,0
AN 15/16	15,0	5,0	19,5	15,5
AN 18/20	18,5	5,0	24,0	15,5
AN 22/25	22,5	5,0	27,0	15,5
AN 26/28	26,6	5,0	29,0	15,5
AN 30/32	30,5	5,0	34,0	17,0
AN 35/40	34,2	5,0	42,5	18,0
AN 47/50	47,5	5,0	51,0	19,7

Typ	Art.-Nr.			Rohr-Ø				Empfohlener Abstand zwischen den Schellen [m]	€/100 Stück	[Stück]	[Stück]
	grau	schwarz	weiß	metrisch [mm]	Kupfer [mm]	Stahl [Zoll]	Plastik [mm]				
AN 12 <sup>1</sup>	912AN	–	–	–	12	–	–	0,50	–	100	900
AN 14 <sup>1</sup>	914AN	–	–	–	–	1/4"	–	0,50	–	100	900
AN 15/16	915AN	9415AN	9115AN	16	15	–	16	0,50	–	100	900
AN 18/20	918AN	9418AN	9118AN	20	18	3/8"	20	0,60	–	100	900
AN 22/25	922AN	9422AN	9122AN	25	22	1/2"	25	0,75	–	100	600
AN 26/28	926AN	–	9126AN	–	28	3/4"	–	0,75	–	100	600
AN 30/32	930AN	9430AN	9130AN	32	32	–	–	0,85	–	100	–
AN 35/40	935AN	9435AN	–	40	35	1"	40	1,00	–	100	–
AN 47/50	947AN	–	–	50	–	1-1/2"	50	1,10	–	50	–

<sup>1</sup> Nicht zu verwenden in Profilen

### Vorteile Abranyl® ABT



- Empfohlen für die Verwendung mit Gasnaglern
- Multidurchmesser: Eine Schellengröße deckt drei Rohrdurchmesser ab
- Patentierte Schelle



in Kombination von zugelassenem Zubehör: XHA-Nägeln (22-38 mm) und FORCE ONE



#### ABT

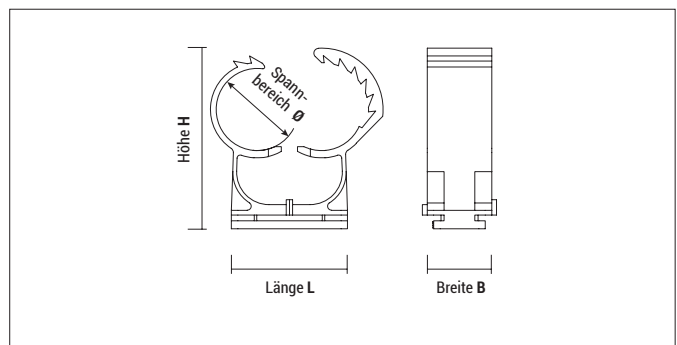

Typ	Spann-bereich Ø [mm]	Länge L [mm]	Höhe H [mm]	Breite B [mm]
ABT 14/18	14-18	24,0	35,6	20
ABT 20/25	20-25	29,0	45,5	20
ABT 26/32	26-32	36,0	53,6	20
ABT 35/42	35-42	45,0	66,4	20

Typ	Art.-Nr.		Art.-Nr.		€/100 Stück	Rohr-Ø				ETA	[Stück]	[Stück]
	Ø	grau	schwarz	weiß		metrisch [mm]	Kupfer [mm]	Stahl [Zoll]	Plastik [mm]			
ABT 14/18	918ABT	–	9418ABT	9118ABT	–	16	14-15-18	3/8"	16	●	100	600
ABT 20/25	925ABT	–	9425ABT	9125ABT	–	20-25	–	1/2"	20-25	●	50	450
ABT 26/32	932ABT	–	9432ABT	9132ABT	–	32	28	3/4"	32	●	50	300
ABT 35/42	942ABT	–	9442ABT	9142ABT	–	40	35-42	1"-1/4"	40-42	●	25	150

Kompatible Gasnagler finden Sie auf Seite 249

## Schelle Abranyl®

### Vorteile Abranyl® ABM "Max"



- Multidurchmesser: Eine Schellengröße deckt drei Rohrdurchmesser ab
- Patentierte Schelle
- Halogenfrei
- Verwendbar mit Schrauben Ø4,5 mm und Dübel Ø6 mm

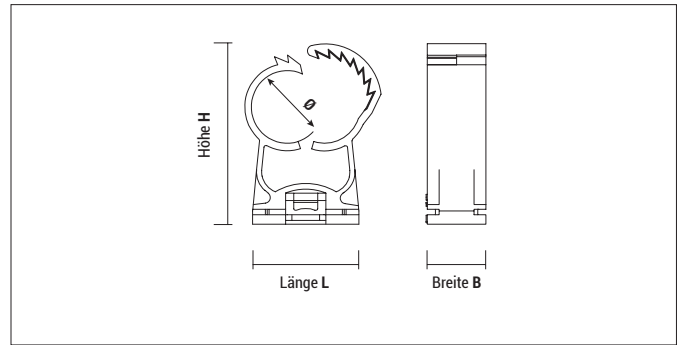

Typ	Ø [mm]	Länge L [mm]	Höhe H [mm]	Breite B [mm]
ABM 10/14	9,8	22,0	32,0	16,0
ABM 14/18	16,5	20,0	35,0	16,0
ABM 20/25	19,5	29,0	48,0	16,0
ABM 25/32	25,5	32,0	52,0	16,0
ABM 35/42	34,4	45,0	66,0	16,0



### ABM "Max"

Typ Ø	Art.-Nr.			Rohr-Ø				€/100 Stück	[Stück]	[Stück]
	grau	schwarz	weiß	metrisch [mm]	Kupfer [mm]	Stahl [Zoll]	Plastik [mm]			
ABM 10/14	914ABM	-	-	-	10-12	1/8"-1/4"	-	100	900	
ABM 14/18	918ABM	9418ABM	9118ABM	16	14-15-18	3/8"	16	100	900	
ABM 20/25	925ABM	9425ABM	9125ABM	20-25	22	1/2"	20-25	50	450	
ABM 25/32	932ABM	9432ABM	9132ABM	32	28	3/4"	32	100	-	
ABM 35/42	942ABM	9442ABM	9142ABM	40	35-42	1"-1/4"	40-42	100	-	

### Montage ABM "Max"



Anwendung mit Tacomax® Ø6

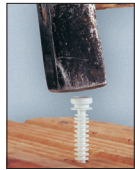

Anwendung mit M6-Adapter Insermax®

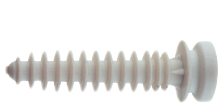
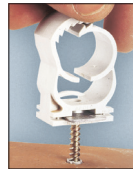

TACOMAX®



INSERMAX®

### Zubehör für Abranyl® ABM "Max"

Typ	Art.-Nr.	Größe [mm]	€/100 Stück	[Stück]	[Stück]
TACOMAX®	9630TMX	6x30		200	1.800
INSERMAX®	96IMX	M6		100	4.000