

- > **Anschluss:**
Ø 4 ... 14 mm
Rohr außen Ø
- > **Sehr kompakte Einheiten**
- > **Einfacher und schneller Aufbau von pneumatischen Systemen**
- > **Sichere Rohrfixierung**

- > **PTFE-freie Dichtvorbeschichtung bei kegelförmigen Gewinden**
- > **Sämtliche geraden Verschraubungen lassen sich durch den integrierten Innensechskant einfach montieren**
- > **O-Ringe aus VMQ freiem NBR**



Technische Merkmale

Betriebsmedium:
Druckluft
(Weitere zugelassene Betriebsmedien auf Anfrage)
Betriebsdruck
Vakuum -18 bar (... 261 psi)
(Abhängig vom eingesetztem Rohr oder Schlauch)

Vakuum:
-750 mm Hg i.e. 98%
Umgebungs/Mediums-temperatur:
-20° ... +80°C (-4° ... +176°F)
Tiefsttemperatur-Ausführung auf Anfrage
Rohr-/ Schlauchgrößen:
4, 5, 6, 8, 10, 12, 14 mm O/D

Schläuche:
PA 11 und 12, PUR sowie andere Schläuche, entsprechend den Toleranzen aus BS5409/1:1976, leichte und normale Beanspruchung, DIN 73378, DIN 74324, NFE 49-100

Material:
Grundkörper : Messing vernickelt
Löse- und Greifring: Messing vernickelt
'O'-ring: NBR VMQ-frei (FPM optional)
Dichtscheibe: (Kunststoff) (zylindrisches Gewinde)
Gewindebeschichtung
Montagehinweise (kegelförmiges Gewinde): PTFE-frei

Montagehinweise

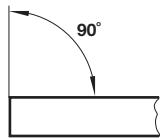

1. Rohrenden rechtwinklig abschneiden und innen sowie außen entgraten

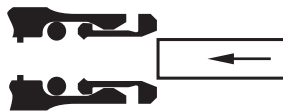

2. Rohrende (Außenoberfläche frei von Beschädigungen) durch den Lösering schieben]



3. Leichten Widerstand vom O-Ring überwinden und bis zum Anschlag eindrücken.

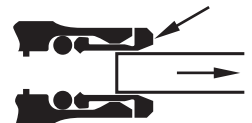

4. Lösering gegen die Armatur drücken und Rohr herausziehen

Einzelteile

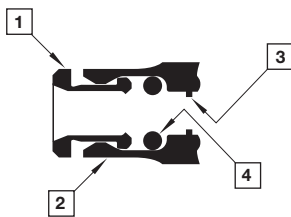

- 1 Löse- und Greifring
- 2 Grundkörper
- 3 Rohranschlag
- 4 O-Ring

Typenschlüssel

10 ★★★★★



Gerade Verbindungen und gerade Ein-, Aufschraubverbindungen

<p>Einsteck-schlauchtülle (Zapfen auf Schlauch) 10019</p>  <p>Seite 3</p>	<p>Gerade Durchgangs-Verbindung (Rohr/Rohr) 10020</p>  <p>Seite 3</p>	<p>Doppel-Steck-nippel 10022</p>  <p>Seite 3</p>	<p>Gerade Reduzier-steckverbindung 10023</p>  <p>Seite 3</p>	<p>Gerade Schottverbin-dung (Rohr/Rohr) 10029</p>  <p>Seite 4</p>	<p>Kombinierte Schottverbin-dung (PUSH-IN) auf Klemmring 10031</p>  <p>Seite 4</p>	<p>Einschraub-Steck-stutzen, kegeliges Gewinde 10115</p>  <p>Seite 4</p>
<p>Einschraub-Steck-stutzen, zylindrisches Gewinde 10215</p>  <p>Seite 4</p>	<p>Gerade Verschrau-bung, kegeliges Gewinde 10125</p>  <p>Seite 5</p>	<p>Gerade Verschrau-bung, zylindrisches Gewinde 10225</p>  <p>Seite 5</p>	<p>Gerade Aufschraub-Ver-schraubung, kegeliges Gewinde (Innengewinde) 10226</p>  <p>Seite 5</p>			

Winkelverbindungen und drehbare Winkel-, Ein- und Aufschraubverschraubungen

<p>Winkelverbindung 10040</p>  <p>Seite 6</p>	<p>Winkel-Steckverbin-dung 10043</p>  <p>Seite 6</p>	<p>Winkel-Schottverbin-dung 10049</p>  <p>Seite 6</p>	<p>Winkelverschrau-bung, kegeliges Gewinde 10145</p>  <p>Seite 6</p>	<p>90° Winkelver-schraubung, dreh-bar, kegeliges Gewinde 10147</p>  <p>Seite 7</p>	<p>90° Winkelver-schraubung, dreh-bar, zyl. Gewinde 10247</p>  <p>Seite 7</p>	<p>Winkelverschraub-ung, lang, drehbar, kegeliges Gewinde 10154</p>  <p>Seite 7</p>
<p>Winkelverschrau-bung, 45°, drehbar, zyl. Gewinde) 10257</p>  <p>Seite 7</p>	<p>Winkel-Schwenkver-schraubung, zyl. Gewinde) 10A51</p>  <p>Seite 8</p>	<p>Drosselrückschlag-ventil (Abluft), Einstellschraube versenkt, zyl. Gewinde 10K51</p>  <p>Seite 8</p>	<p>Drosselrückschlag-ventil (Abluft), (Kunststoff), Einstellschraube versenkt, keg. Gewinde 10TA0</p>  <p>Seite 8</p>	<p>Drosselrückschlag-ventil (Abluft), (Kunststoff), keg. Gewinde 10TA0</p>  <p>Seite 8</p>		

T-Verbindungen und drehbare Einschraub-Verbindungen, Y-Verbindungen und Kreuz-Verbindungen

<p>T-Verbindung (Rohr x 3) 10060</p>  <p>Seite 9</p>	<p>T-Verschraubung, kegeliges Gewinde) 10165</p>  <p>Seite 9</p>	<p>T-Verschraubung, drehbar, kegeliges Gewinde 10167</p>  <p>Seite 9</p>	<p>T-Verschraubung drehbar, zylindrisches Gewinde) 10267</p>  <p>Seite 9</p>	<p>T-Schwenkverschrau-bung, zylindrisches Gewinde 10A71</p>  <p>Seite 10</p>	<p>T-Verschraubung, seitlich, kegeliges Gewinde 10175</p>  <p>Seite 10</p>	<p>T-Verschraubung, drehbar, seitlich, kegeliges Gewinde) 10168</p>  <p>Seite 10</p>
<p>T-Verschraubung, drehbar, seitlich, zylindrisches Gewinde 10268</p>  <p>Seite 10</p>	<p>Kreuzverbindung (Rohr x 4) 10090</p>  <p>Seite 11</p>	<p>Y-Verbindung/ Y-Reduzierverbin-dung (Kunststoff) 10082</p>  <p>Seite 11</p>	<p>Y-Verschraubung (Kunststoff),drehbar, kegeliges Gewinde 10188</p>  <p>Seite 11</p>	<p>Y-Verschraubung, drehbar, (Kunststoff), zylindrisches Gewinde 10288</p>  <p>Seite 11</p>	<p>Mehrfachverteiler (Kunststoff) 100D6</p>  <p>Seite 12</p>	<p>Mehrfachverteiler (Kunststoff), kegeliges Gewinde 101D6</p>  <p>Seite 12</p>

Schwenkverschraubungen und Hohlschrauben

<p>Winkel-Schwenkver-schraubungs-körper 10051</p>  <p>Seite 12</p>	<p>Schwenkver-schraubungs-körper 10071</p>  <p>Seite 12</p>	<p>Hohlschraube, 1-fach (mit Dichtringen) 20A00</p>  <p>Seite 13</p>	<p>Hohlschraube, 2-fach (mit Dichtringen) 20B00</p>  <p>Seite 13</p>	<p>Hohlschraube, 3-fach (mit Dichtringen) 20C00</p>  <p>Seite 13</p>	<p>Aufschraubhohlschraube (mit Dichtringen) 20*00</p>  <p>Seite 13</p>	<p>Drosselschraube mit Rückschlag-ventil (mit Dichtringen) 20*00</p>  <p>Seite 13</p>
--	--	---	---	---	---	--

Zubehör

Schalldämpfer
10011



Seite 14

Stopfen (Acetal)
11004



Seite 14

Technische Daten

Ø A Rohr	Ø S*2)	Ø T*1)	V	Ø K
4	2,8	14	7,5	10
5	3,4	15	10	11
6	4,4	15,5	11	12
8	6	16,5	13	14
10	7,6	21	14,5	17
12	9,6	24,5	18	20,5
14	11,5	24,5	20	21

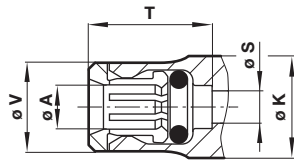

- *1) Die hier und in den jeweiligen Tabellen angegebenen Abmaße beziehen sich auf den Zustand mit eingeschobenem Spannklemmring.
- *2) Die hier angegebenen Bohrungsdurchmesser in Anhängigkeit zu den jeweiligen Schlauchanschlussgrößen zählen für alle Geraden-, Winkel- und T-Verschraubungen (außer bei gesondertem Vermerk)

**Einsteckschlauchtülle (Zapfen auf Schlauch)
10019**

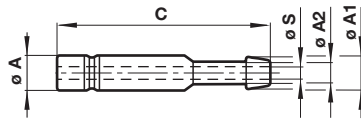

Ø A	Ø A1	Ø A2	C	Ø S	Typ
4	4,5	3	34	1,8	100190403
4	6,5	5	34	2,1	100190405
5	6,5	5	35,5	2,8	100190505
6	6,5	5	36	2,8	100190605
6	8	6,5	36	4	100190606
8	8	6,5	37	4,3	100190806
8	9,5	8	38,5	5,5	100190808
10	8	6,5	41,5	4,3	100191006
10	9,5	8	43	5,5	100191008
10	12	10	44	7,3	100191010
12	9,5	8	46,5	5,5	100191208
12	12	10	46,5	7,3	100191210
12	15	12,5	47,5	9,7	100191212
14	15	12,5	47	9,7	100191412

**Doppel-Stecknippel
10022**

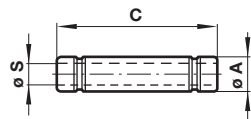

Ø A	C	Ø S	Typ
4	30	2,6	100220400
5	33	3,4	100220500
6	34	4	100220600
8	36	6	100220800
10	45	7,6	100221000
12	52	9,6	100221200
14	52	11,5	100221400

**Gerade Durchgangsverbindung,
Rohr/Rohr 10020**

Abmessungen in mm
Projection/First angle

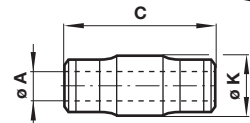

Ø A	C	Ø K	Typ
4	30	10	100200400
5	32	11	100200500
6	33,5	12	100200600
8	35,5	14	100200800
10	44,5	17	100201000
12	51,5	20,5	100201200
14	52,5	21	100201400

**Gerade Reduziersteckverbindung
10023**

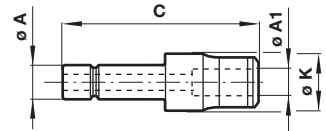

Ø A	Ø A1	C	Ø K	Typ
5	4	33,5	10	100230504
6	4	34	10	100230604
6	5	35	11	100230605
8	4	31	10	100230804
8	5	33	11	100230805
8	6	36,5	12	100230806
10	4	31	12	100231004
10	5	36,5	12	100231005
10	6	37,5	12	100231006
10	8	38	14	100231008
12	4	35	14	100231204
12	5	35	14	100231205
12	6	35	14	100231206
12	8	42	14	100231208
12	10	50	17	100231210
14	6	36,5	16	100231406
14	8	37,5	16	100231408
14	10	46,5	17	100231410
14	12	53,5	20,5	100231412

**Gerade Reduziersteckverbindung
10023**

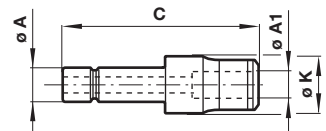

Ø A	Ø A1	C	Ø K	Typ
4	6	35	12	100230406
6	8	37,5	14	100230608

**Gerade Schottverbindung (Rohr/Rohr)
10029**

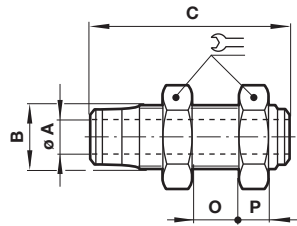

Ø A	B	C	O	P		Typ
4	M10x1,0	30	12	9	14	100290400
5	M12x1,0	32	14	9	17	100290500
6	M14x1,5	35,5	15	10	19	100290600
8	M16x1,5	36,5	16	10	22	100290800
10	M20x1,5	43,5	14	11	27	100291000
12	M24x1,5	50,5	15	11	30	100291200
14	M24x1,5	50,5	15	11	30	100291400

**Kombinierte Schottverbindung
(PUSH-IN) auf Klemmring 10031**

Abmessungen in mm
Projection/First angle

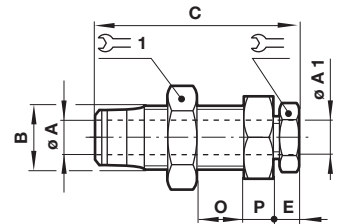

Ø A & Ø A1	B	C	E	O	P			Typ
4	M12x1,0	27	6	9,5	9	8	17	100310404
6	M15x1,0	29,5	7	9,5	10	13	22	100310606
8	M18x1,5	33,5	8	11	10	13	24	100310808
10	M20x1,5	40	8	14,5	11	17	27	100311010
12	M24x1,5	44	9	17,5	11	19	30	100311212
14	M26x1,5	46	11,5	18,5	11	22	32	100311414

**Einschraub-Steckstutzen, kegeliges Gewinde
10115**

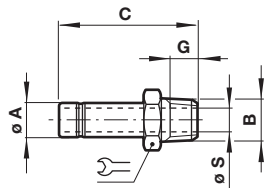

Ø A	B	C	G	Ø S		Typ
4	R1/8	30	7,5	2,1	10	101150418
4	R1/4	33,5	11	2,1	14	101150428
5	R1/8	31	7,5	3,2	11	101150518
5	R1/4	35	11	3,2	14	101150528
6	R1/8	32	7,5	4,1	12	101150618
6	R1/4	35	11	4,1	14	101150628
8	R1/8	33	7,5	7,1	14	101150818
8	R1/4	36,5	11	5,1	14	101150828
8	R3/8	40	12,5	5,1	19	101150838
10	R1/4	40	11	7,7	15	101151028
10	R3/8	45	12,5	7,7	19	101151038
10	R1/2	48	16	8,1	22	101151048
12	R3/8	48	12,5	9,1	19	101151238
12	R1/2	51,5	16	9,1	22	101151248
14	R1/2	51,5	16	11,2	22	101151448

**Einschraub-Steckstutzen, zylindrisches Gewinde
10215**

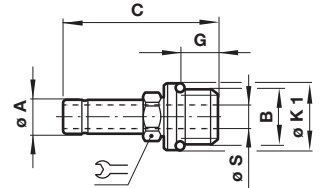

Ø A	B	C	G	Ø K1	Ø S		Typ
4	G1/8	29	5	13,5	2,1	8	102150418
4	G1/4	33	7,5	17,5	2,1	10	102150428
5	G1/8	30,5	5	13,5	3,3	8	102150518
5	G1/4	34	7,5	17,5	3,3	10	102150528
6	G1/8	31	5	13,5	4	8	102150618
6	G1/4	34,5	7,5	17,5	4	10	102150628
8	G1/8	32,5	5	13,5	5	10	102150818
8	G1/4	35,5	7,5	17,5	6	10	102150828
8	G3/8	39	9	21,5	6	13	102150838
10	G1/4	41,5	7,5	17,5	6,5	13	102151028
10	G3/8	43,5	9	21,5	8	13	102151038
10	G1/2	49	12	25,5	8	17	102151048
12	G3/8	48,5	9	21,5	10	17	102151238
12	G1/2	52,5	12	25,5	10	17	102151248
14	G3/8	48,5	9	21,5	10	17	102151438
14	G1/2	52,5	12	25,5	11,5	17	102151448

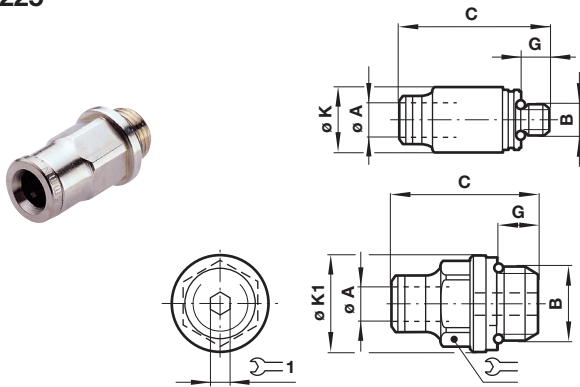
Gerade Verschraubung, zylindrisches Gewinde
10225

Ø A	B	C	G	Ø K	Ø K1	1	1	Typ
4	M3	21	2,5	9	-	-	1,5	102250403
4	M5	21,5	3,5	9	-	-	2,5	102250405
4	G1/8	19	5,5	-	14	10	3	102250418
4	G1/4	21	8	-	18	10	3	102250428
5	M5	23	3,5	10	-	-	2,5	102250505
5	G1/8	23,5	5,5	-	14	10	4	102250518
5	G1/4	22,5	8	-	18	12	4	102250528
6	M5	24	3,5	11	-	-	2,5	102250605
6	G1/8	25	5,5	-	14	11	4	102250618
6	G1/4	23,5	8	-	18	13	4	102250628
8	G1/8	26,5	5,5	-	14	13	5	102250818
8	G1/4	28	8	-	18	14	6	102250828
8	G3/8	24,5	9	-	12	17	6	102250838
8	G1/2	28,5	11	-	26	17	6	102250848
10	G1/8	32	5,5	-	14	17	5	102251018
10	G1/4	33,5	8	-	18	17	7	102251028
10	G3/8	32,5	9	-	22	19	8	102251038
10	G1/2	30,5	11	-	26	19	8	102251048
12	G1/4	36,5	8	-	18	22	7	102251228
12	G3/8	37,5	9	-	22	22	10	102251238
12	G1/2	34,5	11	-	26	22	10	102251248
14	G3/8	37,5	9	-	22	22	10	102251438
14	G1/2	38,5	11	-	26	22	10	102251448

Gerade Verschraubung, kegeliges Gewinde
10125

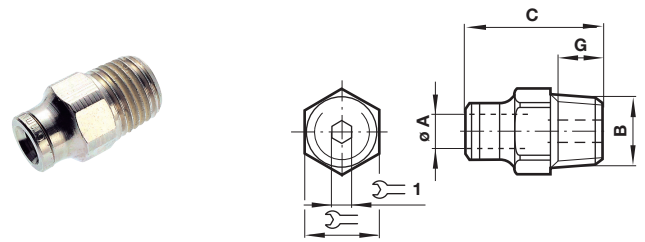
 Abmessungen in mm
 Projection/First angle

Ø A	B	C	G	1	1	Typ
4	R1/8	20,5	10	10	3	101250418
4	R1/4	23	11	14	3	101250428
5	R1/8	22,5	7,5	10	4	101250518
5	R1/4	23	11	14	4	101250528
6	R1/8	23	7,5	11	4	101250618
6	R1/4	25	11	14	4	101250628
8	R1/8	26,5	7,5	13	5	101250818
8	R1/4	28	11	14	6	101250828
8	R3/8	27	12,5	17	6	101250838
8	R1/2	29	16	22	6	101250848
10	R1/8	31,5	7,5	17	5	101251018
10	R1/4	34	11	17	7	101251028
10	R3/8	34	12,5	17	8	101251038
10	R1/2	33,5	16	22	8	101251048
12	R1/4	39	11	22	7	101251228
12	R3/8	39	12,5	22	10	101251238
12	R1/2	40	16	22	10	101251248
14	R3/8	39,5	12,5	22	10	101251438
14	R1/2	40	16	22	10	101251448

Gerade Aufschraubverschraubung, zylindrisches Gewinde (Innengewinde)
10226

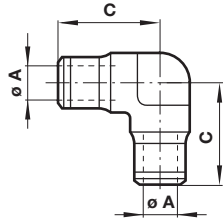

Ø A	B	C	G	1	Typ
4	M5	22,5	5	10	102260405
4	G1/8	24,5	7,5	13	102260418
4	G1/4	29	5	17	102260428
5	M5	23,5	7,5	10	102260505
5	G1/8	25,5	7,5	13	102260518
5	G1/4	29,5	7,5	17	102260528
6	G1/8	26	11	13	102260618
6	G1/4	30,5	11	17	102260628
8	G1/8	27	11	13	102260818
8	G1/4	31,5	11	17	102260828
10	G1/4	36,5	11	17	102261028
10	G3/8	39	11,5	19	102261038
12	G3/8	41	11,5	19	102261238
12	G1/2	44,5	15	24	102261248

**Winkelverbindung
10040**

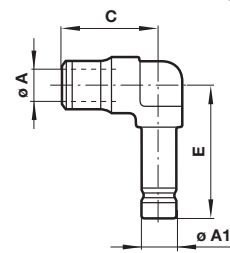

$\varnothing A$	C	Typ
4	17	100400400
5	18,5	100400500
6	19,5	100400600
8	21,5	100400800
10	26,5	100401000
12	31,5	100401200
14	33	100401400

**Winkel-Steckverbindung
10043**





Abmessungen in mm
Projection/First angle

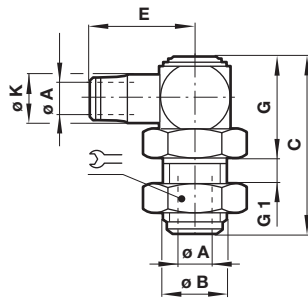

$\varnothing A$	$\varnothing A1$	C	E	Typ
4	4	9,5	25	100430400
6	6	19	27,5	100430600
8	8	21	29,5	100430800
8	5	19,5	30	100430805

**Winkel-Schottverbindung
10049**



$\varnothing A$	$\varnothing B$	C	E	G	G1	$\varnothing K$		Typ
4	M12x1,0	35,5	20,5	21,5	7	10	17	100490400
5	M12x1,0	35,5	21,5	21,5	7	11	17	100490500
6	M14x1,5	40	24	24,5	7	12	19	100490600
8	M16x1,5	45	26,5	30	7	14,5	22	100490800
10	M22x1,5	49	31,5	31	9	17	27	100491000
12	M24x1,5	54	38	32,5	12	20,5	30	100491200
14	M26x1,5	57	38	32,5	15	22,5	32	100491400

**Winkelverschraubung, kegeliges Gewinde
10145**

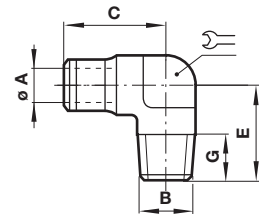

$\varnothing A$	B	C	E	G		Typ
4	R1/8	15	17	7,5	7	101450418
4	R1/4	20	18	11	11	101450428
5	R1/8	15,5	18,5	7,5	7	101450518
5	R1/4	20	20	11	11	101450528
6	R1/8	16	19,5	7,5	8	101450618
6	R1/4	20	20	11	11	101450628
8	R1/8	17	21,5	7,5	11	101450818
8	R1/4	20	21,5	11	11	101450828
8	R3/8	23	22	12,5	13	101450838
8	R1/2	29	24	16	17	101450848
10	R1/8	18,5	26,5	7,5	13	101451018
10	R1/4	21,5	26,5	11	13	101451028
10	R3/8	23	26,5	12,5	13	101451038
10	R1/2	29	28,5	16	17	101451048
12	R1/4	23,5	31,5	11	16	101451228
12	R3/8	25	31,5	12,5	16	101451238
12	R1/2	29	32	16	17	101451248

90o Winkelverschraubung, drehbar, kegeliges Gewinde 10147

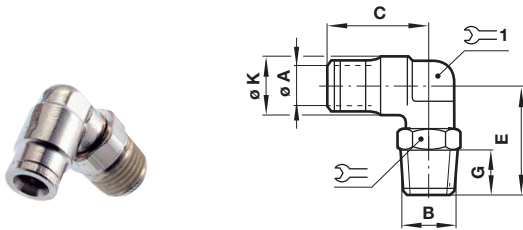

Ø A	B	C	E	G	Ø K			Typ
4	R1/8	17	20,5	7,5	10	10	7	101470418
4	R1/4	17	24	11	10	14	7	101470428
5	R1/8	18,5	21	7,5	11	11	9	101470518
5	R1/4	18,5	24,5	11	11	14	9	101470528
6	R1/8	19,5	21,5	7,5	12	11	9	101470618
6	R1/4	19,5	25	11	12	14	9	101470628
6	R3/8	20	27,5	12,5	12	17	8	101470638
8	R1/8	21,5	23	7,5	14,5	14	11	101470818
8	R1/4	21,5	26	11	14,5	14	11	101470828
8	R3/8	22	30,5	12,5	14,5	17	13	101470838
8	R1/2	22	34,5	16	14,5	22	13	101470848
10	R1/8	26,5	25,5	7,5	17	14	13	101471018
10	R1/4	26,5	29	11	17	17	13	101471028
10	R3/8	26,5	30,5	12,5	17	17	13	101471038
10	R1/2	26,5	34,5	16	17	22	13	101471048
12	R1/4	31,5	32	11	20,5	19	16	101471228
12	R3/8	31,5	34	12,5	20,5	22	16	101471238
12	R1/2	31,5	38	16	20,5	22	16	101471248
14	R3/8	30,5	33	12,5	21,5	22	17	101471438
14	R1/2	31,5	37	16	21,5	22	17	101471448

90o Winkelverschraubung, drehbar, zylindrisches Gewinde 10247

Abmessungen in mm
Projection/First angle

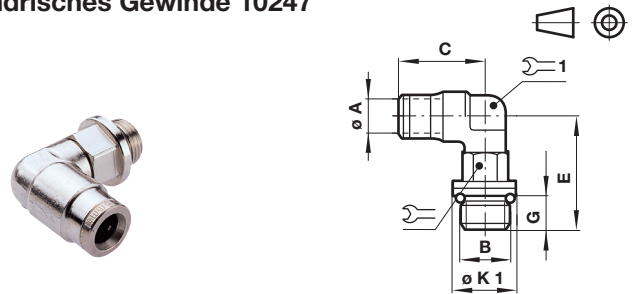

Ø A	B	C	E	G	Ø K1			Typ
4	M3	17	17,5	3,5	-	8	7	102470403
4	M5	17	21,5	4	8	8	7	102470405
4	G1/8	17	22	5,5	14	11	7	102470418
4	G1/4	17	25,5	8	18	11	7	102470428
5	M5	18,5	20	4	8	8	9	102470505
5	G1/8	18,5	22,5	5,5	14	11	9	102470518
5	G1/4	18,5	26	8	18	11	9	102470528
6	M5	19,5	20,5	4	8	8	9	102470605
6	G1/8	19,5	23	5,5	14	11	9	102470618
6	G1/4	19,5	26,5	8	18	11	9	102470628
8	G1/8	21,5	24	5,5	14	13	11	102470818
8	G1/4	21,5	29	8	18	17	11	102470828
8	G3/8	22	33,5	9	22	19	13	102470838
8	G1/2	22	39,5	11	26	19	13	102470848
10	G1/8	26,5	26,5	5,5	14	17	13	102471018
10	G1/4	26,5	31,5	8	18	17	13	102471028
10	G3/8	26,5	33,5	9	22	19	13	102471038
10	G1/2	26,5	39,5	11	26	19	13	102471048
12	G1/4	31,5	35,5	8	18	19	16	102471228
12	G3/8	31,5	37	9	22	19	16	102471238
12	G1/2	31,5	43	11	26	19	16	102471248
14	G3/8	30,5	36	9	22	19	17	102471438
14	G1/2	31,5	39	11	26	24	17	102471448

Winkelverschraubung, lang, drehbar, kegeliges Gewinde 10154

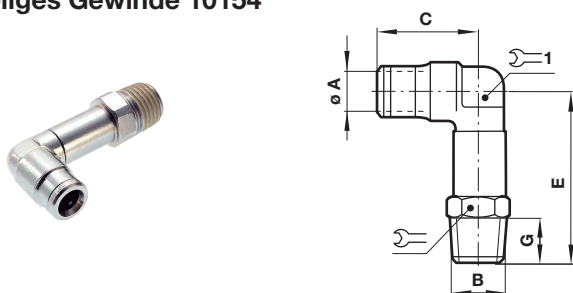

Ø A	B	C	E	G			Typ
4	R1/8	17	34	7,5	10	7	101540418
4	R1/4	17	40	11	14	7	101540428
6	R1/8	19,5	36,5	7,5	11	9	101540618
6	R1/4	19,5	41	11	14	9	101540628
8	R1/8	21,5	40,5	7,5	14	11	101540818
8	R1/4	21,5	44,5	11	14	11	101540828
8	R3/8	22	51,5	12,5	17	13	101540838
10	R3/8	26,5	51,5	12,5	17	13	101541038

Winkelverschraubung, 45°, drehbar, zylindrisches Gewinde 10257

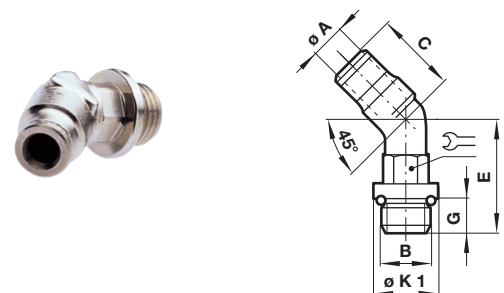

Ø A	B	C	E	G	Ø K1		Typ
6	G1/8	17,5	19,5	5	14	11	102570618
6	G1/4	17,5	23	7,5	18	11	102570628
8	G1/8	19,5	20,5	5	14	11	102570818
8	G1/4	19,5	26	7,5	18	17	102570828

**Winkel-Schwenkverschraubung,
zylindrisches Gewinde
10A51**

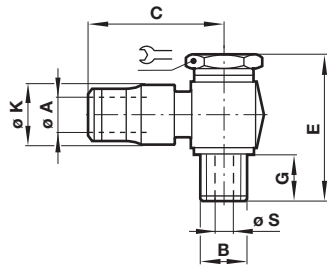

Ø A	B	C	E	G	Ø K	Ø S	↷	Typ
4	M5	18,5	22	4	9,5	2,5	8	10A510405
4	G1/8	20,5	30	6	11	5	14	10A510418
5	M5	20	22	4	11	2,5	8	10A510505
5	G1/8	21,5	30	6	11,5	5	14	10A510518
6	G1/8	23,5	30	6	12,5	5	14	10A510618
6	G1/4	24	34	7,5	13	8,5	17	10A510628
8	G1/8	23,5	30	6	14	5	14	10A510818
8	G1/4	24,5	34	7,5	14	8,5	17	10A510828
8	G3/8	26,5	41	9	16,5	10	22	10A510838
10	G1/4	30	34	7,5	16	8,5	17	10A511028
10	G3/8	31	41	9	17	10	22	10A511038

**Drosselrückschlagventil (Abluft),
Einstellschraube versenkt,
zylindrisches Gewinde 10K51**

Abmessungen in mm
Projection/First angle

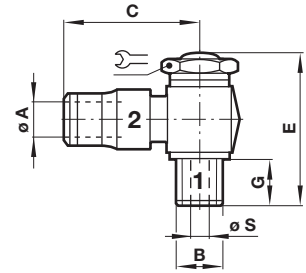

Ø A	B	C	E	G	Ø S	↷	Typ
4	M5	18,5	27	4,5	2,5	8	10K510405
4	G1/8	20,5	34	6	5	14	10K510418
5	M5	20	27	4,5	2,5	8	10K510505
5	G1/8	21,5	34	6	5	14	10K510518
6	M5	22	27	4,5	2,5	8	10K510605
6	G1/8	23,5	34	6	5	14	10K510618
6	G1/4	24	36,5	6	8,5	17	10K510628
8	G1/8	23,5	34	6	5	14	10K510818
8	G1/4	24,5	36,5	6	8,5	17	10K510828
8	G3/8	26,5	51,5	10	10	22	10K510838
10	G1/4	30	36,5	6	8,5	17	10K511028
10	G3/8	31	51,5	10	10	22	10K511038
12	G3/8	33	51,5	10	10	22	10K511238
12	G1/2	38	57,5	10	10	27	10K511248

**Drosselrückschlagventil (Abluft), (Kunststoff)
Einstellschraube versenkt, kegeliges Gewinde
10T00**

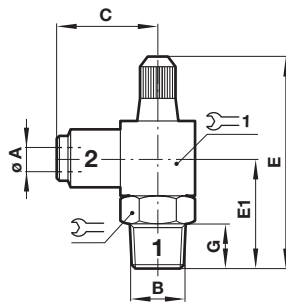

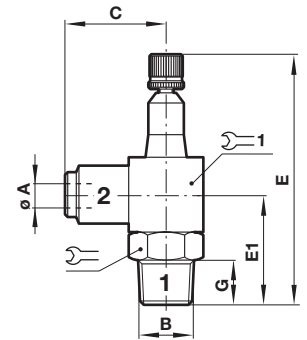

Ø A	B	C	E/E1	G	↷	↷ 1	Typ
4	R1/8	22	42/22,5	9,5	14	16	10T000418
6	R1/8	23	42/22,5	9,5	14	16	10T000618
6	R1/4	25,5	54/29,5	13,5	17	20	10T000628
8	R1/8	24,5	42/22,5	9,5	14	16	10T000818
8	R1/4	27	54/29,5	13,5	17	20	10T000828
8	R3/8	28	64/33	14,5	19	22	10T000838
10	R1/4	31,5	54/29,5	13,5	17	20	10T001028
10	R3/8	32,5	64/33	14,5	19	22	10T001038
12	R1/2	38	72/41,5	16	22	28	10T001248

**Drosselrückschlagventil (Abluft), (Kunststoff)
kegeliges Gewinde
10TA0**



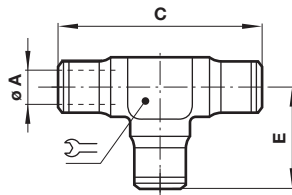

Ø A	B	C	E/E1	G	↷	↷ 1	Typ
4	R1/8	22	53/22,5	9,5	14	16	10TA00418
6	R1/8	23	53/22,5	9,5	14	16	10TA00618
6	R1/4	25,5	67/29,5	13,5	17	20	10TA00628
8	R1/4	27	67/29,5	14,5	17	20	10TA00828
8	R3/8	28	78/33	14,5	19	22	10TA00838
10	R1/4	31,5	67/29,5	13,5	17	20	10TA01028
10	R3/8	32,5	78/33	14,5	19	22	10TA01038
12	R1/2	38	90/41,5	16	22	28	10TA01248

T-Verbindung (Rohr x 3)
10060

Ø A	C	E		Typ
4	34	17	7	100600400
5	37	18,5	7	100600500
6	39	19,5	8	100600600
8	42,5	21,5	11	100600800
10	53,5	26,5	13	100601000
12	63,5	31,5	16	100601200
14	66,5	33	17	100601400

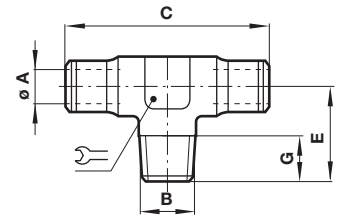
T-Verschraubung, kegeliges Gewinde
10165

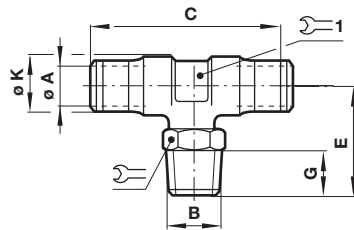

 Abmessungen in mm
 Projection/First angle

Ø A	B	C	E	G		Typ
4	R1/8	34	15	7,5	7	101650418
5	R1/8	37	15,5	7,5	7	101650518
5	R1/4	40	20	11	11	101650528
6	R1/8	39	16	7,5	8	101650618
6	R1/4	40	20	11	11	101650628
8	R1/8	42,5	17	7,5	11	101650818
8	R1/4	42,5	20	11	11	101650828
8	R3/8	44	23,5	12,5	13	101650838
10	R1/4	53,5	21,5	11	13	101651028
10	R3/8	53,5	23,5	12,5	13	101651038
12	R1/4	63,5	23,5	11	16	101651228
12	R3/8	63	25	12,5	16	101651238

T-Verschraubung, drehbar, kegeliges Gewinde
10167

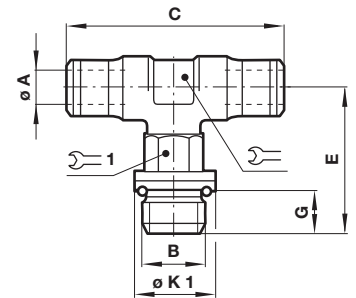

Ø A	B	C	E	G	Ø K			Typ
4	R1/8	34	21,5	7,5	10	10	7	101670418
4	R1/4	34	24	11	10	14	7	101670428
5	R1/8	37	22	7,5	11	11	9	101670518
5	R1/4	37	24,5	11	11	14	9	101670528
6	R1/8	39	22,5	7,5	12	11	9	101670618
6	R1/4	39	25	11	12	14	9	101670628
8	R1/8	42,5	24	7,5	14,5	14	11	101670818
8	R1/4	42,5	26	11	14,5	14	11	101670828
8	R3/8	43,5	30,5	12,5	14,5	17	13	101670838
10	R1/4	53,5	29	11	17	17	13	101671028
10	R3/8	53,5	30,5	12,5	17	17	13	101671038
10	R1/2	53,5	34,5	16	17	22	13	101671048
12	R1/4	63,5	32	11	20,5	19	16	101671228
12	R3/8	63,5	34	12,5	20,5	22	16	101671238
12	R1/2	63,5	38	16	20,5	22	16	101671248
14	R3/8	61,5	33	12,5	22,5	22	17	101671438
14	R1/2	63,5	37	16	22,5	22	17	101671448

T-Verschraubung drehbar, zylindrisches Gewinde
10267

Ø A	B	C	E	G	Ø K 1			Typ
4	M3	34	16	3,5	-	7	8	102670403
4	M5	34	19,5	4	8	7	8	102670405
4	G1/8	34	22	5,5	14	7	11	102670418
5	M5	37	20	4	8	9	8	102670505
5	G1/8	37	22	5,5	14	9	11	102670518
5	G1/4	37	26	8	18	9	11	102670528
6	M5	39	20,5	4	8	9	8	102670605
6	G1/8	39	23	5,5	14	9	11	102670618
6	G1/4	39	26,5	8	18	9	11	102670628
8	G1/8	42,5	23,5	5,5	14	11	13	102670818
8	G1/4	42,5	29	8	18	11	17	102670828
8	G3/8	43,5	22	9	22	13	19	102670838
10	G1/4	53,5	31,5	8	18	13	17	102671028
10	G3/8	53,5	33,5	9	22	13	19	102671038
12	G1/4	63,5	35,5	8	18	16	19	102671228
12	G3/8	63,5	37	9	22	16	19	102671238
14	G1/2	63,5	39	11	26	17	24	102671448

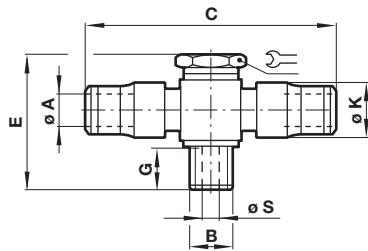
T-Schwenkverschraubung, zylindrisches Gewinde 10A71



Ø A	B	C	E	G	Ø K	Ø S		Typ
4	M5	37,5	22	4	9,5	2,5	8	10A710405
4	G1/8	41	30	6	11	5	14	10A710418
5	M5	40,5	22	4	11	2,5	8	10A710505
5	G1/8	43,5	30	6	11,5	5	14	10A710518
6	M5	41,5	22	4	11,5	2,5	8	10A710605
6	G1/8	47,5	30	6	12,5	5	14	10A710618
6	G1/4	48,5	34	7,5	13	8,5	17	10A710628
8	G1/8	47,5	30	6	14	5	14	10A710818
8	G1/4	49,5	34	7,5	14	8,5	17	10A710828

T-Verschraubung, seitlich, kegeliges Gewinde 10175

Abmessungen in mm
Projection/First angle

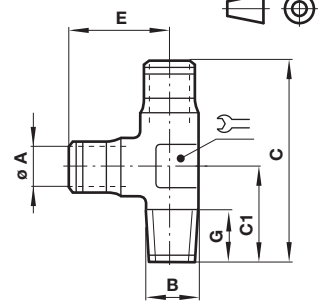

Ø A	B	C	C1	E	G		Typ
4	R1/8	32	15	17	7,5	7	101750418
5	R1/8	34	15,5	18,5	7,5	7	101750518
5	R1/4	40	20	20	11	11	101750528
6	R1/8	35,5	16	19,5	7,5	8	101750618
6	R1/4	40	20	20	11	11	101750628
8	R1/8	38	17	21,5	7,5	11	101750818
8	R1/4	41,5	20	21,5	11	11	101750828
8	R3/8	45,5	23,5	22	12,5	13	101750838
10	R1/4	48,5	21,5	26,5	11	13	101751028
10	R3/8	50	23,5	26,5	12,5	13	101751038
12	R1/4	55	23,5	31,5	11	16	101751228
12	R3/8	56,5	25	31,5	12,5	16	101751238

T-Verschraubung, drehbar, seitlich, kegeliges Gewinde 10168

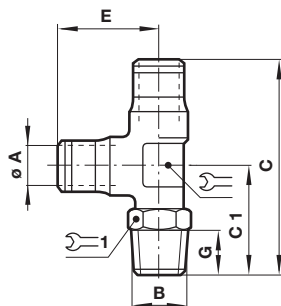

Ø A	B	C	C1	E	G		 1	Typ
4	R1/8	38,5	20,5	17	7,5	7	10	101680418
4	R1/4	41	24	17	11	7	14	101680428
5	R1/8	40,5	22	18,5	7,5	9	11	101680518
5	R1/4	43	24,5	18,5	11	9	14	101680528
6	R1/8	42	22,5	19,5	7,5	9	11	101680618
6	R1/4	44,5	25	19,5	11	9	14	101680628
8	R1/8	45	24	21,5	7,5	11	14	101680818
8	R1/4	47,5	26	21,5	11	11	14	101680828
8	R3/8	52,5	30,5	22	12,5	13	17	101680838
10	R1/4	55,5	29	26,5	11	13	17	101681028
10	R3/8	57	30,5	26,5	12,5	13	17	101681038
12	R1/4	63,5	32	31,5	11	16	19	101681228
12	R3/8	66	34	31,5	12,5	16	22	101681238
12	R1/2	70	38	31,5	16	16	22	101681248
14	R3/8	66,5	33	33	12,5	17	22	101681438
14	R1/2	70	37	33	16	17	22	101681448

T-Verschraubung, drehbar, seitlich, zylindrisches Gewinde 10268

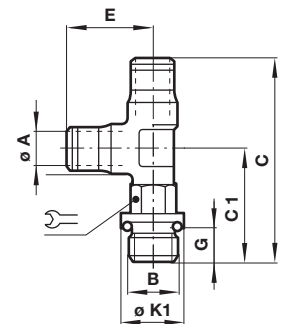

Ø A	B	C	C1	E	G	Ø K1		Typ
4	M3	34	17	17	3,5	-	8	102680403
4	M5	36,5	19,5	17	4	8	8	102680405
4	G1/8	38,5	22	17	5,5	14	11	102680418
5	M5	39	20	18,5	4	8	8	102680505
5	G1/8	40,5	22,5	18,5	5,5	14	11	102680518
5	G1/4	44,5	26	18,5	8	18	11	102680528
6	G1/8	42,5	23	19,5	5,5	14	11	102680618
6	G1/4	46	26,5	19,5	8	18	11	102680628
8	G1/8	45	24	21,5	5,5	14	13	102680818
8	G1/4	50,5	29	21,5	8	18	17	102680828
8	G3/8	55	33	21,5	9	22	19	102680838
10	G1/4	58,5	31,5	26,5	8	18	17	102681028
10	G3/8	60	33,5	26,5	9	22	19	102681038
12	G1/4	67	35,5	31,5	8	18	19	102681228
12	G3/8	68,5	37	31,5	9	22	19	102681238
14	G3/8	69	36	33	9	22	19	102681438
14	G1/2	72,5	39	33	11	26	24	102681448

**Y-Verbindung/ Y-Reduzierverbindung
10082**

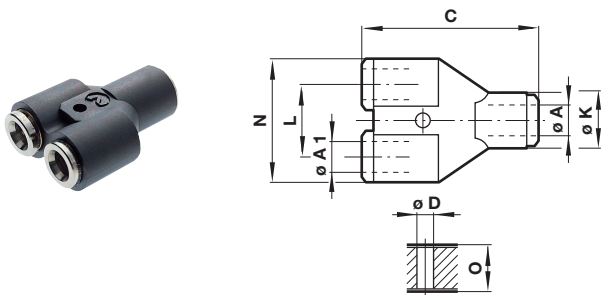

Ø A	Ø A1	C	Ø D	L	N	Ø K	O	Typ
4	4	34	3	11	22	11	10,5	100820400
6	6	38,5	3	14	27	13	12,5	100820600
6	4	38	3	14	27	13	12,5	100820604
8	8	40,5	3	16	31	15	13,5	100820800
8	6	40,5	3	16	31	15	13,5	100820806
10	10	49,5	4	20,5	42	20	15	100821000
10	8	49,5	4	20,5	42	20	15	100821008

**Y-Verschraubung (Kunststoff),
drehbar, kegeliges Gewinde 10188**

Abmessungen in mm
Projection/First angle

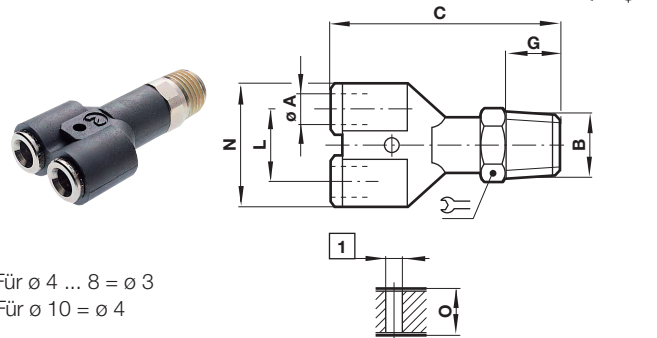

1 Für $\varnothing 4 \dots 8 = \varnothing 3$
Für $\varnothing 10 = \varnothing 4$

Ø A	B	C	G	L	N	O	Symbol	Typ
4	R1/8	43,5	7,5	11	22,5	10,5	10	101880418
6	R1/8	48	7,5	14	28	12,5	11	101880618
8	R1/8	51	7,5	16	32	13,5	14	101880818
8	R1/4	54,5	11	16	32	13,5	11	101880828
10	R3/8	67	12,5	22	42,5	15	19	101881038
10	R1/2	70	16	22	42,5	15	22	101881048

**Y-Verschraubung, drehbar,
zylindrisches Gewinde 10288**

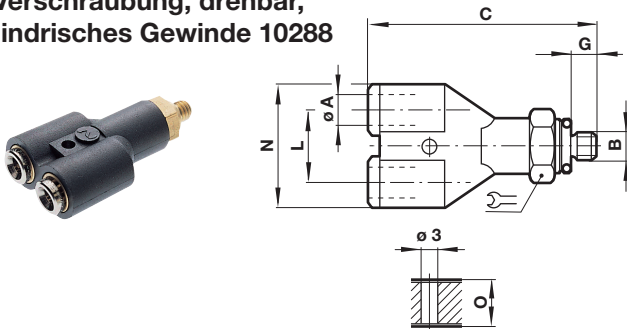

Ø A	B	C	G	L	N	O	Symbol	Typ
4	M5	42,5	4	11	22,5	10,5	10	102880405
6	M5	47	4	14	28	12,5	11	102880605

**Kreuzverbindung (Rohr x 4)
10090**

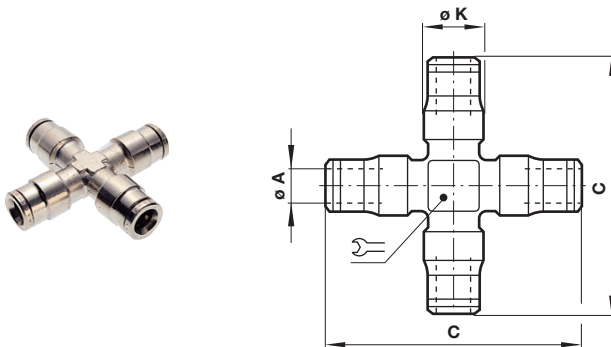

Ø A	C	Ø K	Symbol	Typ
4	42	10,5	10	100900400
5	45,5	11	10	100900500
6	47,5	12	10	100900600
8	57,5	14,5	13	100900800
10	68,5	17	13	100901000

Mehrfachverteiler (Kunststoff)
100D6

Abmessungen in mm
Projection/First angle

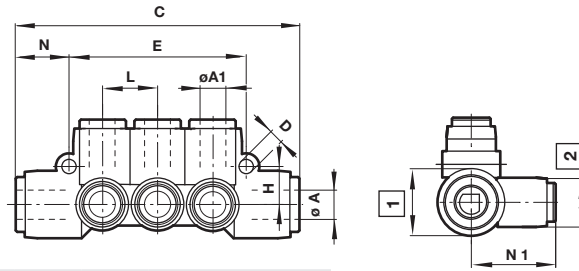

Ø A/Ø A1	C	Ø D	E	H	L	N	N1	Typ
8/4	68	3,4	42	9	13	12,5	20	100D60804
8/6	68	3,4	42	9	13	12,5	20	100D60806
10/6	83	3,4	48	10,5	15	17	22,5	100D61006
10/8	83	3,4	48	10,5	15	17	22,5	100D61008

Mehrfachverteiler (Kunststoff)
100D6

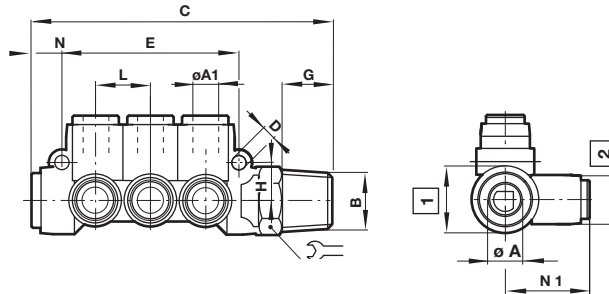

- 1 ø 8 = ø 16
ø 10 = ø 20
- 2 ø 8 = ø 14
ø 10 = ø 16

Ø A	Ø A1	B	C	Ø D	E	G	H	L	N	N1		Typ
8	4	R1/4	83	3,4	42	11	9	13	12,5	20	17	101D60428
8	4	R3/8	85	3,4	42	12,5	9	13	12,5	20	19	101D60438
8	6	R1/4	83	3,4	42	11	9	13	12,5	20	17	101D60628
8	6	R3/8	85	3,4	42	12,5	9	13	12,5	20	19	101D60638
10	8	R3/8	100	3,4	48	12,5	10,5	15	17	22,5	19	101D60838
10	8	R1/2	104	3,4	48	16	10,5	15	17	22,5	22	101D60848

Winkel-Schwenkverschraubungskörper
10051

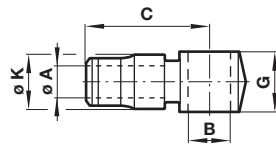

Ø A	B für Gewinde	C	G	Ø K	Typ
4	M5	18,5	12,5	9,5	100510405
4	G1/8	20,5	14	11	100510418
5	M5	20	12,5	11	100510505
5	G1/8	21,5	14	11,5	100510518
6	M5	22	12,5	12,5	100510605
6	G1/8	23,5	14	12,5	100510618
6	G1/4	24	16	13	100510628
8	G1/8	23,5	14	14	100510818
8	G1/4	24,5	16	14	100510828
8	G3/8	26,5	20,5	16,5	100510838
10	G1/4	30	16	16	100511028
10	G3/8	31	20,5	17	100511038
12	G3/8	33	20,5	17,5	100511238
12	G1/2	38	22	17,5	100511248

Schwenkverschraubungskörper
10071

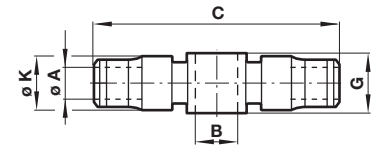

Ø A	B für Gewinde	C	G	Ø K	Typ
4	M5	37,5	12,5	9,5	100710405
4	G1/8	41	14	11	100710418
5	M5	40	12,5	11	100710505
5	R1/8	43	14	11,5	100710518
6	M5	41,5	12,5	11,5	100710605
6	G1/8	47,5	14	12,5	100710618
6	G1/4	48,5	16	13	100710628
8	G1/8	47,5	14	14	100710818
8	G1/4	49,5	16	14	100710828

Hohlschraube (mit Dichtringen)
20A00, 20B00, 20C00



B	C	Ø S	Ausführung		Typ
M5	22	2,5	einfach	8	20A000005
G1/8	29	5	einfach	14	20A000018
G1/4	33	8,5	einfach	17	20A000028
G3/8	41	10	einfach	22	20A000038
G1/2	49	11,5	einfach	27	20A000048
M5	34,5	2,5	zweifach	8	20B000005
G1/8	46,5	5	zweifach	14	20B000018
G1/4	52,5	8,5	zweifach	17	20B000028
G3/8	64	10	zweifach	22	20B000038
G1/2	72,5	11,5	zweifach	27	20B000048
G1/8	63	5	dreifach	14	20C000018
G1/4	71,5	8,5	dreifach	17	20C000028
G3/8	87	10	dreifach	22	20C000038

Aufschraubhohlschraube
(mit Dichtringen)
20*00

Abmessungen in mm
Projection/First angle

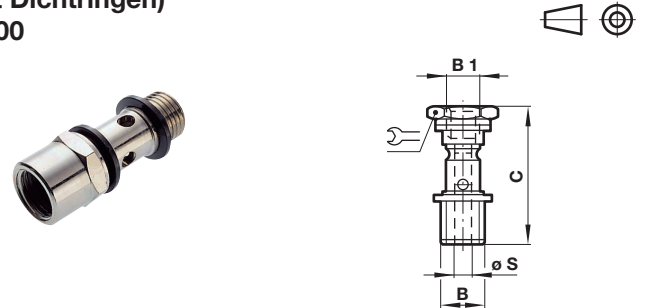

B	B1	C	ØS		Typ
M5	M5	25,5	2,5	8	20D000505
M5	G1/4	34	8,5	17	20D000528
M5	G3/8	41	10	22	20D000538
G1/8	G1/8	36	5	14	20E001818
G1/8	G1/4	35,5	6	17	20E001828
G1/8	G3/8	41	10	22	20E001838
G1/4	G1/4	45	8,5	17	20F002828
G3/8	G3/8	52	10	22	20G003838

Drosselschraube mit Rückschlagventil (Abluft)
(mit Dichtringen)
20K00



B	C	Betriebsdruck		Typ
M5	27,5	10 bar	8	20K000005
G1/8	34	10 bar	14	20K000018
G1/4	36,5	10 bar	17	20K000028
G3/8	51,5	10 bar	22	20K000038
G1/2	57	10 bar	27	20K000048

Drosselschraube mit Rückschlagventil (Zuluft)
(mit Dichtringen)
20L00



B	C	Betriebsdruck		Typ
M5	27,5	10 bar	8	20L000005
G1/8	34	10 bar	14	20L000018
G1/4	36,5	10 bar	17	20L000028
G3/8	51,5	10 bar	22	20L000038
G1/2	57	10 bar	27	20L000048

Drosselschraube (Bidirektional)
(mit Dichtringen)
20M00



B	C	Betriebsdruck		Typ
M5	27,3	10 bar	8	20M000005
G1/8	34	10 bar	14	20M000018
G1/4	36,5	10 bar	17	20M000028
G3/8	51,5	10 bar	22	20M000038
G1/2	57	10 bar	27	20M000048

Schalldämpfer 10011

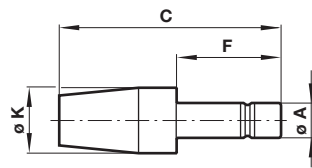

Ø A	C	F	Ø K	Typ
4	31,5	16,5	11	100110400
6	33,5	18,5	11	100110600
8	40,5	19,5	13	100110800
10	53,5	24	19	100111000
12	57	27,5	19	100111200

Stopfen (Acetal) 11004

Abmessungen in mm
Projection/First angle

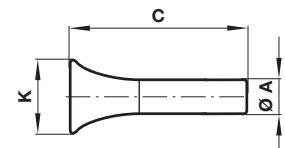

Ø A	C	Ø K	Typ
4	26,5	9,5	110040400
5	28	10,5	110040500
6	28,5	11,5	110040600
8	29,5	12,5	110040800
10	34	15,5	110041000
12	37,5	16,5	110041200
14	37,5	19,5	110041400

Sicherheitshinweise

Diese Produkte sind ausschließlich in Druckluftsystemen zu verwenden. Sie sind dort einzusetzen, wo die unter »**Technische Merkmale/-Daten**« aufgeführten Werte nicht überschritten werden.

Berücksichtigen Sie bitte die entsprechende Katalogseite. Vor dem Einsatz der Produkte bei nicht industriellen Anwendungen, in lebenserhaltenden- oder anderen Systemen, die nicht in den veröffentlichten Anleitungsunterlagen enthalten sind, wenden Sie sich bitte direkt an IMI Precision Engineering, Norgren GmbH.

systemen verwendete Komponenten auf verschiedene Arten versagen. Systemauslegern wird dringend empfohlen, die Störungsarten aller in Pneumatiksystemen verwendeten Komponententeile zu berücksichtigen und ausreichende Sicherheitsvorkehrungen zu treffen, um Verletzungen von Personen sowie Beschädigungen der Geräte im Falle einer solchen Störung zu verhindern. Systemausleger sind verpflichtet, Sicherheitshinweise für den Endbenutzer im Betriebshandbuch zu vermerken, wenn der Störungschutz nicht ausreichend gewährleistet ist.