



Figure can vary

**Part no.: 53800301**  
**RSL420P-M/CU400P-3M12**  
**Safety laser scanner**



## Contents

- . Technical data
- . Dimensioned drawings
- . Electrical connection
- . Operation and display
- . Notes
- . Accessories

## Technical data

<b>Basic data</b>	
Series	RSL 400
Application	Mobile danger zone guarding Mobile side guarding Stationary access guarding Stationary danger zone guarding
<b>Functions</b>	
Functions	PROFIsafe Resolution, selectable
<b>Characteristic parameters</b>	
Type	3 , IEC/EN 61496
SIL	2 , IEC 61508
SILCL	2 , IEC/EN 62061
Performance Level (PL)	d , EN ISO 13849-1
PFH <sub>D</sub>	9E-08 per hour
Mission time T <sub>M</sub>	20 years , EN ISO 13849-1
Category	3 , EN ISO 13849
<b>Protective field data</b>	
Scanning angle	270 °
Minimum adjustable range	50 mm
Number of field pairs, reversible	10
Number of protective functions	1 Piece(s)
Number of independent sensor configurations	1
Diffuse reflection, min.	1.8 %
Operating range	0 ... 4.5 m
<b>Warning field data</b>	
Number of field pairs	10
Operating range	0 ... 20 m
Object size	150 mm x 150 mm
Diffuse reflection, min.	10 %
<b>Optical data</b>	
Light source	Laser , Infrared
Laser light wavelength	905 nm
Laser class	1 , IEC/EN 60825-1:2007
Transmitted-signal shape	Pulsed
Repetition frequency	90 kHz
<b>Measurement data</b>	
Distance resolution	1 mm
Detection range	0 ... 50 m
Diffuse reflection	20 %
Angular resolution	0.1 °
<b>Electrical data</b>	

## Part no.: 53800301 – RSL420P-M/CU400P-3M12 – Safety laser scanner

Protective circuit	Overvoltage protection
<b>Performance data</b>	
Supply voltage $U_B$	24 V , DC , -30 ... 20 %
Current consumption (without load), max.	900 mA , (use power supply unit with 3 A)
Power consumption, max.	22 W , For 24 V, plus output load

<b>Interface</b>	
Type	PROFINET
<b>Profinet</b>	
Function	Process
PROFINET device	Device acc. to Spec V2.3.4
GSDML	GSDML acc. to Spec V2.3.2
Profile	PROFINET/PROFIsafe
Conformance class	C
Network load class	III
Security level	1
Switch functionality	IRT-ready 2-port switch acc. to IEEE 802, integrated in connection unit
Port properties	Auto-Crossover Auto-Negotiation Auto-Polarity
I&M	0 - 4
Supported topologies	MRP client SNMP
Safety-related switching signals	1 Piece(s)

<b>Service interface</b>	
Type	Bluetooth
<b>Bluetooth</b>	
Function	Configuration/parametering
Frequency band	2,400 ... 2,483.5 MHz
Radiated transmitting power	Max. 4.5 dBm (2.82 mW), class 2
Type	USB
<b>USB</b>	
Function	Configuration/parametering
Connection	USB 2.0 mini-B, socket
Transmission speed, max.	12 Mbit/s
Cable length	≤ 5m Longer cable lengths are possible using active cables.

<b>Connection</b>	
Number of connections	3 Piece(s)
<b>Connection 1</b>	
Type of connection	Connector
Function	Voltage supply
Thread size	M12
Type	Male
Material	Metal
No. of pins	4 -pin
Encoding	A-coded

**Connection 2**

Type of connection	Connector
Function	PROFINET/PROFIsafe communication, input
Thread size	M12
Type	Female
Material	Metal
No. of pins	4 -pin
Encoding	D-coded

**Connection 3**

Type of connection	Connector
Function	PROFINET/PROFIsafe communication, output
Thread size	M12
Type	Female
Material	Metal
No. of pins	4 -pin
Encoding	D-coded

**Mechanical data**

Dimension (W x H x L)	140.2 mm x 170 mm x 142 mm
Housing material	Metal Plastic , Diecast zinc ,
Lens cover material	Plastic/PC
Net weight	4,300 g
Housing color	Yellow, RAL 1021
Type of fastening	Mounting plate Through-hole mounting Via optional mounting device

**Operation and display**

Type of display	Alphanumeric display LED indicator
Number of LEDs	10 Piece(s)
Type of configuration	Software Sensor Studio
Operational controls	Software Sensor Studio

**Environmental data**

Ambient temperature, operation	0 ... 50 °C
Ambient temperature, storage	-20 ... 60 °C
Relative humidity (non-condensing)	15 ... 95 %

**Certifications**

Degree of protection	IP 65
Protection class	III , EN 61140
Certifications	TÜV Süd
Test procedure for EMC in accordance with standard	DIN 40839-1/3 EN 61496-1
Test procedure for oscillation in accordance with standard	EN 60068-2-6
Test procedure for continuous shock in accordance with standard	IEC 60068-2-29
US patents	US 10,304,307B US 7,656,917 B US 7,696,468 B US 8,520,221 B

**Classification**

Customs tariff number	85365019
eCl@ss 8.0	27272705
eCl@ss 9.0	27272705
ETIM 5.0	EC002550
ETIM 6.0	EC002550

**Dimensioned drawings**

All dimensions in millimeters

Dimensions safety laser scanner with connection unit

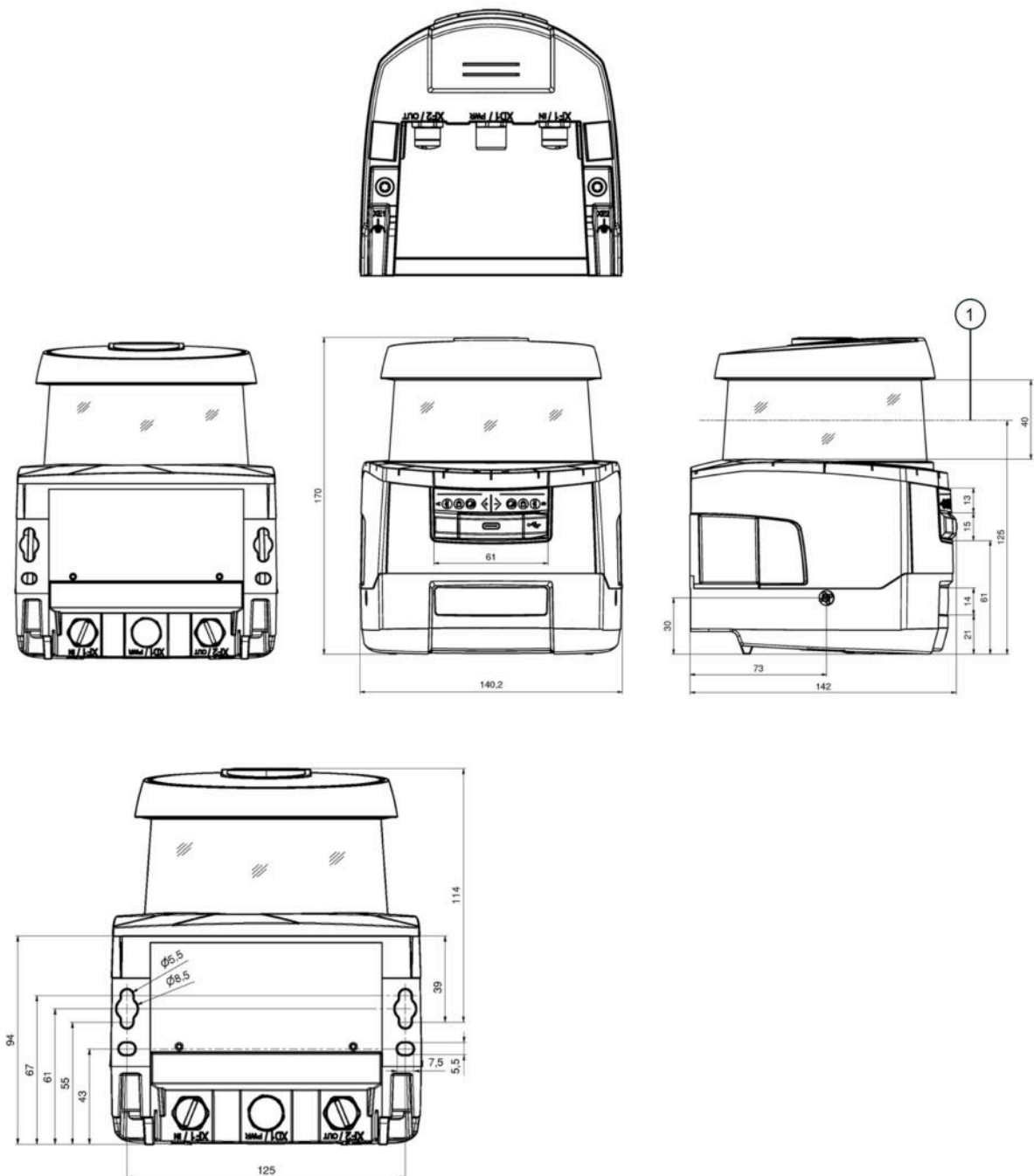

1 Scan level

Mounting dimensions safety laser scanner with connection unit

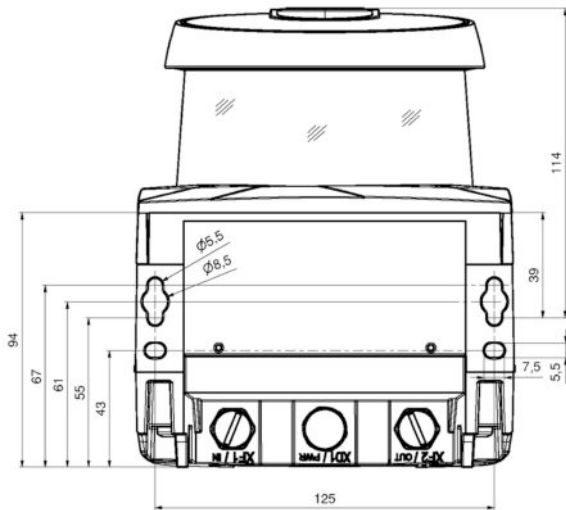

Dimensions of scanning range

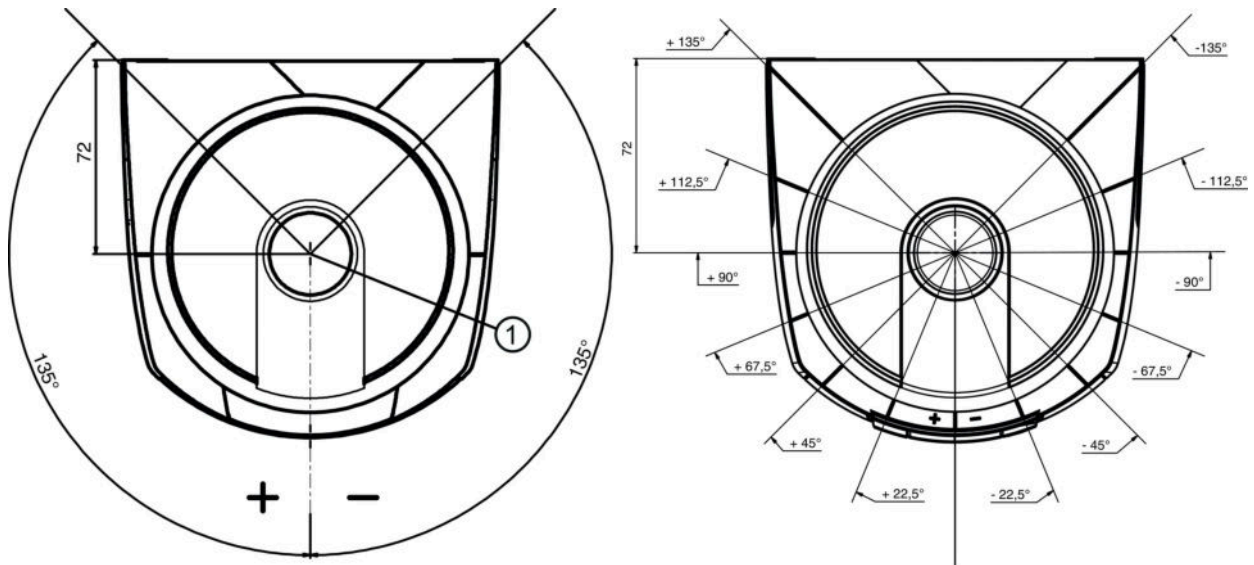

1 Reference point for distance measurement and protective field radius

**Electrical connection**

Connection 1	XD1
Type of connection	Connector
Function	Voltage supply
Thread size	M12
Type	Male
Material	Metal
No. of pins	4 -pin

**Part no.: 53800301 – RSL420P-M/CU400P-3M12 – Safety laser scanner**

Connection 1	XD1
Encoding	A-coded
Connector housing	FE/SHIELD

Pin	Pin assignment
1	+24V
2	EA1
3	0 V
4	EA2

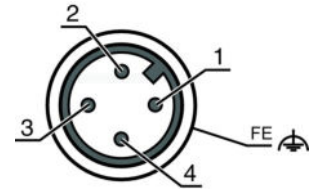

Connection 2	XF1
Type of connection	Connector
Function	PROFINET/PROFIsafe communication, input
Thread size	M12
Type	Female
Material	Metal
No. of pins	4 -pin
Encoding	D-coded
Connector housing	FE/SHIELD

Pin	Pin assignment
1	TD+
2	RD+
3	TD-
4	RD-

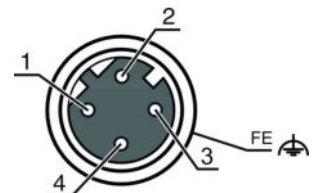

Connection 3	XF2
Type of connection	Connector
Function	PROFINET/PROFIsafe communication, output
Thread size	M12
Type	Female
Material	Metal
No. of pins	4 -pin
Encoding	D-coded
Connector housing	FE/SHIELD

Pin	Pin assignment
1	TD+
2	RD+
3	TD-
4	RD-

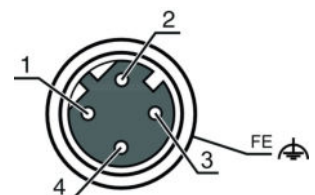

## Operation and display

### LEDs

LED	Display	Meaning	
1	-	Off	Device switched off
		Red, continuous light	OSSD off
		Red, flashing	Error
		Green, continuous light	OSSD on
2	-	Off	RES deactivated or RES activated and released
		Yellow, flashing	Protective field occupied
		Yellow, continuous light	RES activated and blocked but ready to be unlocked - protective field free and linked sensor is enabled if applicable
3	-	Off	Free warning field
		Blue, continuous light	Warning field interrupted
4	-	Off	Four field mode: warning field 3 free
		Blue, continuous light	Four field mode: warning field 3 interrupted
5	-	Yellow, flashing	Four field mode: warning field 2 interrupted
6	-	Off	No function
7	PWR	Off	Device switched off
		Red, continuous light	Error during self test or internal communication problems
		Green, flashing	PROFINET wave function active
		Green, continuous light	Device switched on, supply voltage applied, no internal error
8	PS	Off	PROFIsafe communication not initialized or switched off
		Green, flashing	Device in passive state or PROFINET wave function active
		Green, continuous light	Device on PROFIsafe active
		Red, flashing	PROFIsafe configuration failed
		Red, continuous light	PROFIsafe communication error
9	NET	Off	PROFINET communication not initialized or inactive
		Green, flashing	PROFINET bus initialization or PROFINET wave function active
		Green, continuous light	PROFINET active, data exchange with IO controller active
		Orange, flashing	Ethernet topology error
		Red, flashing	Ethernet configuration failed, no data exchange or exchange of invalid data
		Red, continuous light	Bus error, no communication
10	LNK/ ACT1	Off	No Ethernet link present
		Green, continuous light	Ethernet link active, no current data transmission
		Green/orange, flashing	Ethernet link active, current data transmission
11	LNK/ ACT2	Off	No Ethernet link present
		Green, continuous light	Ethernet link active, no current data transmission
		Green/orange, flashing	Ethernet link active, current data transmission

## Notes

### Observe intended use!

- The product may only be put into operation by competent persons.
- Only use the product in accordance with its intended use.



**WARNING! INVISIBLE LASER RADIATION – LASER CLASS 1**

The device satisfies the requirements of IEC 60825-1:2007 (EN 60825-1:2007) safety regulations for a product of **laser class 1** as well as the U.S. 21 CFR 1040.10 regulations with deviations corresponding to "Laser Notice No. 50" from June 24, 2007.

- Observe the applicable statutory and local laser protection regulations.
- The device must not be tampered with and must not be changed in any way.  
There are no user-serviceable parts inside the device.  
Repairs must only be performed by Leuze electronic GmbH + Co. KG.

## Accessories

### Connection technology - Interconnection cables

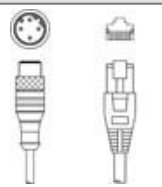
	Part no.	Designation	Article	Description
	50135081	KSS ET-M12-4A-RJ45-A-P7-050	Interconnection cable	Suitable for interface: Ethernet Connection 1: Connector, M12, Axial, Male, D-coded, 4 -pin Connection 2: RJ45 Shielded: Yes Cable length: 5,000 mm Sheathing material: PUR

### Mounting technology - Mounting brackets

	Part no.	Designation	Article	Description
	53800134	BT840M	Mounting bracket	Application: Mounting on chamfered 90° corner Dimensions: 84.9 mm x 72 mm x 205.2 mm Color: Yellow, RAL 1021 Type of fastening, at system: Through-hole mounting Type of fastening, at device: Screw type Material: Metal

## Mounting

	Part no.	Designation	Article	Description
	53800131	BTP800M	Loop guard	Dimensions: 160 mm x 169 mm Color: Black Material: Metal

## Services

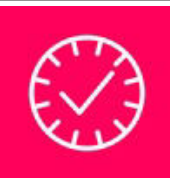
	Part no.	Designation	Article	Description
	S981051	CS40-I-141	Safety inspection "Safety laser scanners"	Details: Checking of a safety laser scanner application in accordance with current standards and guidelines. Inclusion of the device and machine data in a database, production of a test log per application. Conditions: It must be possible to stop the machine, support provided by customer's employees and access to the machine for Leuze employees must be ensured. Restrictions: Travel costs and accommodation expenses charged separately and according to expenditure.

Part no.: 53800301 – RSL420P-M/CU400P-3M12 – Safety laser scanner

	Part no.	Designation	Article	Description
	S981047	CS40-S-141	Start-up support	Details: For safety devices including stopping time measurement and initial inspection. Conditions: Devices and connection cables are already mounted, price not including travel costs and, if applicable, accommodation expenses. Restrictions: Max. 3 h., no mechanical (mounting) and electrical (wiring) work performed, no changes (attachments, wiring, programming) to third-party components in the nearby environment.

**Note**

A list with all available accessories can be found on the Leuze electronic website in the Download tab of the article detailed page.