

Y-adapter audio cable 3.0mtr RYPC030

YPK420 Microphone cable

Twin Microphone Cable, O.D. 4.3 mm, 0.22 mm² / AWG 24

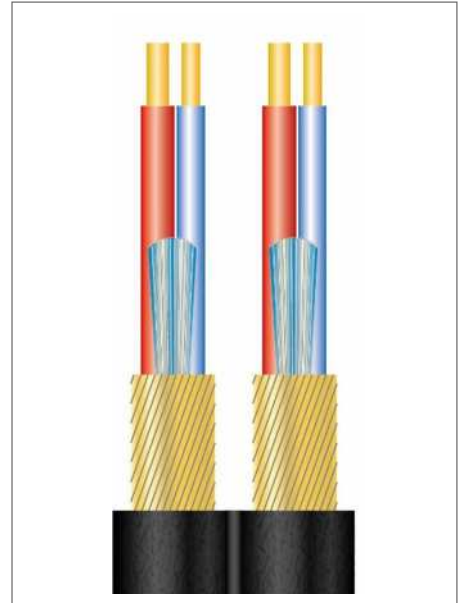
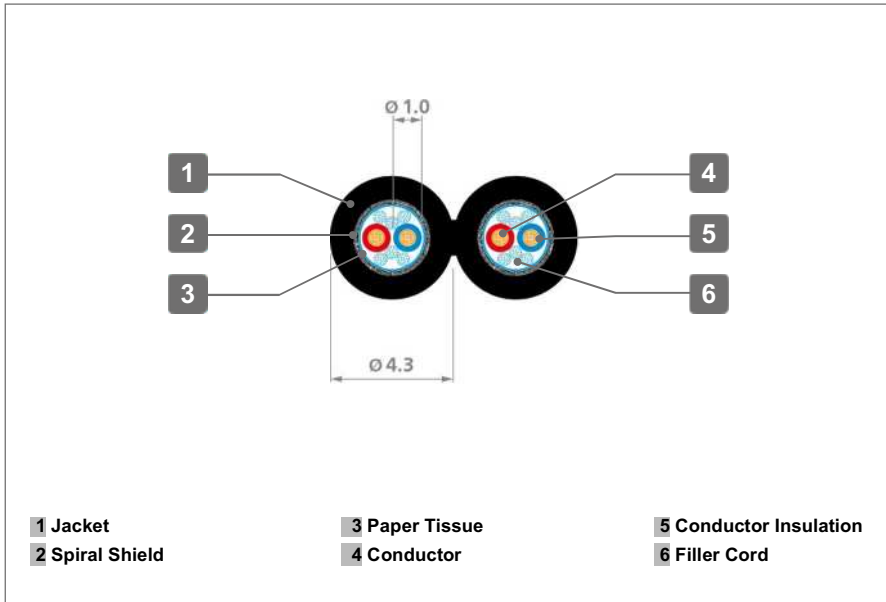

MECHANICAL SPECIFICATION

Composition of conductor	28 x 0.10 mm / 28 x AWG 38 bare annealed copper, OFC standard
Conductor insulation	LD-PE Ø 1.0 mm
Conductor color	Red & Blue
Composition of core	2 twisted cores 40 mm one turn, left hand
Spiral shield	56 x 0.10 mm bare annealed copper, OFC standard Coverage > 90 %
Overall jacket material	PVC with restricted Substance: Cadmium: < 5 PPM ("Cadmium free") Lead: < 50 PPM Mercury: < 2 PPM Chromium: Not contained
Jacket colour	Black (other colours on request)
Overall diameter	Ø 4.3 mm tolerance: +/- 0.2 mm
Working temperature - Mobile - Fixed	-5 °C to +70 °C -20 °C to +70 °C
Cable Printing	- Standard cable print - Customer cable print on request

ELECTRICAL SPECIFICATION

Conductor DC resistance	≤ 80 m [∧] / m – 20 °C
Screen DC resistance	≤ 40 m [∧] / m – 20 °C
Insulation resistance	> 1 G [∧] / km – 20 °C, 500 V _{DC}
Capacitance Conductor to Conductor	≤ 80 pF / m – 1 KHz
Capacitance Conductor to Screen	≤ 140 pF / m – 1 KHz
Test voltage: Conductor to Conductor	500 V eff – 50 Hz, 1 Minute
Test voltage: Conductor / Screen	1.000 V eff – 50 Hz, 1 Minute

2 x 1/4" Phone Plugs, 2-pole

Y Series

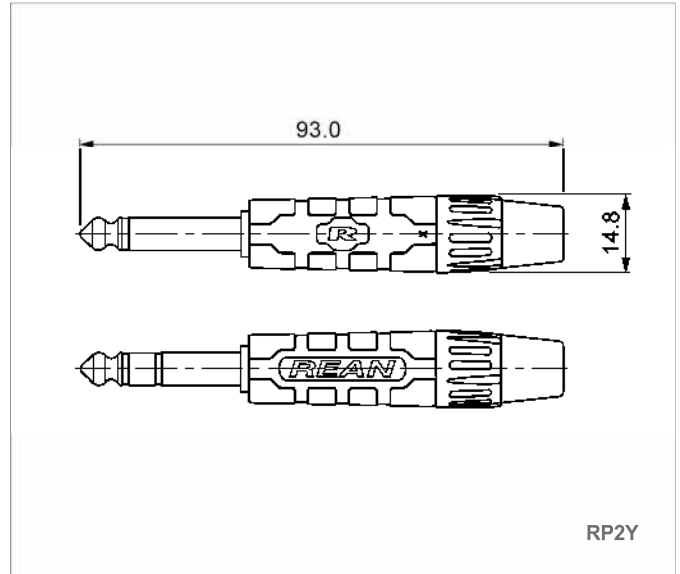

FEATURES

- *Slim and ergonomic design – space saving and convenient to handle*
- *Rugged zinc diecast shell – long lasting and reliable*
- *Chuck type strain relief – best cable retention, easy to assemble*
- *Rubber boot kink protection – guarantees best cable protection and offers long cable life*

CONNECTOR

Type No.	Description
RP2Y	1/4" plug, 2-pole, nickel plated housing and nickel plated plugfinger

REAN[®]

1/4" Phone Plugs

TECHNICAL DATA

ELECTRICAL

Contact resistance	< 10 m \wedge
Dielectric strength	> 1 kV dc
Insulation resistance	> 1 G \wedge
- initial	
- after damp heat test	> 0.1 G \wedge

MECHANICAL

Lifetime	> 1'000 mating cycles
Lateral load capacity	> 4 Nm
Strain relief force	> 70 N
Cable O.D. range	4.0 - 7.0 mm
Wiring type	Soldering
Max. wire size	1 mm ² / AWG 18

MATERIAL

Shell (housing)	Zinc diecast
Shell plating	Nickel
Insert	Nylon
Contacts	Brass
Contact plating	Ni
Strain relief (chuck)	POM
Bushing	Nylon
Boot	PVC

ENVIRONMENTAL

Operating temperature	-20 °C to +70 °C
Solderability	Complies with IEC 68-2-20

Data subject to change without prior notice. © 2017 REAN® is a registered trademark of the Nedrick Group. ALL RIGHTS RESERVED.

REAN®

2 x Phono "RCA / Cinch" Connector

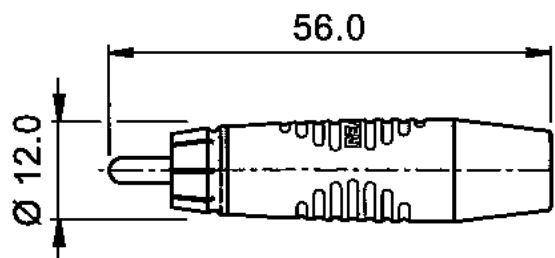

FEATURES

- *Attractive and slim design with ergonomic finger groove – space saving and convenient to handle*
- *Rugged zinc diecast shell – long lasting and reliable*
- *Chuck type strain relief – best cable retention, easy to assemble*
- *Gold plated contacts – for best conductivity and durability*
- *Rubber boot kink protection – guarantees best cable protection and offers long cable life*

CONNECTOR

Type No.	Description
RF2C-AU-0	RCA plug, nickel shell, gold plated contacts, black boot
RF2C-AU-2	RCA plug, nickel shell, gold plated contacts, red boot

REAN[®]

Phono "RCA / Cinch" Connector

TECHNICAL DATA

ELECTRICAL

<i>Rated current</i>	<i>depends on mating connector</i>
<i>Contact resistance</i>	<i>depends on mating connector</i>
<i>Insulation resistance</i>	$\geq 1 \text{ G}\Omega$
<i>Dielectric strength</i>	1 kV dc

MECHANICAL

<i>Lifetime</i>	> 1'000 mating cycles
<i>Insertion / withdrawal force</i>	$\leq 20 \text{ N} / \geq 10 \text{ N}$
<i>Cable O.D.</i>	4.0–6.0 mm

MATERIAL

<i>Contacts</i>	Brass (CuZn39Pb3)
<i>Contact plating</i>	AU
<i>Insert</i>	PA 6 30% GR
<i>Shell (housing)</i>	ZnAl4Cu1
<i>Shell (plating)</i>	Ni
<i>Strain relief</i>	PA 6

ENVIRONMENTAL

<i>Operating temperature</i>	-20°C to +70°C
<i>Solderability</i>	complies with IEC68-2-20

Data subject to change without prior notice. © 2017 REAN® is a registered trademark of the Neutrik Group. ALL RIGHTS RESERVED.

REAN®